

- Build your buildings from 1/4" Plywood
- Decorate with purchased trims or make your own trims
- Add commercial windows and doors or build your own from 1/8" thick hardwood or balsa. Garden Towns Doors and Windows patterns sold separately.
- Optional: Add lights, using manufacturers instructions

Scaled and easy to read patterns and instructions.

2 Story Flat Roof  
Yard and Garden Buildings  
Compatible with Garden Railroads  
or a delight for any child's collection

**Patterns Include Building:**

Walls, Roof, Foundation  
Porch with optional rail and signs.

Overall Dimensions  
Foundation: 10" x 20"  
Building: 10" x 15-1/2"  
Walls: 10" high with 12-1/2" Front

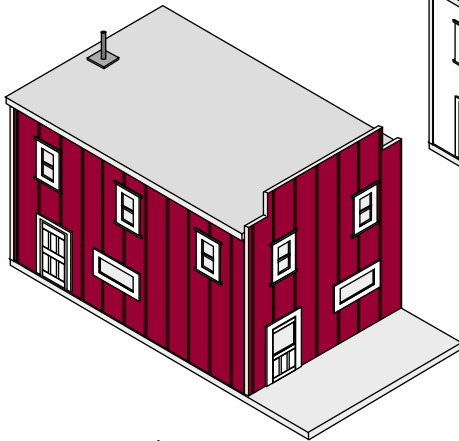

Saloon  
(with and without porch)

There are six buildings illustrated with specific walls. Walls shown are not inclusive. You can also "mix and match" the wall arrangements to design your own building. Foundation provides space for plain sidewalk or porch addition.

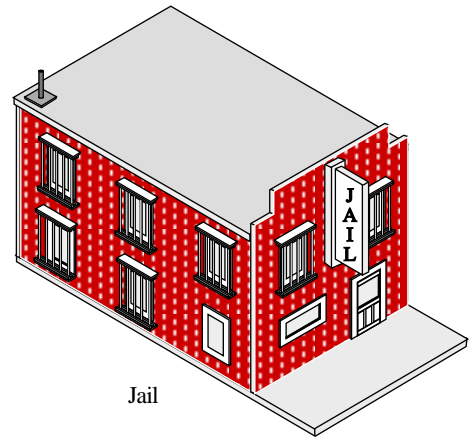

Jail

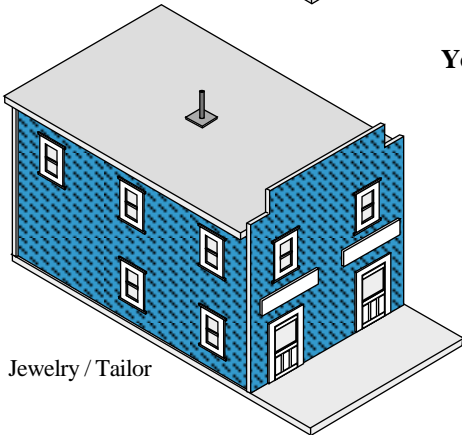

Jewelry / Tailor

Choose between two types of fronts: Plain or Stepped Top Fronts are interchangeable with door and window placements.

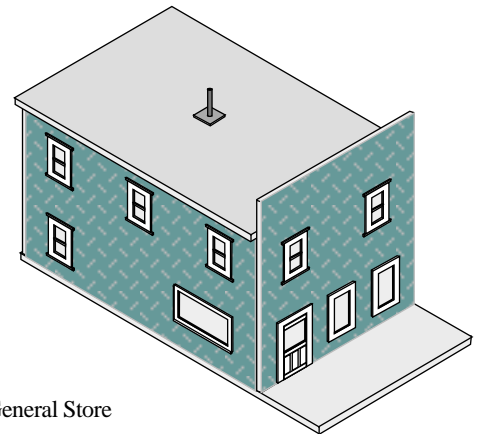

General Store

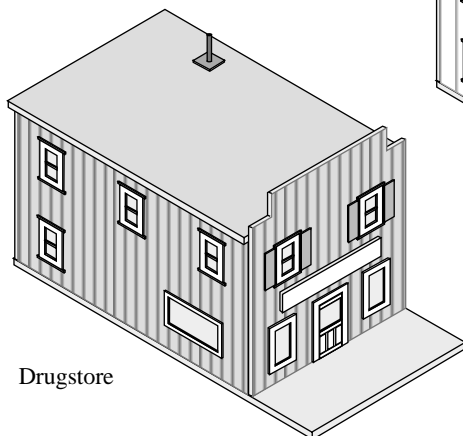

Drugstore

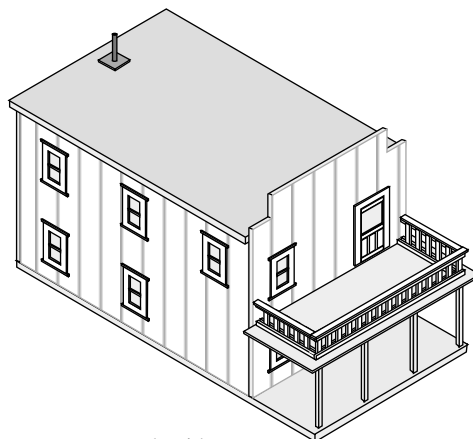

Porch with rail for second floor balcony

Hotel

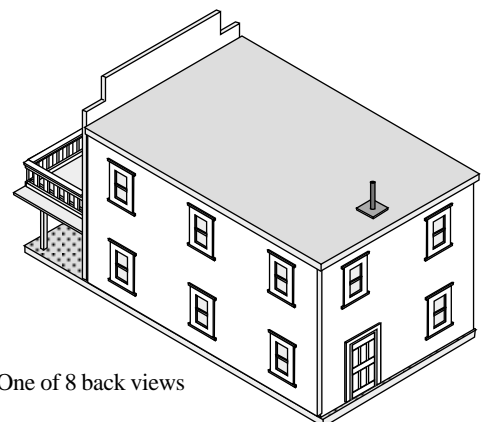

One of 8 back views

## Introduction

Thank you for purchasing the Garden Town pattern. As a background, the Garden Town houses and buildings were inspired by the Garden Scale Railroads. We wanted to build small towns as backdrops for the trains. After building several prototypes, we discovered that they are actually fun to make. They don't even have to have a railroad to accompany. Depending on your choices, each of the houses can be different. They can be an addition to your flower garden. Or a backdrop toy for a child. If you are building yours for outside display, do keep in mind the elements. Houses will have to be sealed with polyurethane or varnish to minimize weather damage.

Please take a few minutes and go over the Steps to Building Your Building before you begin.

We hope you enjoy your project!

---

## Table of Contents

<b>Before You Begin</b>	
<b>Steps to Building Your Building</b>	3
<b>Tools and Supplies</b>	
General	4
Door and Window Requirements	5
Working With Small Items	6
Building and Porch Layout	7
Top Rail for Porch Layout	
2 Signs to Make	
Frame	8
<b>Planning the Building</b>	
Buildings to Choose From	9
<b>Walls - Door and Window Placement</b>	
Front Walls	12
Side Walls	13
Back Walls	15
<b>Porches -</b>	
Patterns and Assembly	16
Top Rail Patterns and Assembly	19
<b>House Patterns</b>	24
<b>Assembly</b>	
Walls	26
Building	28

Planning the Building - Decide which building you will build. If you use one of the buildings we have illustrated, we have indicated which walls to use.

Planning the Walls section is to be used as a guide for placement of doors and windows. Although our illustrations show the dimensions for Garden Town Doors and Windows, you can use the illustrations as guides, adjust your measurements and install purchased doors and windows.

#### Porches - Optional

Three or four post porches to choose from, depending on where the door is placed.

#### Doors and Windows

**Opening Type Doors** -If you use commercially purchased doors, you will have to cut into the building frame. Our illustrations show how to make the opening. The size of the opening will depend upon the doors and windows you purchase and the instructions which come with them.

**Non-Opening Doors**-Such as Kiva Design Garden Town Doors and Windows, which you build yourself, you can build a simple "box frame" for the building. The window openings will be above the frame and the 1/8" thick doors will fit into the 1/4" walls.

#### Keep in mind:

A building should have a a minimum of 2 exits (doors). If the set up is duplex, each unit should have 2 doors. An example is the Shoe/Western Union Building. Door and window openings will need to be at least 1" from the sides and 1" from the roofline so they don't interfere with the building frame behind the walls.

#### **Before You Begin**

##### Tools and Supplies -

##### Layout

Record how much 1/4" Plywood you will need to build the building you want.

##### Door and Window Requirements"

Record how many you will need. Decide if you want to purchase or build. Record supplies you will need.

##### Frame

Record how many feet of 1" Furring Strip you will need

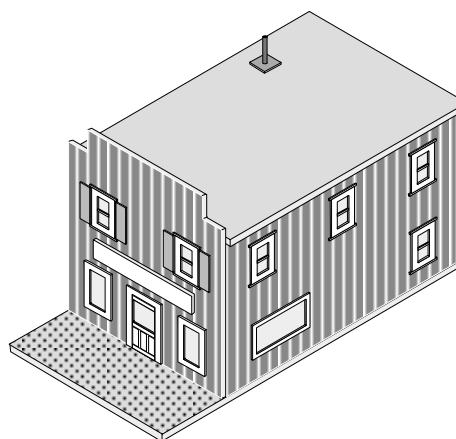

#### Optional - Items to consider from the hobby store:

**Lights** - Add Lights according to manufacturers instructions. We suggest that you use screws instead of nails when attaching the roof to allow future access to the wiring and bulb.

You can buy scaled wood shingles for your roof as well as assorted other detailed items. You can make your own signs with help from a stencil or the stick-on letters and numbers available.

#### **Ready to Build**

Determine which patterns you will need:

- 1- Building Front ( Straight or Stepped)
- 2- Side Walls
- 1- End Wall
- 1 -Roof
- Porch, as required

- Cut out all wood, according to Pattern dimensions.
- Cut Furring Strips for frame -  
see Tools and Supplies-Frame
- Measure and cut out door and window openings from the walls, as needed (see Assembly - Walls).
- Sand off any rough edges.
- Optional: Paint or stain the walls. Dings can be touched up later. You may prefer to do this step after assembly is completed.
- If used, assemble the Porch, per individual instructions.
  
- Assemble the building (see Assembly - Building).

If you are placing your house outside, be sure to protect it with a good seal of polyurethane or varnish.

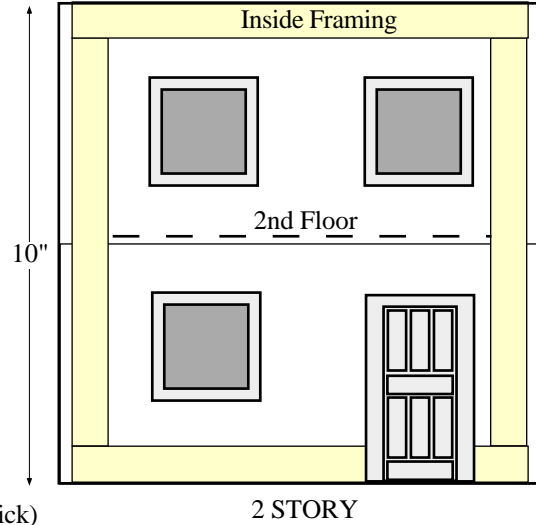
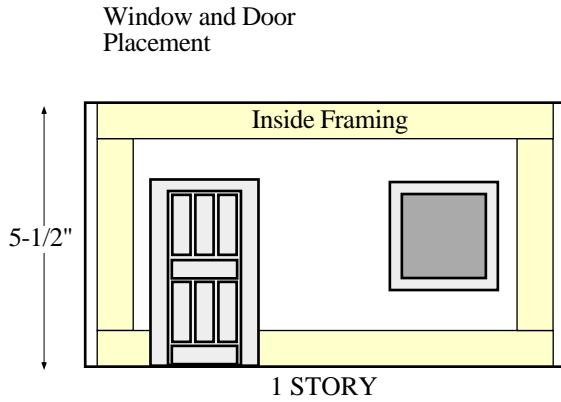

- Buildings and porches are constructed from 1/4" thick plywood
- Framing for the walls is made from 1" Furring strips (nominally 3/4" thick)
- Garden Town Doors and Windows are made from 1/8" thick Balsa wood or Hardwood and plastic glazing for the window panes
- Windows and doors have to be at least 1" from sides and top (to clear inside building frame)
- Doors are placed at floorline
- Floorline on 2nd floor will be 5-1/8" from bottom of wall
- Windows are placed with tops level with doors (some exceptions)

For a few hints to experiment with on the wall finishes, see "Simulated Patterns" in our free **Food for Thought** brochure.

**Tools Needed for Building**

- Saw (for cutting small wood pieces, a jig saw or coping saw)
- Hammer or Stapler or Air Gun
- Clamps
- T-Square
- Level
- Ruler and Pencil (We prefer see-thru rulers with grids for the small pieces)
- Drill

**If you are making Doors & Windows from Balsa wood**

- X-ACTO knife and metal ruler for guide
- Optional:**
- Ruler - the plastic see-thru kind with 1/8" grid is a plus
- Balsa stripper - This little gizmo is used for making various widths of uniform strips from balsa wood. You can set it to cut small widths, (1/8", 1/4", 1/2" etc.) It saves a lot of time if you prefer to cut your own strips. Of course you can buy the strips "ready made" at a higher price.
- Clamps (small) - The X-ACTO clamps for small pieces are very handy.

**Supplies Needed - General**

- 5/8" Staples or Brads
- 1" #6 Wood Screws, Flat Head
- Small 3/8" - 1/2" wood screws
- 2" Finishing Nails
- Wood Glue suitable for outdoors
- Paint or Stain - We suggest the water based Acrylic Paints found in a multitude of colors in arts and crafts stores.
- Sealer - Water Base Varnish found with the acrylic paints or a sealer such as polyurethane.
- Optional: Caulking for sealing porches, roofs, etc.

Guide for 1" x 1" x 8' Furring Strips		
1	8'	96"
2	16'	192"
3	24'	288"
4	32'	384"
5	40'	480"

**Specific Building Supplies**

For Details  
See Page

<b>1/4" Plywood</b> (No. of Sheets)	48" x 27" (1) 4' x 4'	7
<b>1" x 1" Furring Strips (nominally 3/4" x 3/4")</b> Totals	126"	8
<b>Purchased Doors &amp; Windows</b> or <b>1/8" thick Balsa or Hardwood for : Doors and Windows</b>		5
<u>Optional Strips for porch frame &amp; posts</u> (1) 1/4" x 1/2" x 36" Strip for frame (1) 1/4" square x 18" Strip for posts		16 & 17
<u>Optional Top Rail for Porch</u> (1) 1/8" x 3/8" x 18" strip (3) 1/8" x 1/4" x 36" strips		7
<b>Clear Plastic Glazing for Windows</b> 8" x 10" Sheet	1	5
<b>1/8" Wood Dowel</b> For Rooftop Pipe	1"	28
Optional Small Parts Frame - Page 6 1/4" Plywood - No extra needed 1" x 1" Furring Strips - Add 52"		

**Doors and Windows**

Option: You can purchase ready-made doors and windows which actually open. For example, Grandt Line carries a well made and ready to paint plastic selection for Scale 1:24.  
or  
you can make your own (Garden Towns Doors and Windows Patterns by Kiva Design) These doors and windows are also 1/24 scale, but are a little larger overall for ease in building. They are non-opening (no hinges).

The following are samples represented for the scaled dimensions.  
Buildings are illustrated with the Kiva Design Samples. Neither of the samples are inclusive all all doors and windows available.

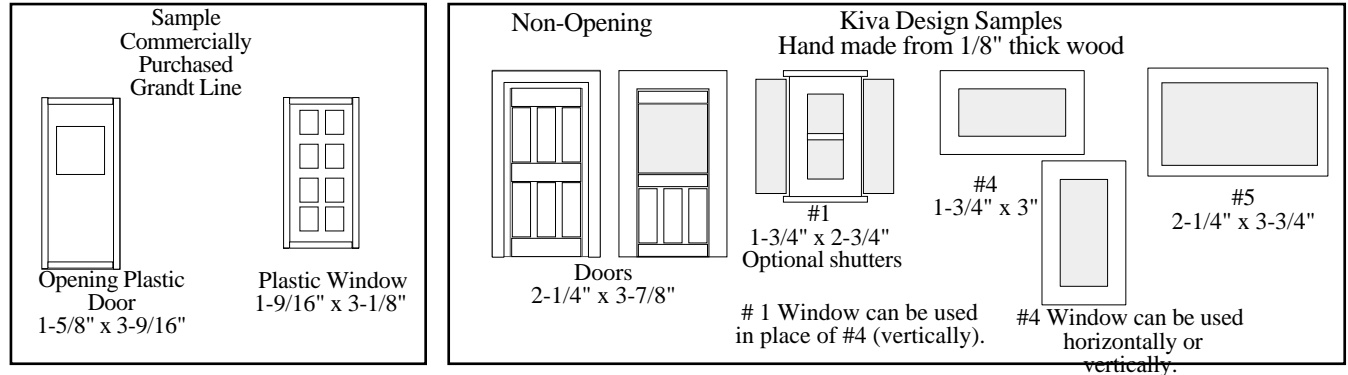

•Purchased Doors and Windows, as required

OR

•1/8" thick Balsa wood or Hardwood for Doors and Windows:

Details below

Building	Doors		Windows			4 x 36" Boards or complete assemblies	Optional: Cut basic frames from boards and purchase ready made strips to cut					Dowel for Jail Bars 1/8" Dia.	
	#4	#5	#1	#4	#5		4 x 36" Boards for basic frames	Strips					
							1/8"	1/4"	3/8"	1/2"	*5/8"		
Saloon	1	1	10	2	-	3	1	8"	140"	58"	8"	50"	-
Jewelry / Tailor	2	2	14	-	-	3	1	11"	174"	94"	15"	70"	-
Drugstore	-	2	12	2	1	3	1	9"	188"	62"	5"	60"	-
Hotel	-	3	17	-	-	4	1	13"	219"	90"	8"	85"	-
Jail	-	2	-	14	-	3	2	126"	174"	20"	5"	-	228"
General Store	-	2	11	2	1	3	1	9"	177"	59"	5"	55"	-
							*5/8" Strips are for shutters						

•Clear Plastic for Windows

8" x 10" Sheet  
(from hobby shop framing area)

Refer to your Kiva Design Door and Window Series, page 57 for yields in strips (number of strips to purchase)

\*Doors and windows shown for the building can be made from the number of boards indicated. However, "we" personally always buy one extra board in the unlikely event that we'll need it to redo our "errors". Left-overs are saved for the next project.

### Assembly Frame for Small Items

#### Patterns

Cut from plywood -1/4" thick or any scrap

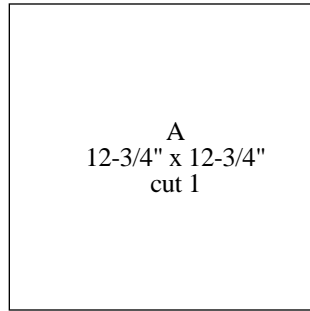

Cut from 1 x 1 Framing (nominally 3/4" x 3/4")

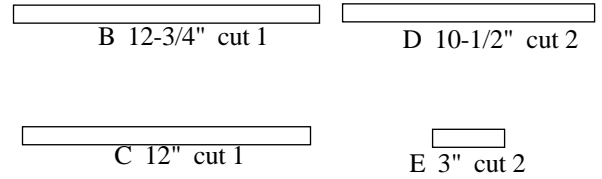

#### Assembly

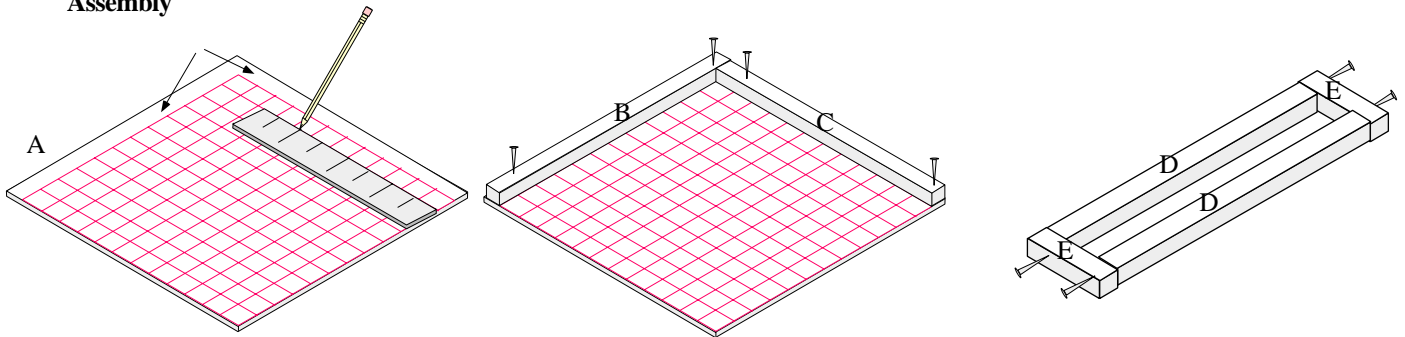

- Using pencil or pen and ruler, draw lines 3/4" inside of 2 adjacent sides of the base. The frame will be placed in this area. From those 2 lines, draw lines at 1" intervals, forming a 1" grid.

- Nail and glue frame parts B and C in place, as shown, maintaining a square corner.

- Using glue and nails, assemble the frame "push bar", as shown. Again, make sure that the corners are square.

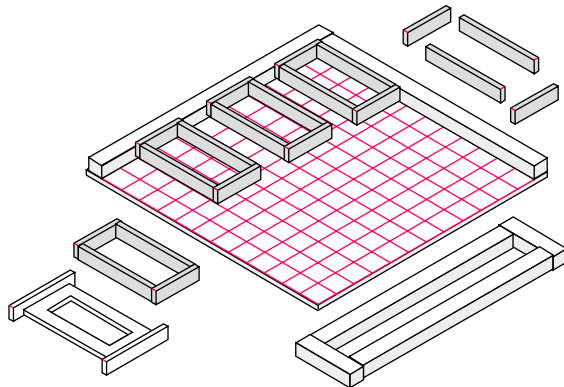

- Glue parts and assemble inside the frame. The grid will help you keep the pieces straight. You can assemble several "like" pieces at one time.

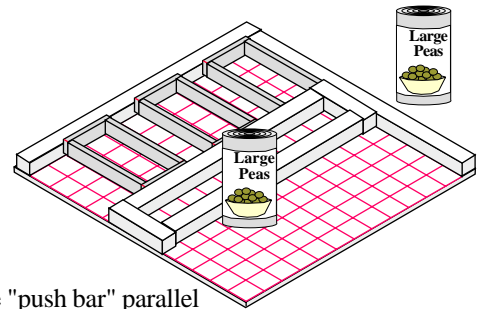

- Keep the "push bar" parallel to side C and push it firmly against the assembled parts. Use anything with weight to hold the push bar in place until parts are dry. Canned goods you didn't want for dinner work well.

### Trimming 1/8" Balsa wood or hardwood

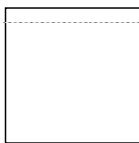

- Using ruler and pencil make a line 1/8" from the inside edge to be mitered

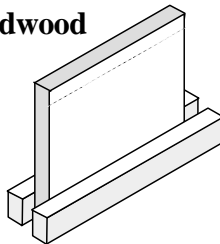

- Stabilize the piece to be mitered with a clamp or other means

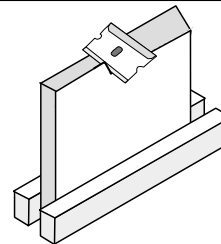

- With blade, carefully trim from the top outside to the marked line. Alternately, the piece can planed or sanded.

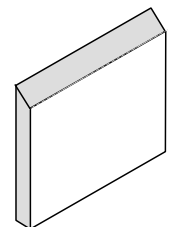

Trimmed on the inside

**Layout for Building and Porch Cut from 1/4" Plywood 27" x 48"**

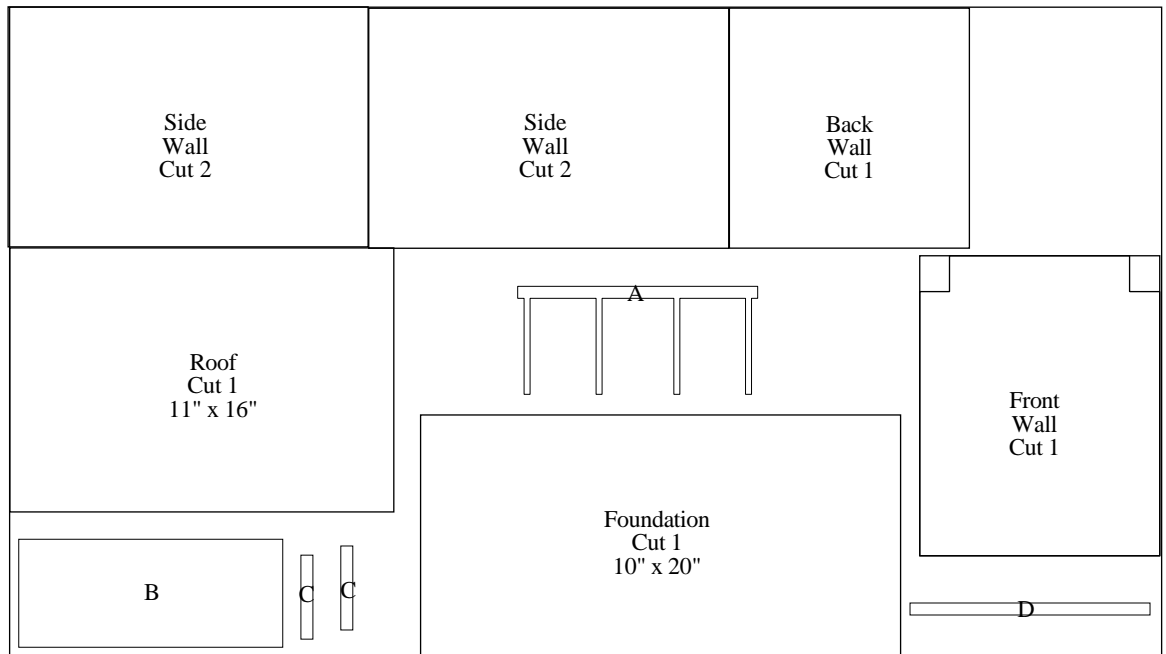

**Layout - Top Rail for roof Cut from 1/8" Thick Balsa Wood or Hardwood 4" X 10"**

You may wish to purchase "ready made" strips  
90" - 1/4" Strips  
18" - 3/8" Strips

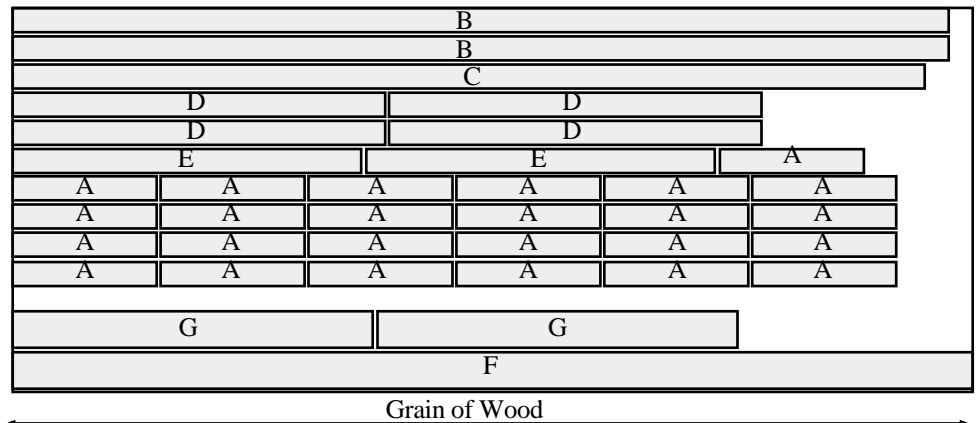

**2 Signs you can make from scrap wood. Make from 1/4" Plywood or 1/8" Hardwood**

We suggest purchasing the stick-on letters found at hobby store.

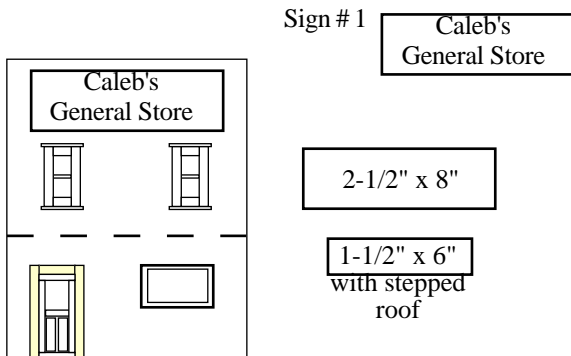

Paint sign and let dry.  
Add letters and seal entire sign with polyurethane.  
Glue in place.

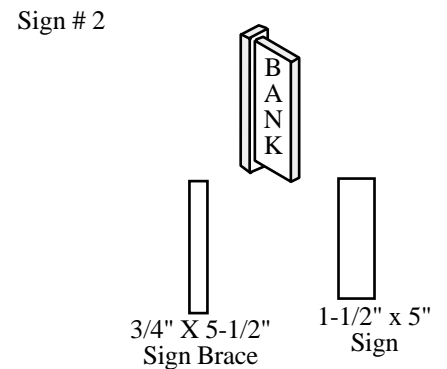
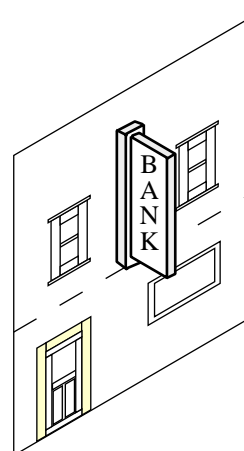

Attach sign to brace with glue. Let dry.  
Paint sign and brace and let dry.  
Add letters to sign.  
Seal entire sign with polyurethane.  
Glue brace to wall.

**The Frame**

You will need to build a frame for which to attach the walls.

Non-Opening Doors

If your building will have doors which do not physically open, you can build a simple box for your wall braces. The windows and doors will fit into the walls.

**Build this frame if you are using Garden Town Doors and Windows**

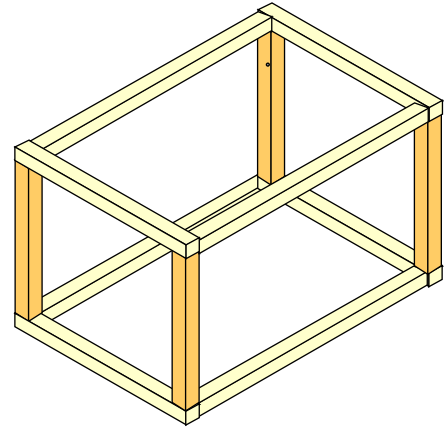

Assembly instructions are on page 29

Opening Doors

If you are installing doors which do physically open, you will be cutting out openings in the bottom brace.

**Build this frame if you are using purchased doors which open**

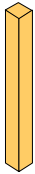
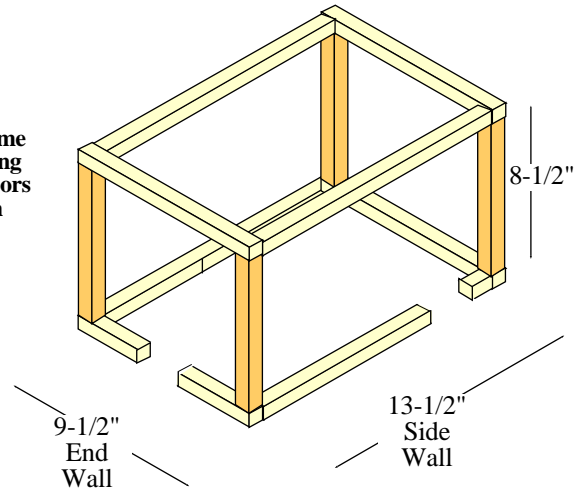

Vertical Braces for 2 Story Houses are 8-1/2"

Framing

Cut from 1" Furring Strips (nominally 3/4" square\*)

4 @ 9-1/2"	38"
4 @ 13-1/2"	54"
4 @ 8-1/2"	34"
<b>Total</b>	<b>126"</b>

Conversion Inches = Feet	
12"	1'
24"	2'
36"	3'
48"	4'
60"	5'
72"	6'
84"	7'
96"	8'
108"	9'
120"	10'
132"	11'
144"	12'
156"	13'
168"	14'
180"	15'
192"	16'
204"	17'
216"	18'
228"	19'
240"	20'

\*If your framing material is a different size than 3/4" square, adjust your first two lengths to fit the Diagram for Frame Assembly shown on page 29.



SALOON

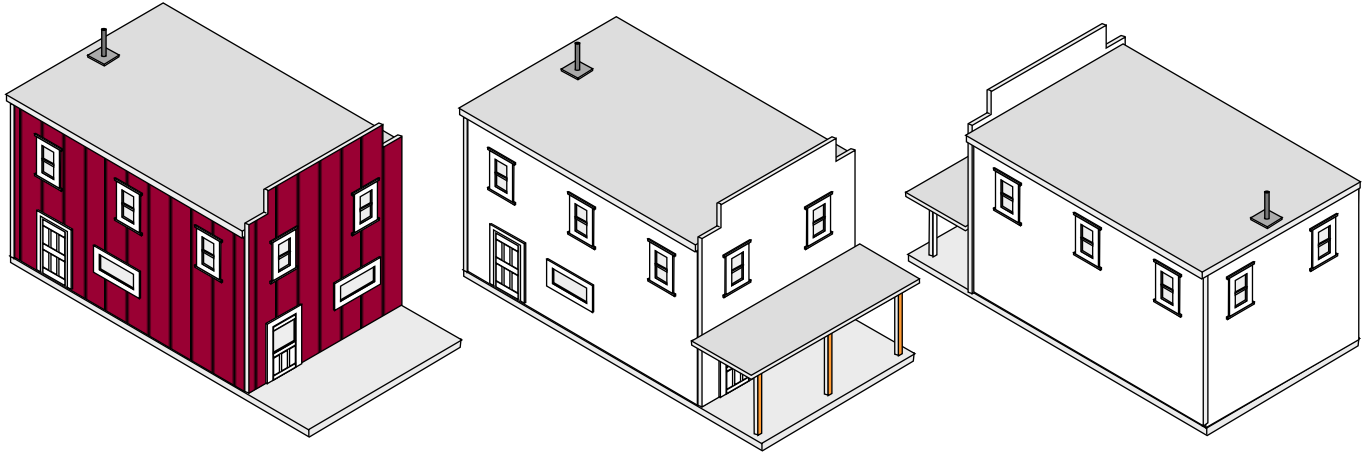

Walls shown for Saloon

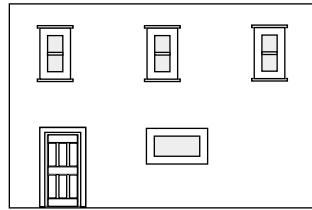
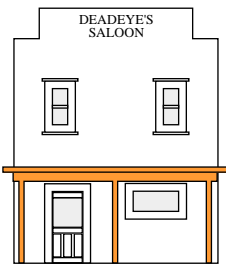

S9

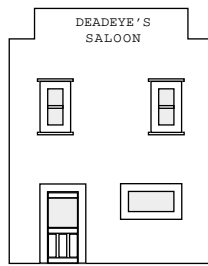

F2

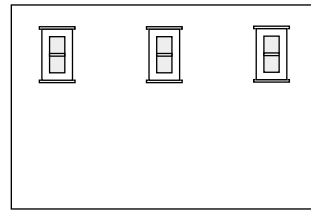

S1

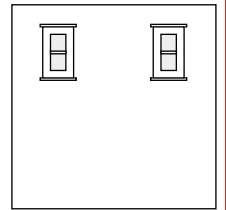

B7

JEWELRY / TAILOR

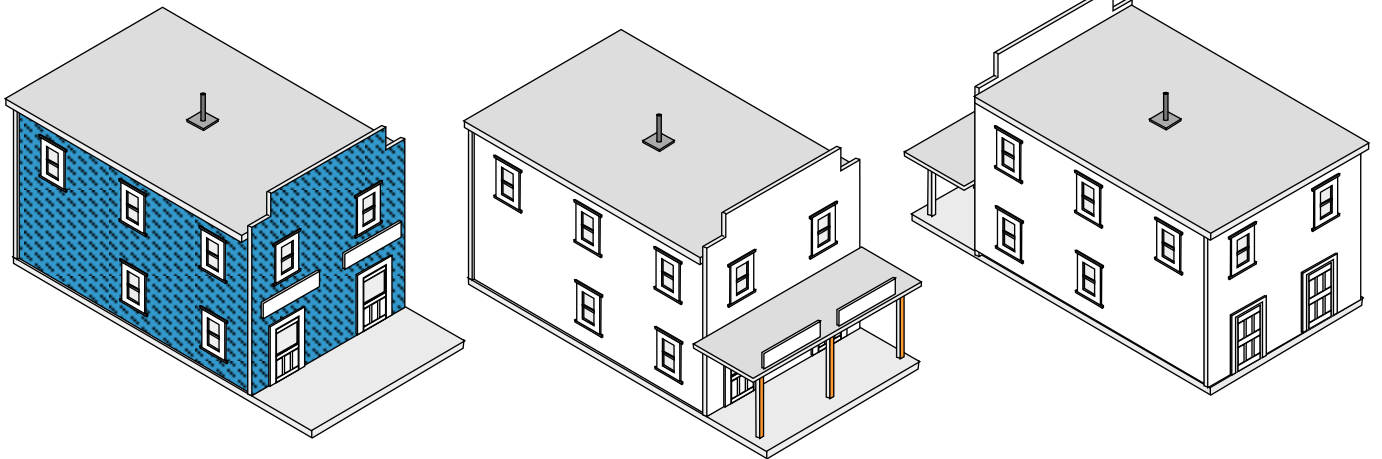

Walls shown for Jewelry / Tailor

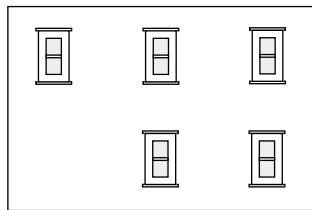
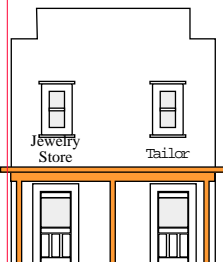

S3

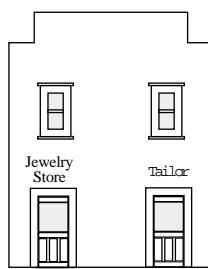

F1

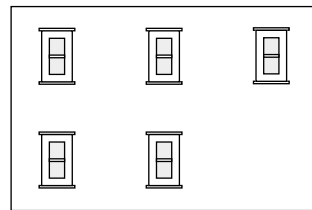

S2

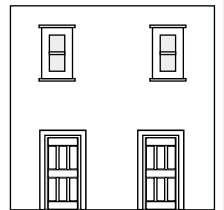

B1

DRUGSTORE

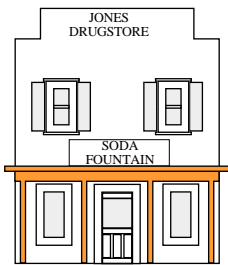
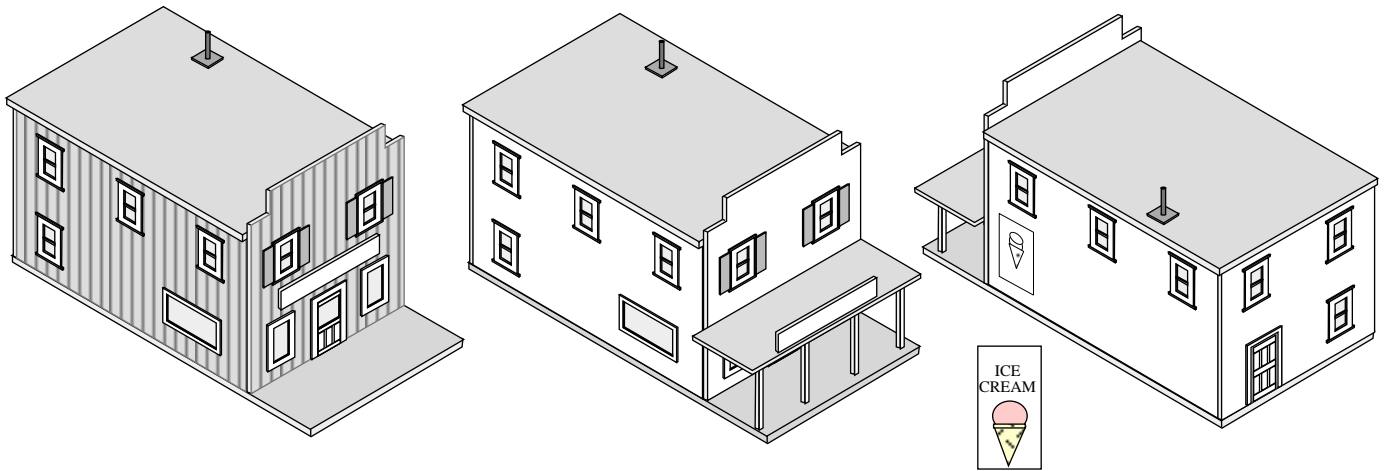

Walls shown for Drugstore

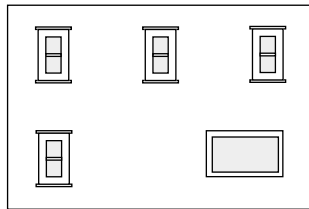

S6

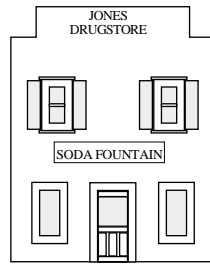

F4

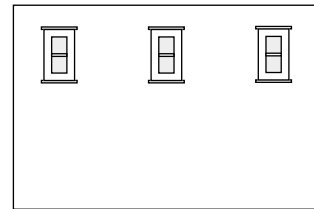

S1

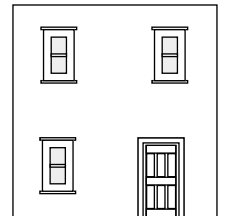

B5

HOTEL

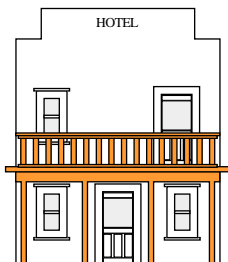
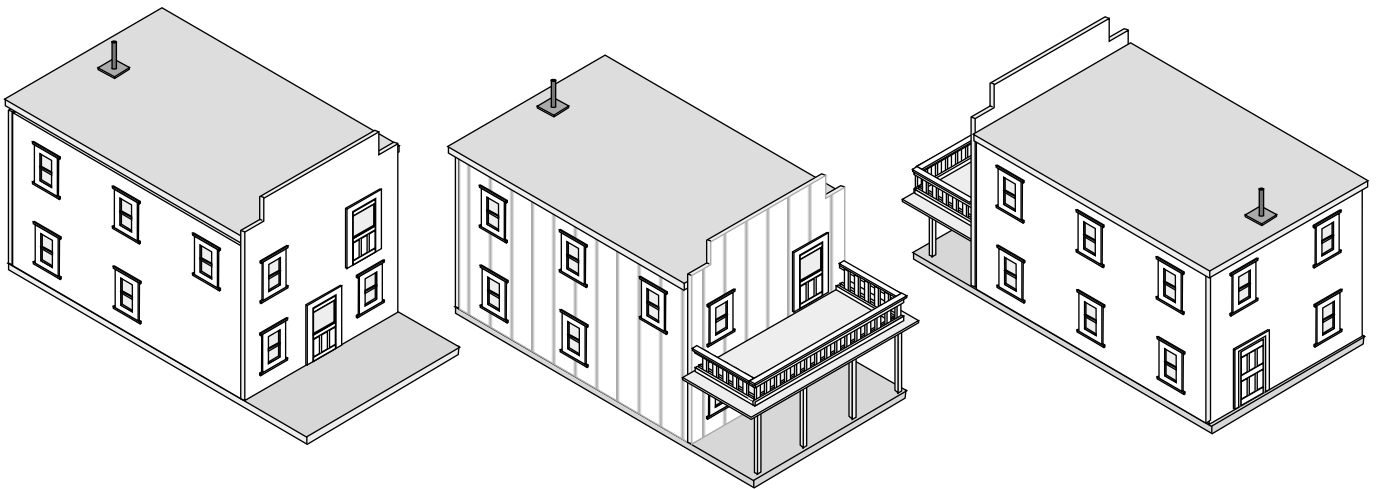

Walls shown for Hotel

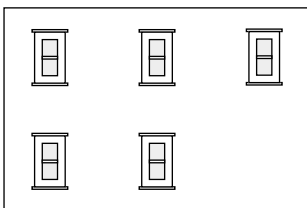

S3

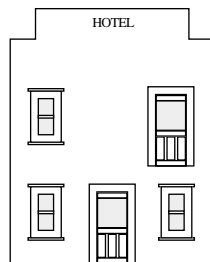

F6

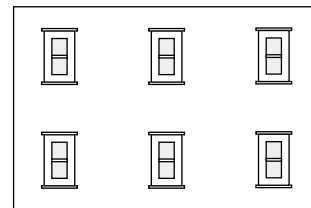

S4

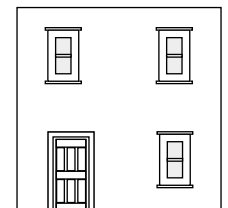

B4

JAIL

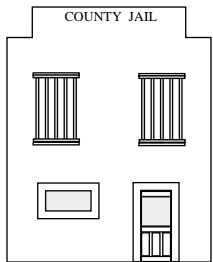
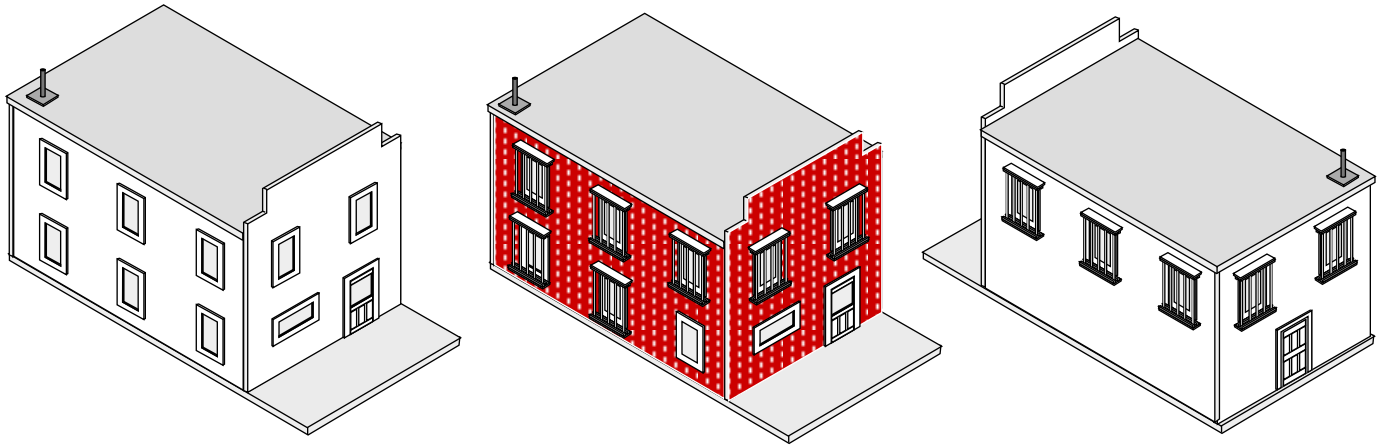

Use #4 Window on jail  
and  
the bars

Walls shown for Jail

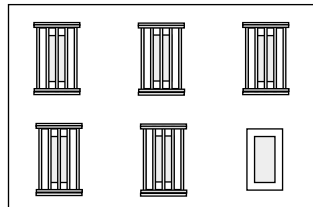

S4

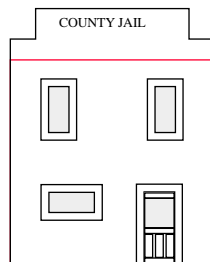

F3

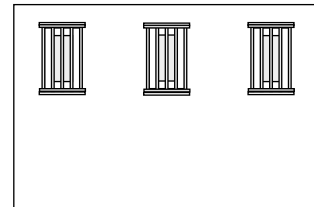

S1

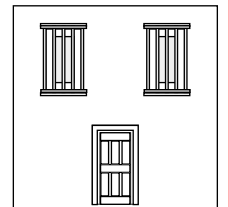

B6

GENERAL STORE

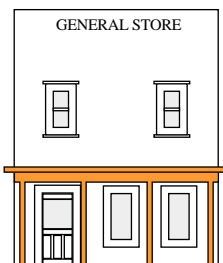
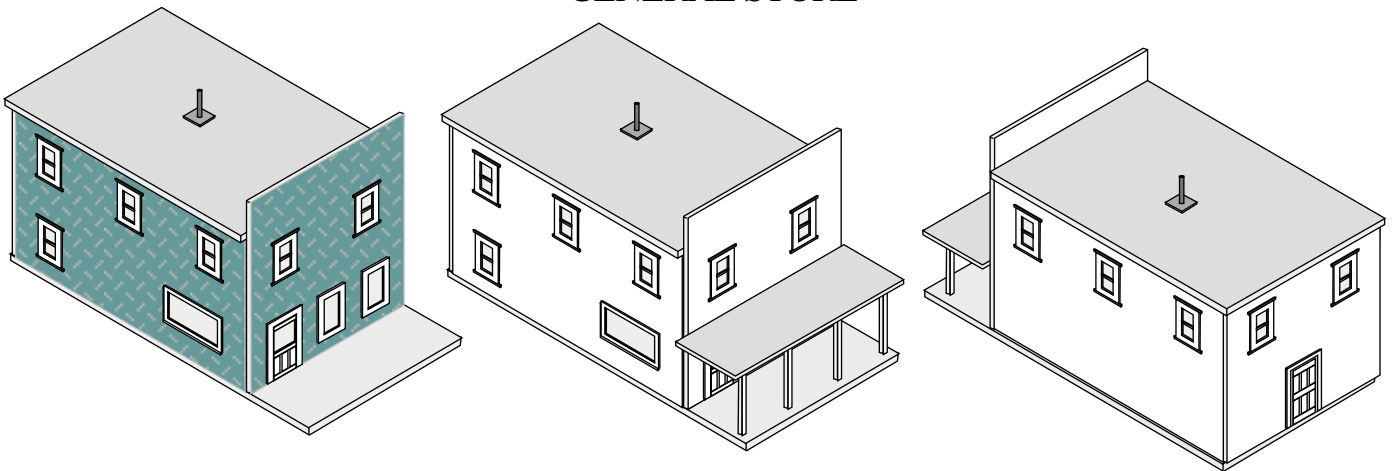

Walls shown for General Store

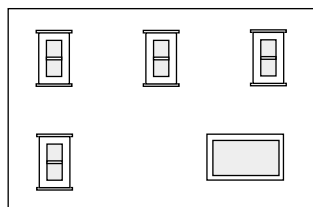

S6

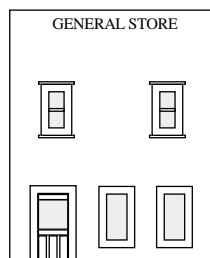

F5

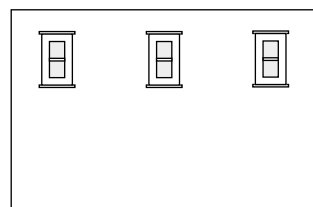

S1

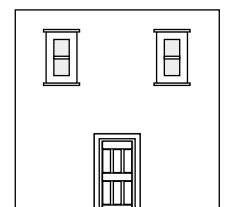

B6

1-1/2" Spacers indicate measurement from side of wall to door or window frame.  
This measurement is the guide for Kiva Design Door & Window templates. Detail on page 26.

**Front Walls**

Choose between the two types of fronts (Plain or Stepped)  
Both are the same overall size. The door and window placements will be the same.

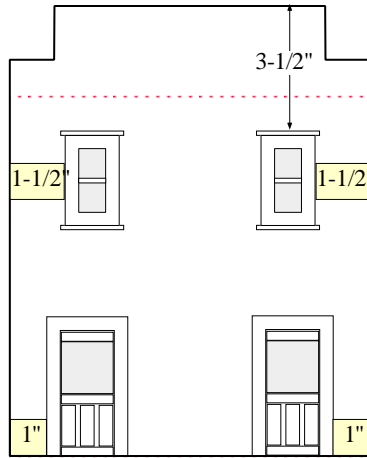

**F1**

Shown: Window # 1  
Can Use # 4

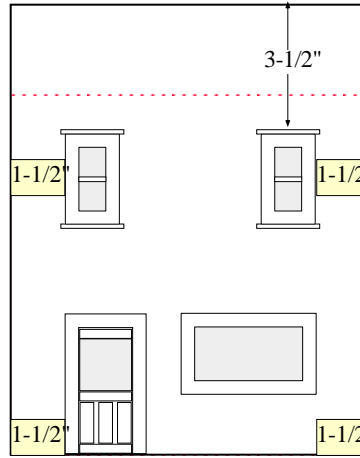

**F2**

Shown: Window # 1 up  
and Window # 5 down  
Can Use # 4 either place

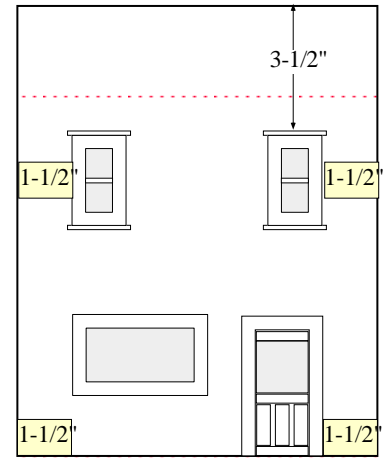

**F3**

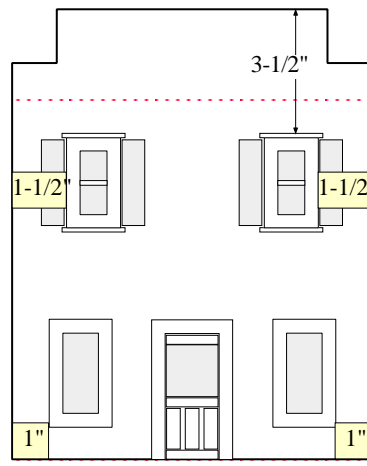

**F4**

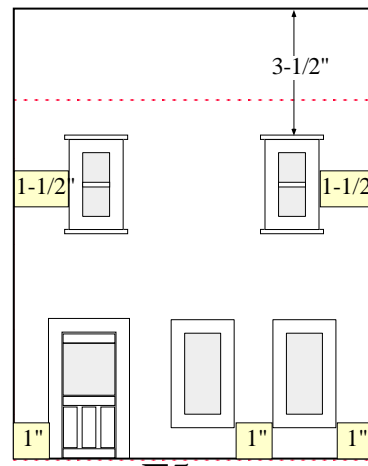

**F5**

Shown: Window # 1 up  
and Window # 4 down  
Can Use either window both places

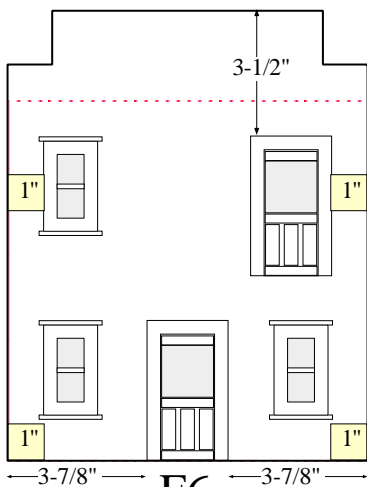

**F6**

Shown: Window # 1  
Can Use Window # 4

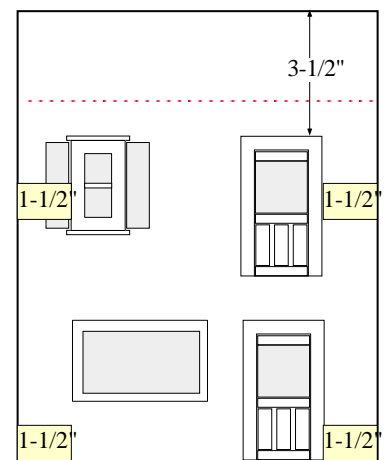

**F7**

Shown: Window # 1 up  
and Window # 5 down  
Can Use Window # 4 both places

**Side  
Walls**

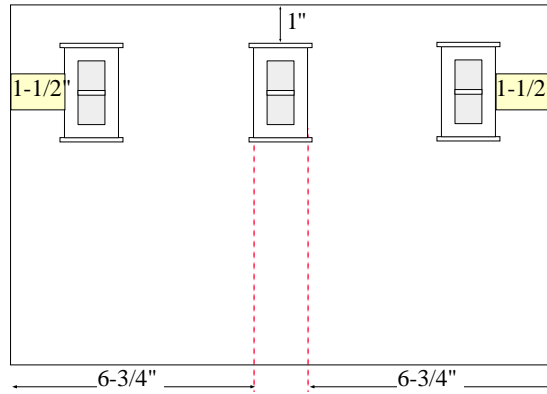

**S1**

Shown: Window # 1  
Can Use # 4

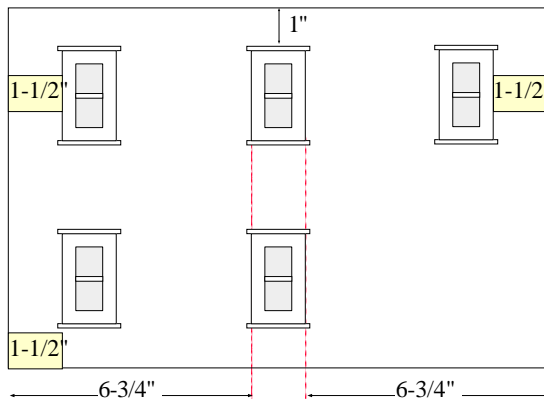

**S2**

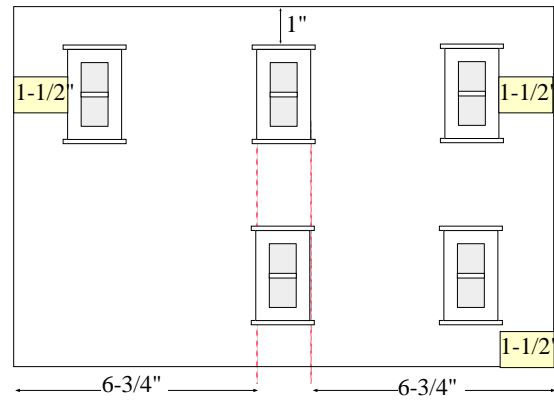

**S3**

Shown: Window # 1  
Can Use # 4

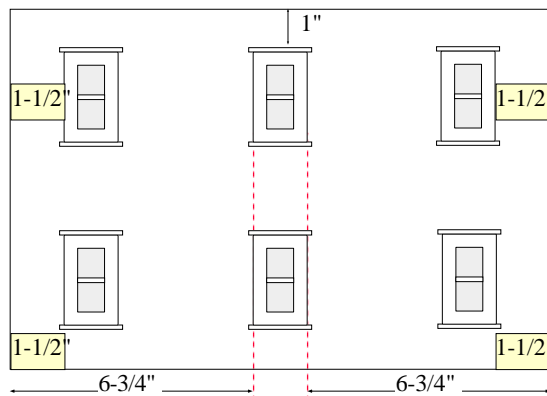

**S4**

Shown: Window # 1  
Can Use # 4

Side Walls

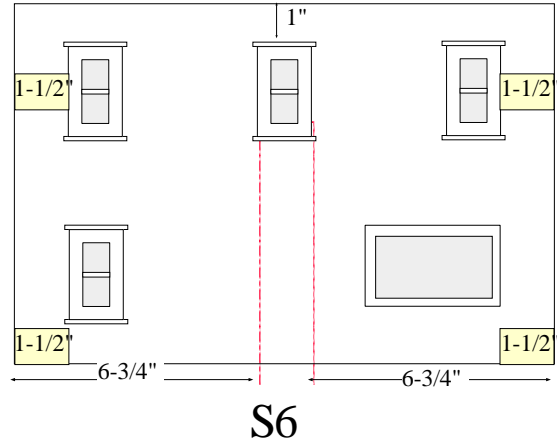
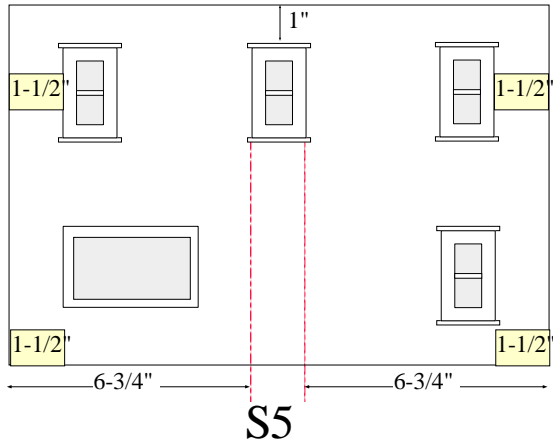

Shown: Window # 1  
Can Use # 4

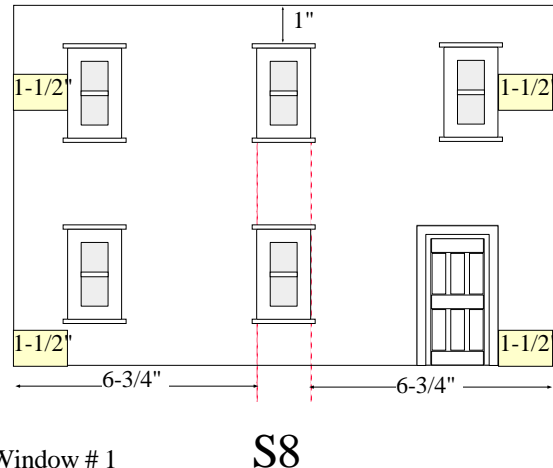
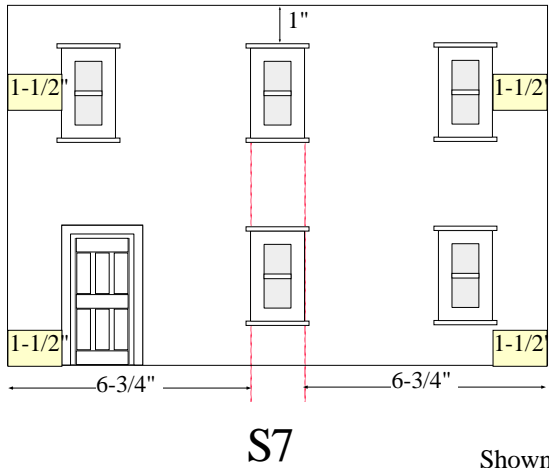

Shown: Window # 1  
Can Use # 4

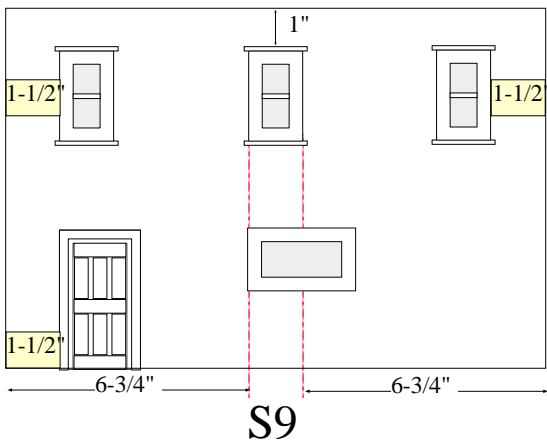

Shown: Window # 1 up and #4 down  
Can Use # 4 either place  
or # 5 Down if larger window desired

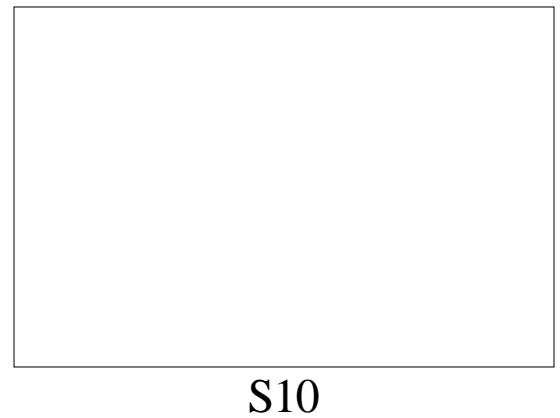

Use blank wall if you want  
to place against another building

**Back Walls**

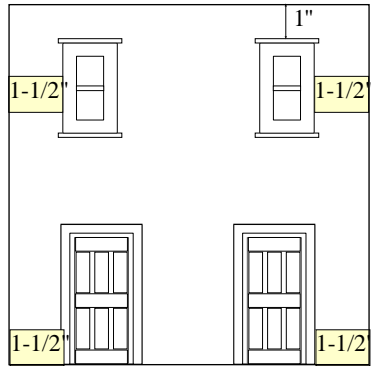

**B1**

Shown: Window # 1  
Can Use # 4

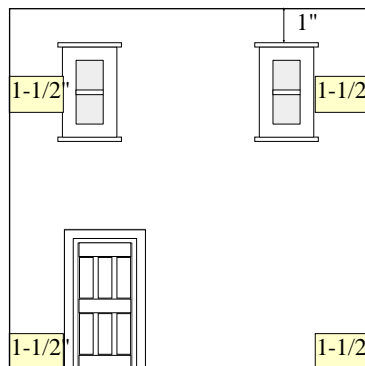

**B2**

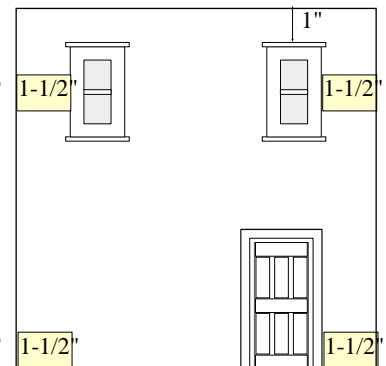

**B3**

Shown: Window # 1  
Can Use # 4

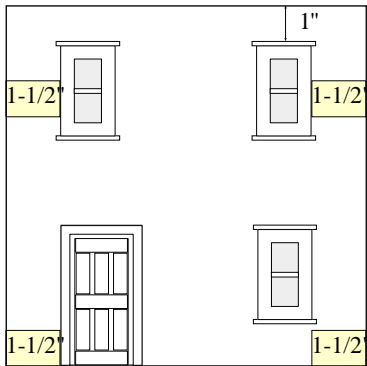

**B4**

Shown: Window # 1  
Can Use # 4

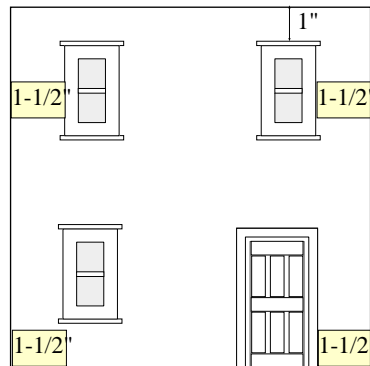

**B5**

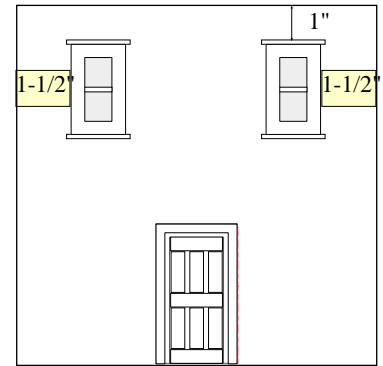

**B6**

Shown: Window # 1  
Can Use # 4

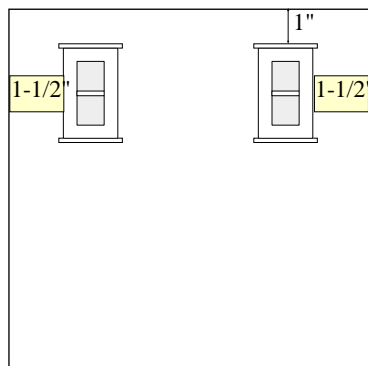

**B7**

Shown: Window # 1  
Can Use # 4

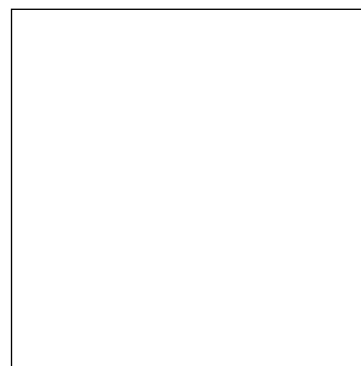

**B8**

Use blank wall if you want  
to place against another building

Can be used with any style  
one story or multi-story Building  
which has a flat roof  
or a flat roof false front

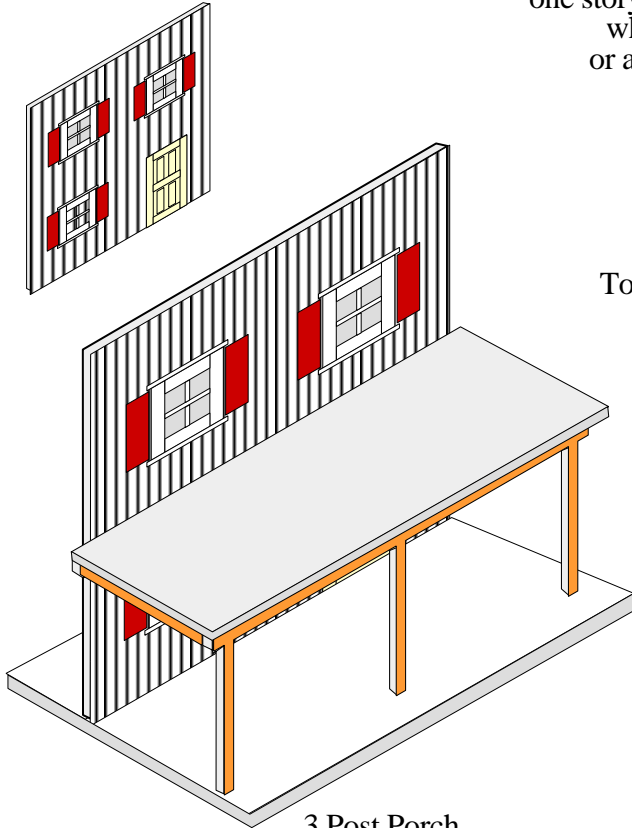

3 Post Porch  
for use with door  
off-centered.

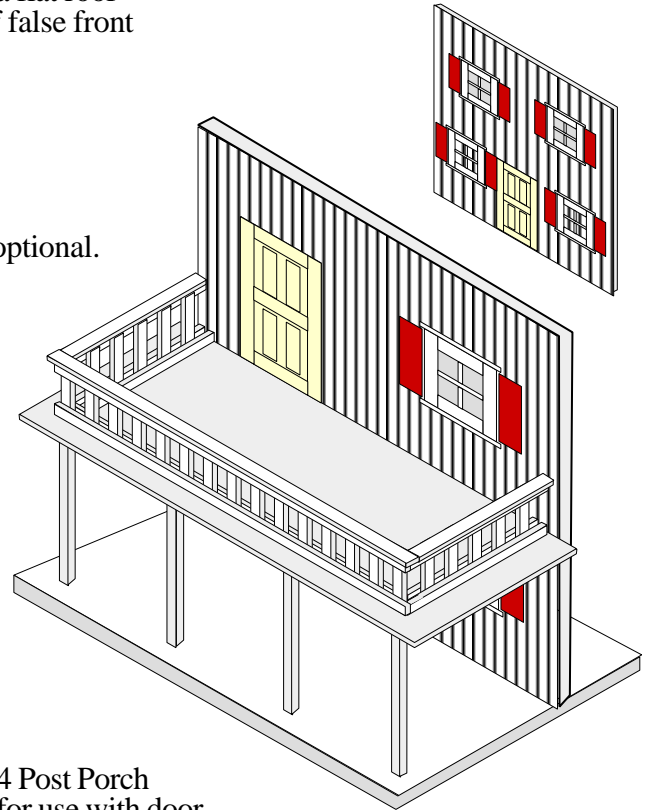

4 Post Porch  
for use with door  
centered.

Top rail is optional.

Patterns

Cut roof from  
1/4" Plywood

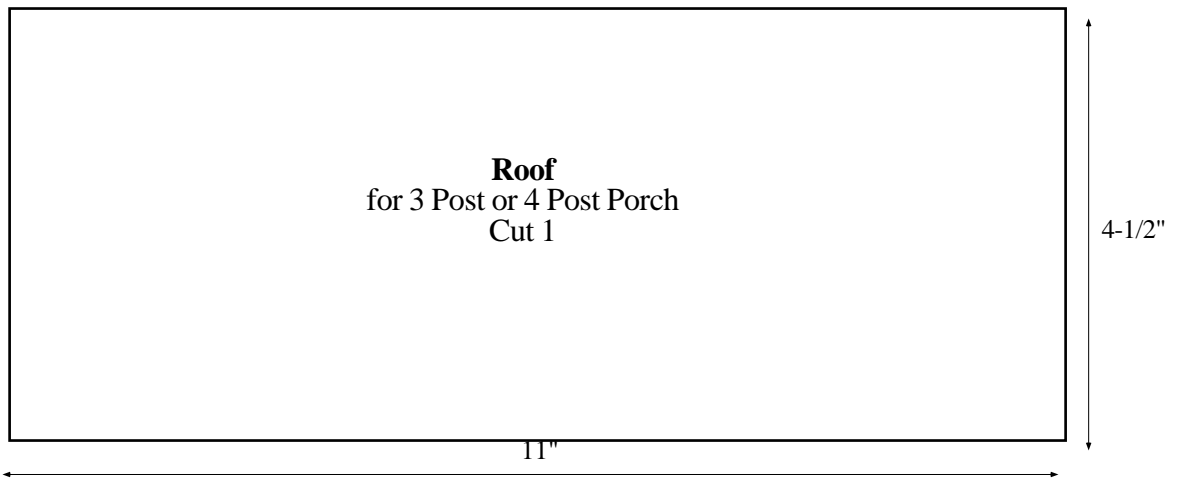

Cut Back and Sides  
from 1/4" Plywood  
OR  
Option - See Page 17  
Cut Back and Sides  
from 1/4" x 1/2" Hardwood Strips



**Sides**  
for 3 Post or 4 Post Porch  
1/2" High x 3-1/2" Long  
Cut 2

**Back**  
for 3 Post or 4 Post Porch  
1/2" High x 10" Long  
Cut 1



Cut Fronts with posts  
from 1/4" Plywood  
Or  
See Option Below

**3 Post Front  
Cut 1**

Use with  
Door to the side

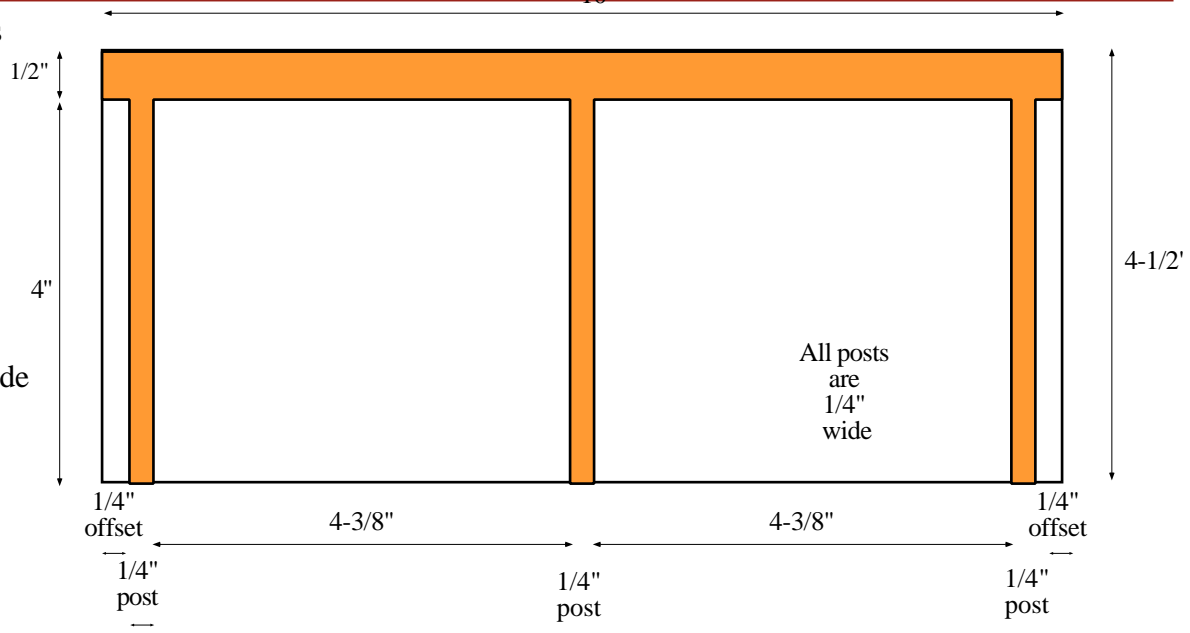

**4 Post Front  
Cut 1**

Use with  
Door Centered

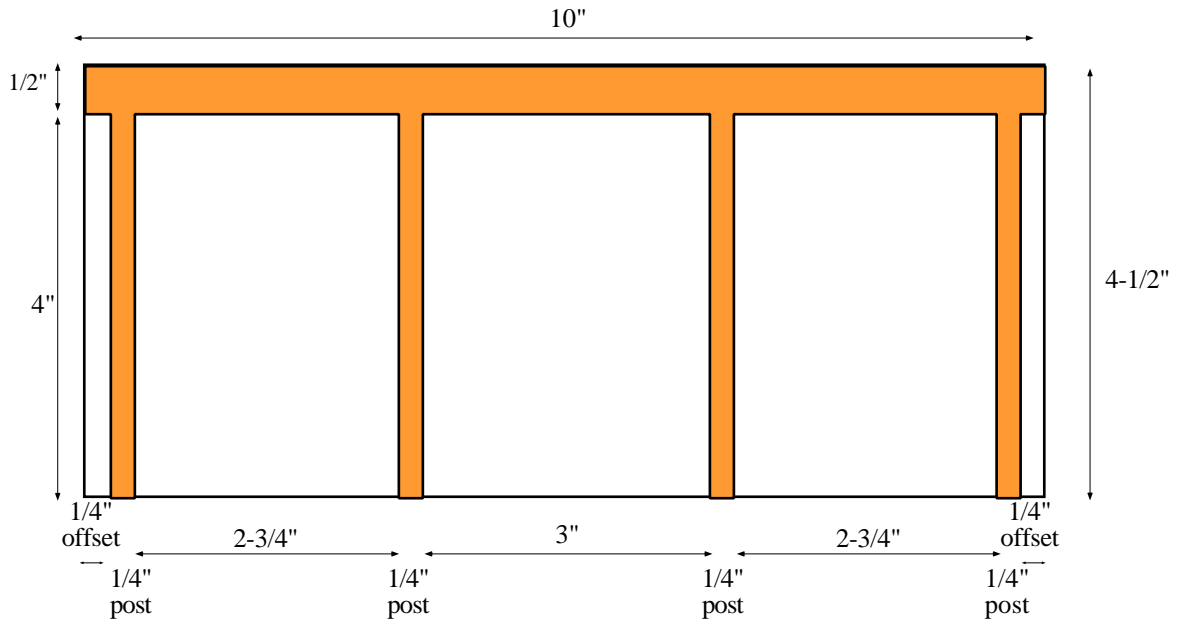

**Option: Cut Back, Front and Sides (plus added channel  
for posts) from 1/4" x 1/2" Hardwood Strips.  
Cut posts from 1/4" Square Strips**



Front & Back 1/4" x 1/2" x 10"  
Cut 2



Channel for Posts 1/4" x 1/2" x 9-1/2"  
Cut 1



Sides 1/4" x 1/2" x 3-1/2"  
Cut 2

Posts 1/4" x 1/4" square x 4-1/2"  
Cut 3 or 4

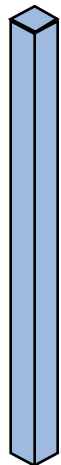

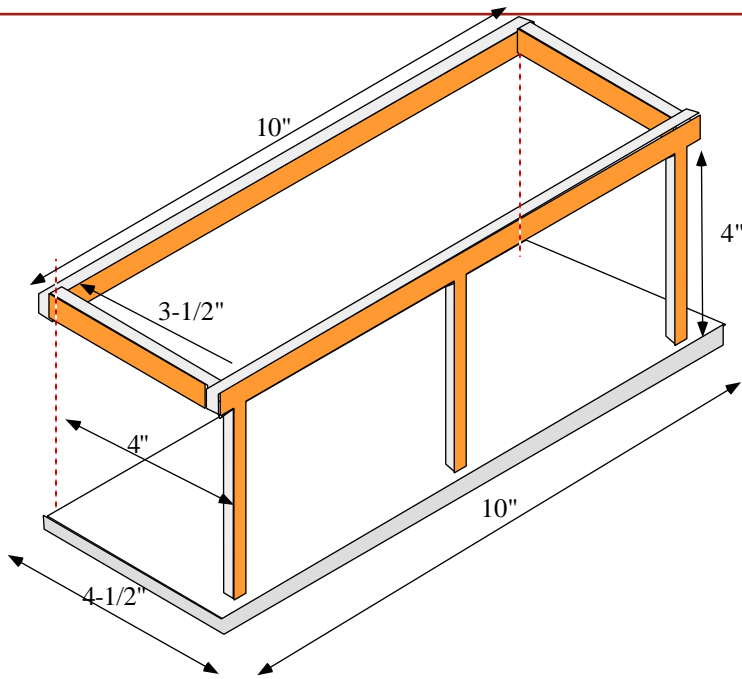

**A**  
Note the Sides  
are assembled on the inside  
of the Front and Back.  
Glue and nail porch as shown.

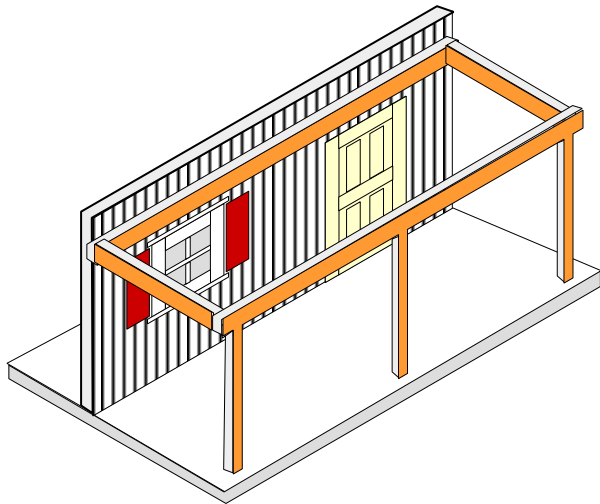
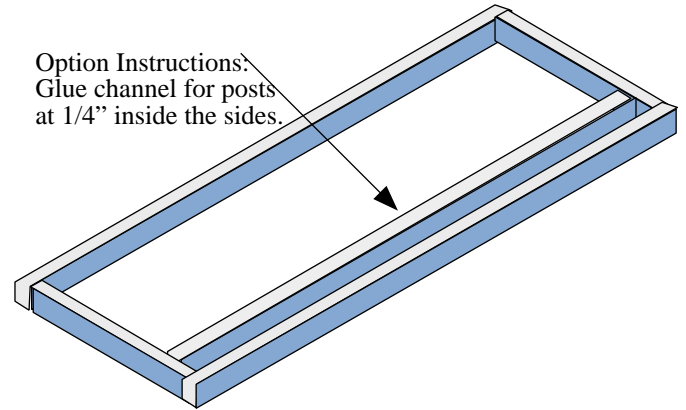

**B**  
Using your pilot holes on  
the front wall, glue and  
screw the porch frame  
from the inside of the  
wall.

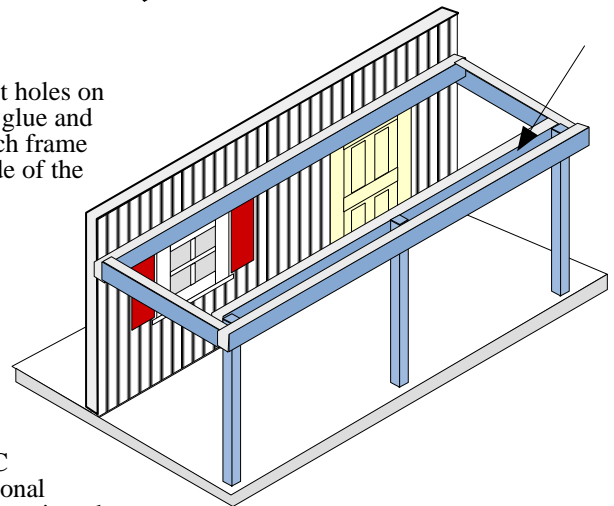

**C**  
Optional  
Insert the posts into the  
channel and glue in place.

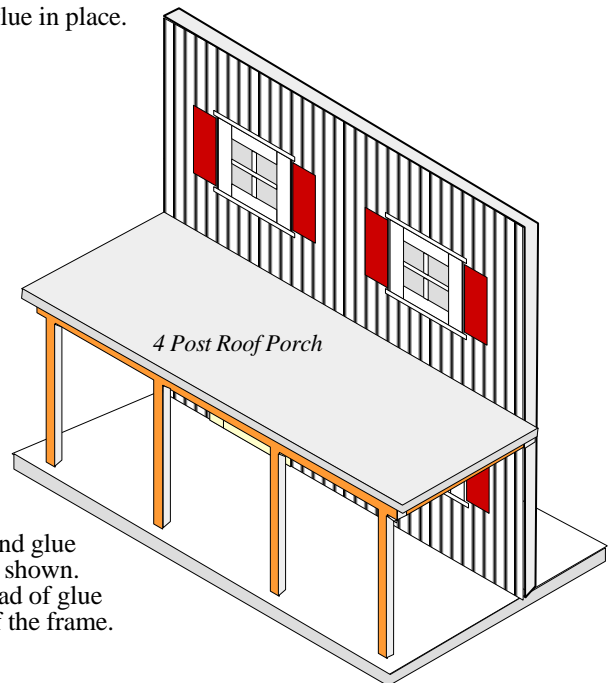
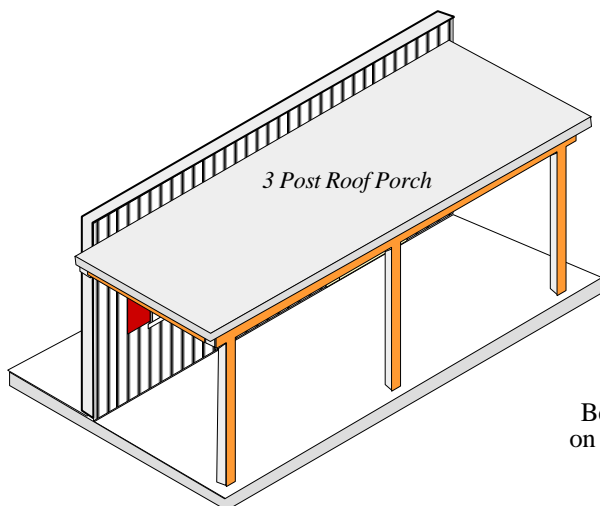

**D**  
Carefully center and glue  
roof onto porch as shown.  
Be sure and run a bead of glue  
on all exposed tops of the frame.

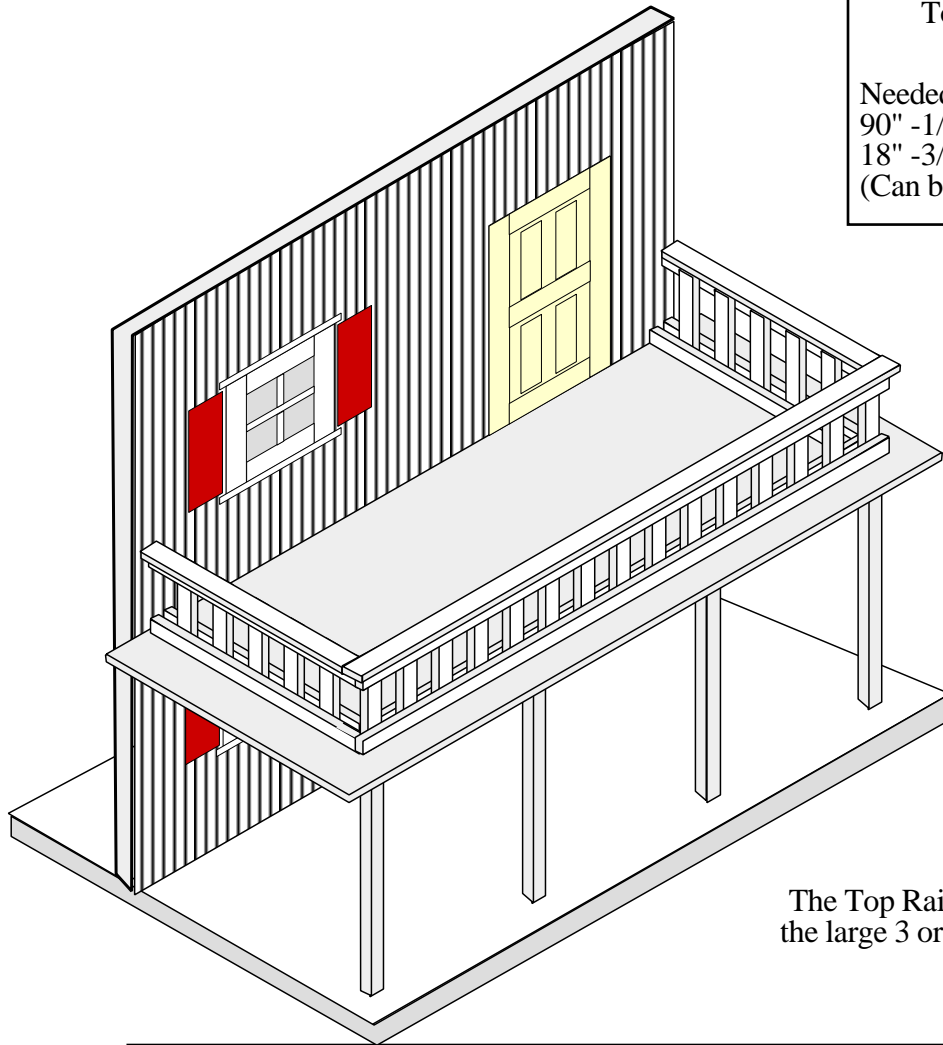

Top Rail is made from 1/8" thick Plywood or Hardwood

Needed:  
90" -1/4" Strips  
18" -3/8" Strips  
(Can be cut from 4" x 10" piece of wood)

The Top Rail can be added to the large 3 or 4 post porch roof

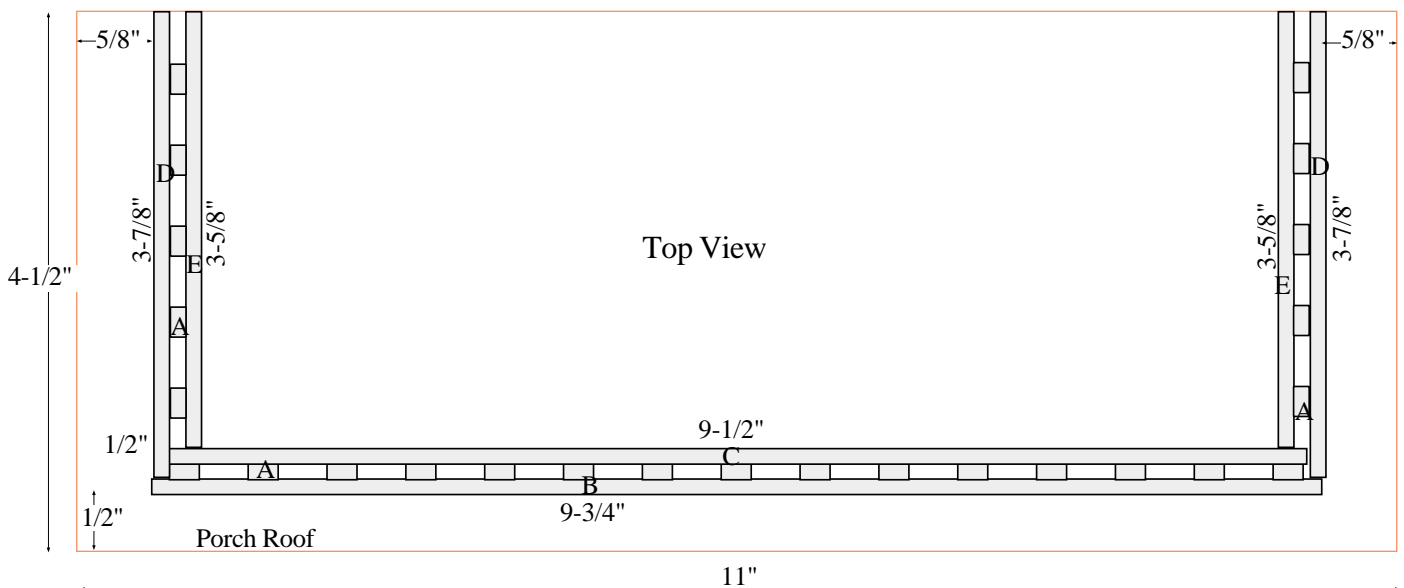
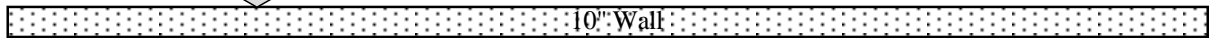

The Parts

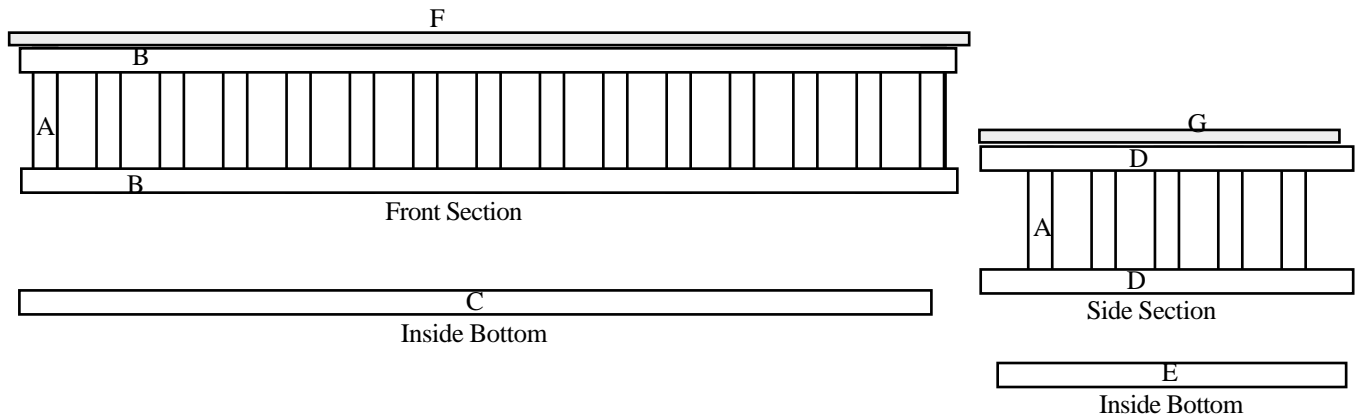

**The Patterns**  
All Wood is 1/8" Thick

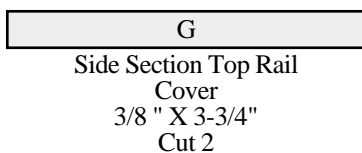
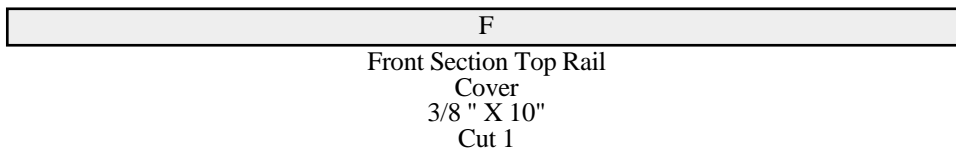
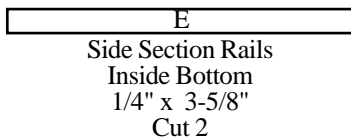
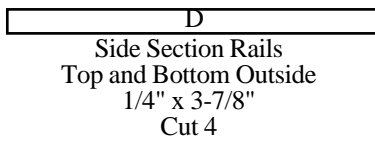
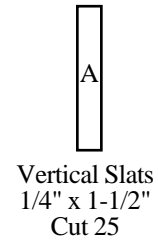
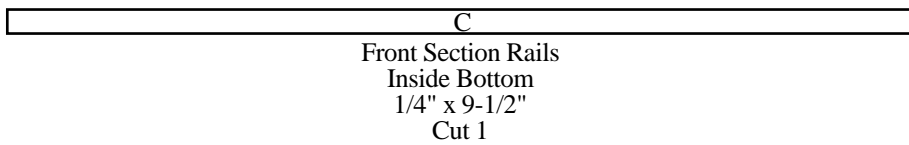
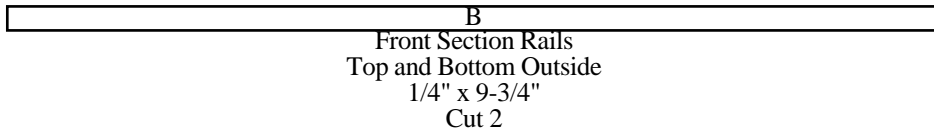

1. Cut out all Parts

2. Front Rail (Make 1)

Lay (B) Side Section Rails parallel on a flat surface 1-1/2" apart. Use the Spacing Guide on Page 9 and attach the vertical rails.

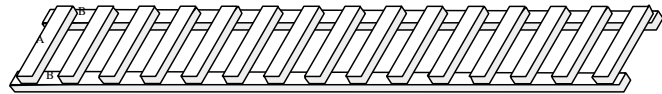

3. Center (C) Inside Bottom on the bottom and glue in place. Bottom inside rail will be 1/8" shorter on each end.

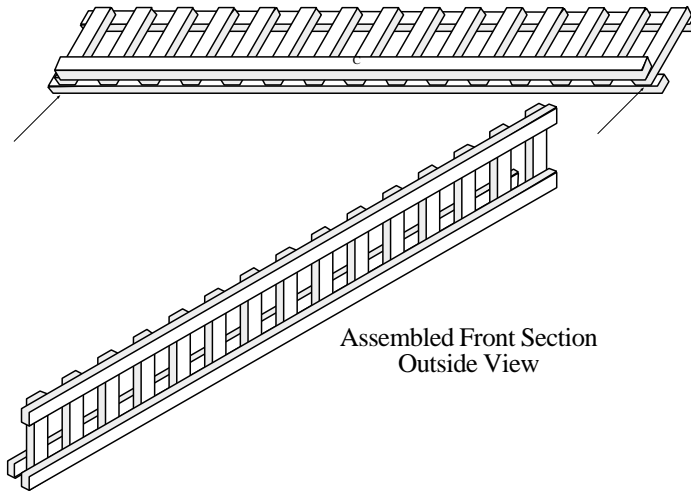

Side Rails (Make 2)

4. Lay (D) Side Section Rails parallel on a flat surface 1-1/2" apart. Use the Spacing Guide on Page 9 and attach the vertical rails.

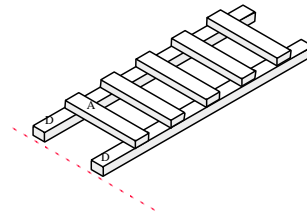

5. LH Side Rail  
Line up (E) Inside Bottom above the right end on the bottom and glue in place. Inside bottom rail will be 1/4" shorter on the opposite end.

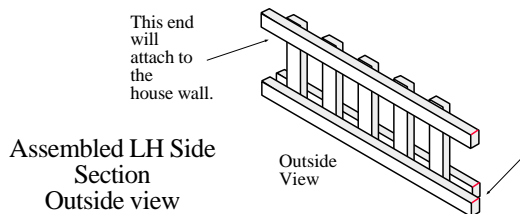
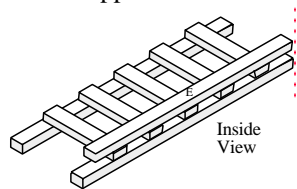

6. RH Side Rail  
Line up (E) Inside Bottom above the left end on the bottom and glue in place. Inside bottom rail will be 1/4" shorter on the opposite end.

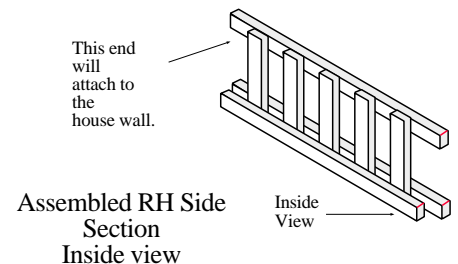
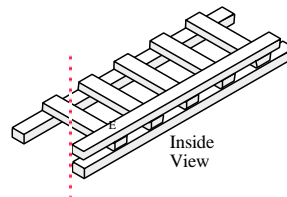

7. Lay the Top Rail Parts (F & G) on a Flat Surface, forming a 90° angle. Glue together as shown. Clamp in place until dry.

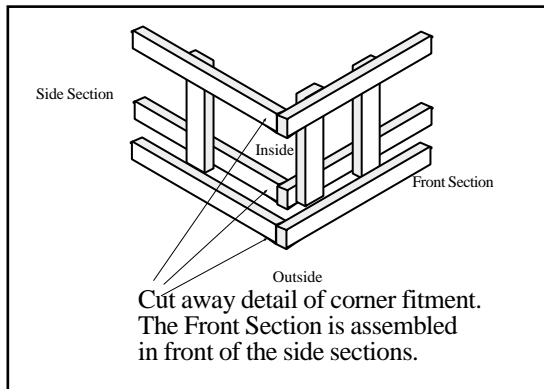
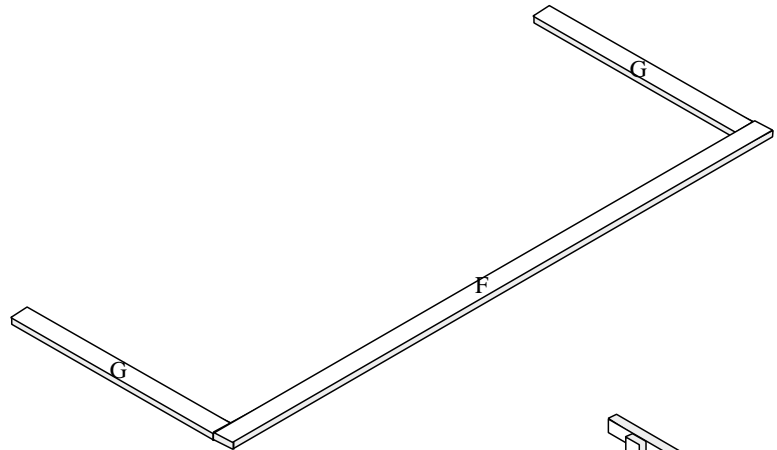

8. Glue the fence sections together.

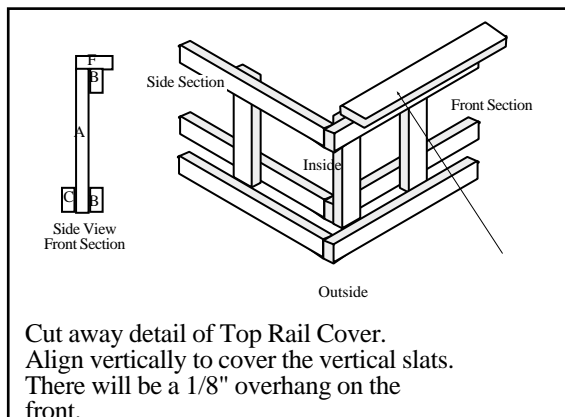
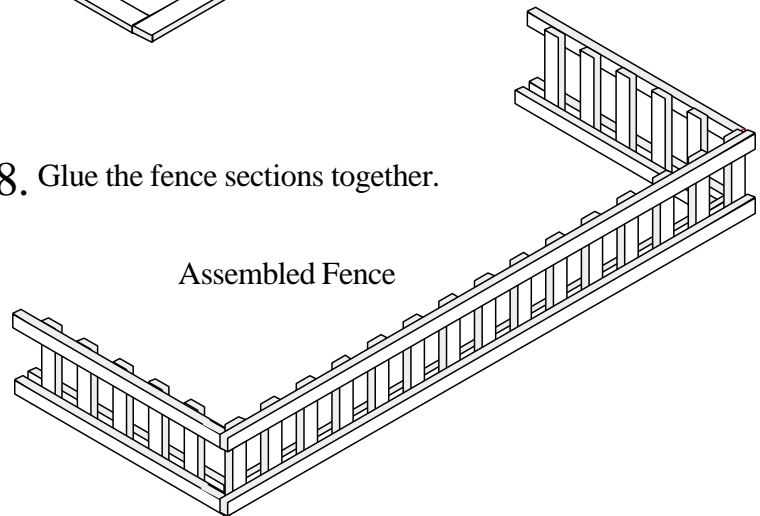

9. Glue the Top Rail to assembled Fence

Fence can then be centered and glued to the porch roof.

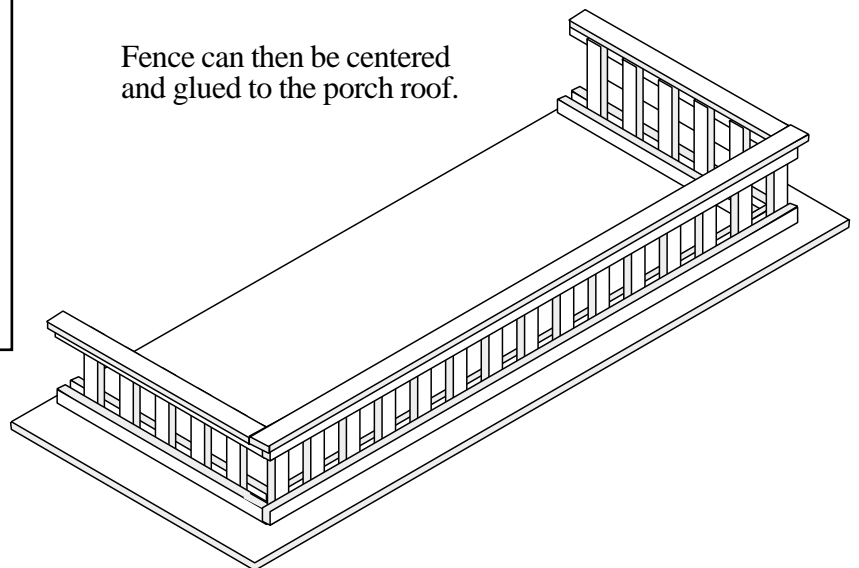

**Section Spacing Guides  
are Actual Size**

(Spaces between slats  
are approximately 13/32")

**To Use the Guides**

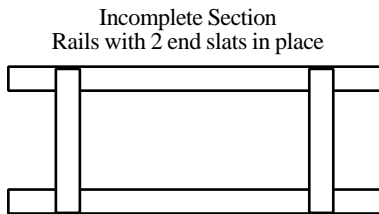
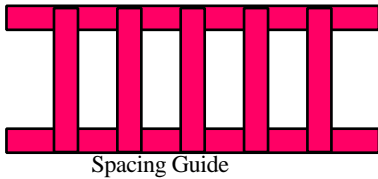

1. Measure according to instructions  
and glue the two end  
vertical slats to the rails.

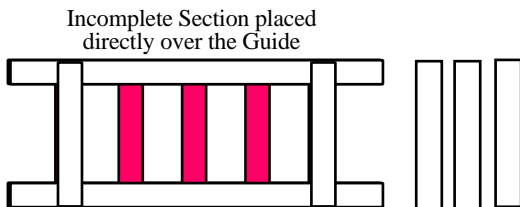

2. Lay the Incomplete Section  
directly on top of the  
appropriate guide

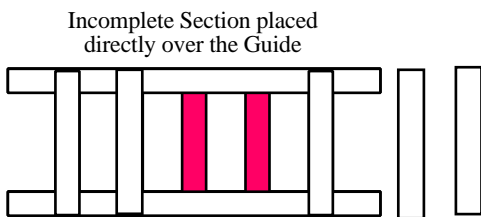

3. Place and glue all the  
remaining  
slats directly over the  
corresponding slats  
on the guide.

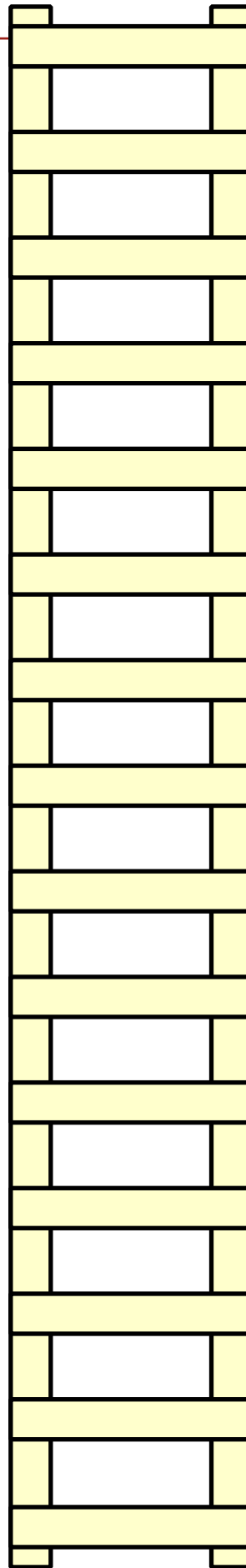

Front Section Guide for  
Vertical Slat Placement

Begin 1/8" from the ends.

Side Section Guide for  
Vertical Slat Placement

Begin 1/2" from the ends.

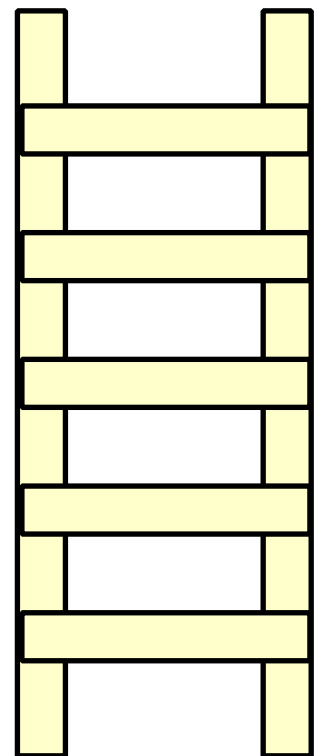

**Cut from 1/4" Plywood**

**Front Wall (Choose between straight top or stepped top)**

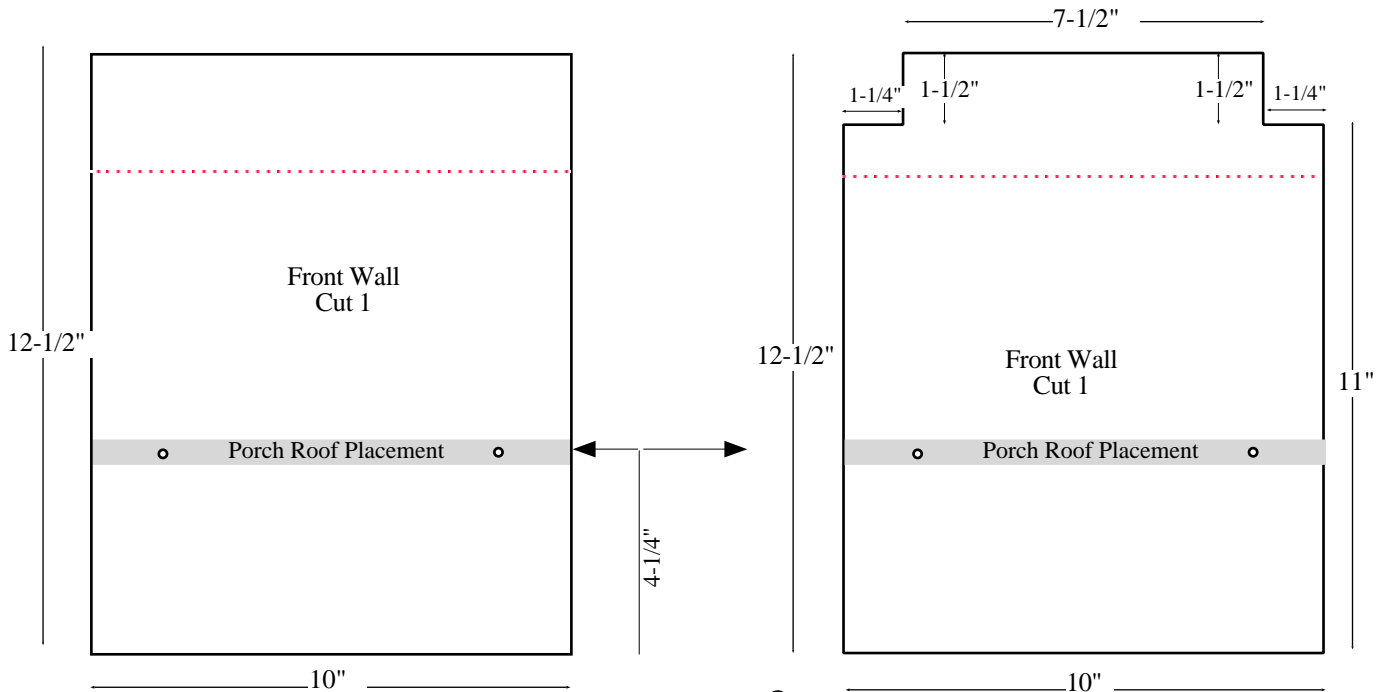

Front Walls Only

For Porch Roof Attachment  
Drill 2 small pilot holes through the front  
at 4-1/4" from floor line and 1-1/2" from  
each side.



**Side Walls**

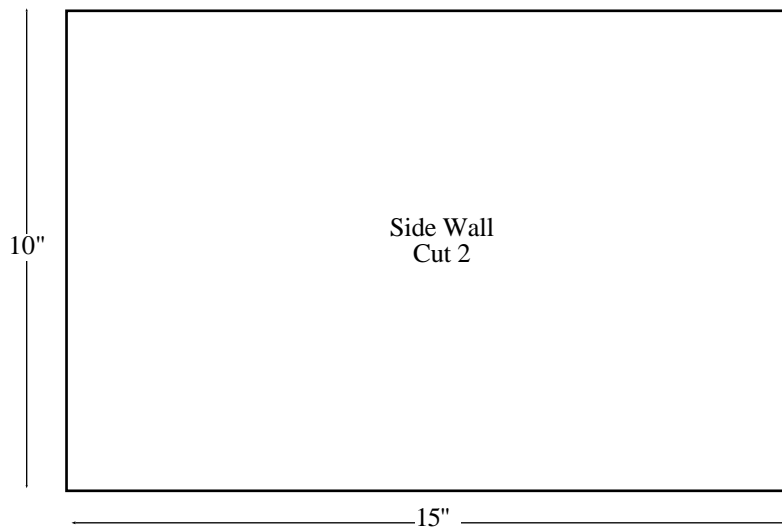

**Back Walls**

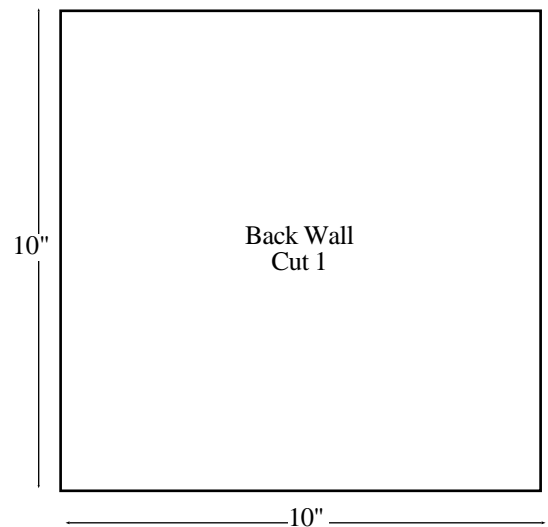



**Cut from 1/4" Plywood**

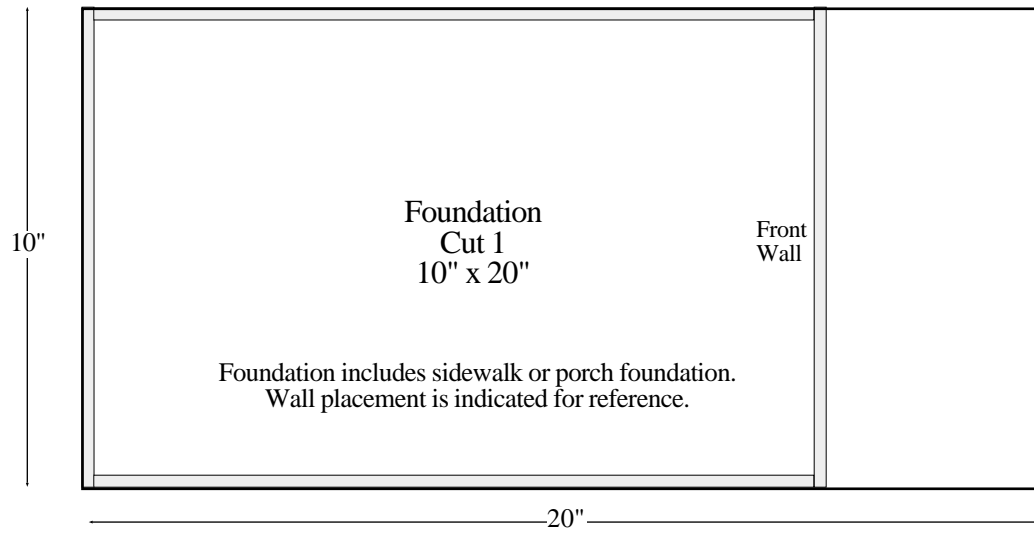
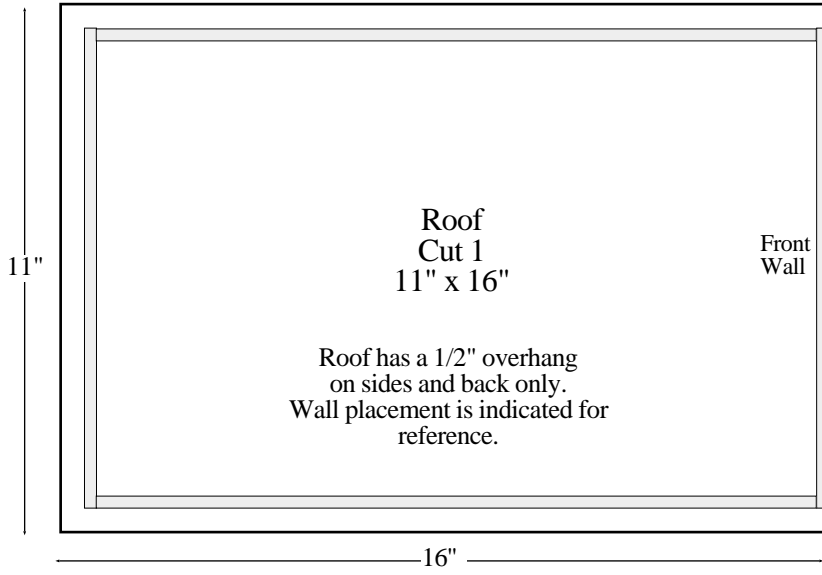

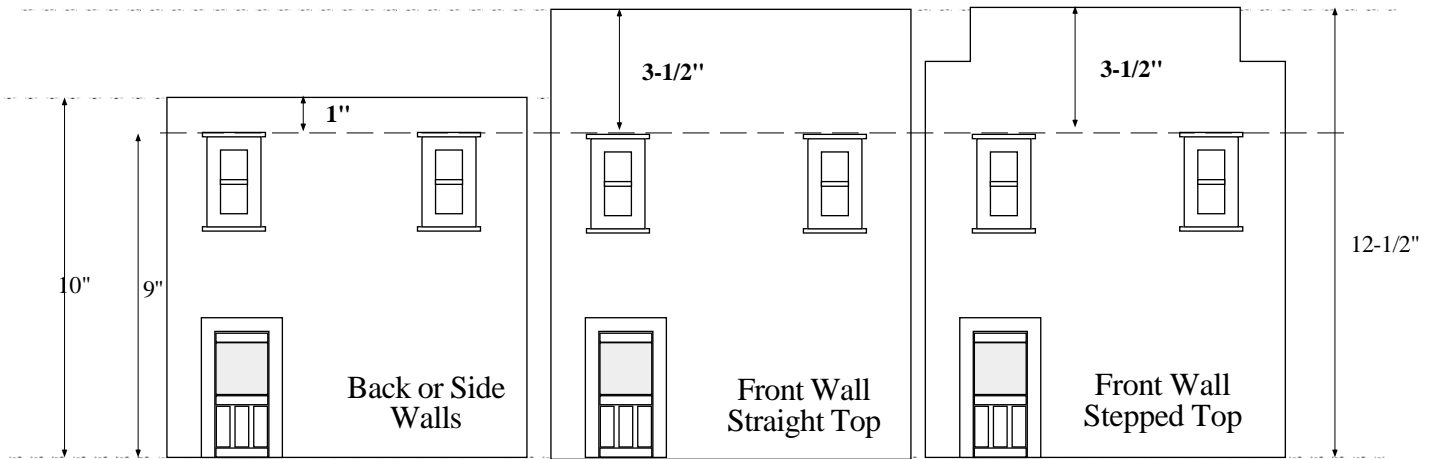
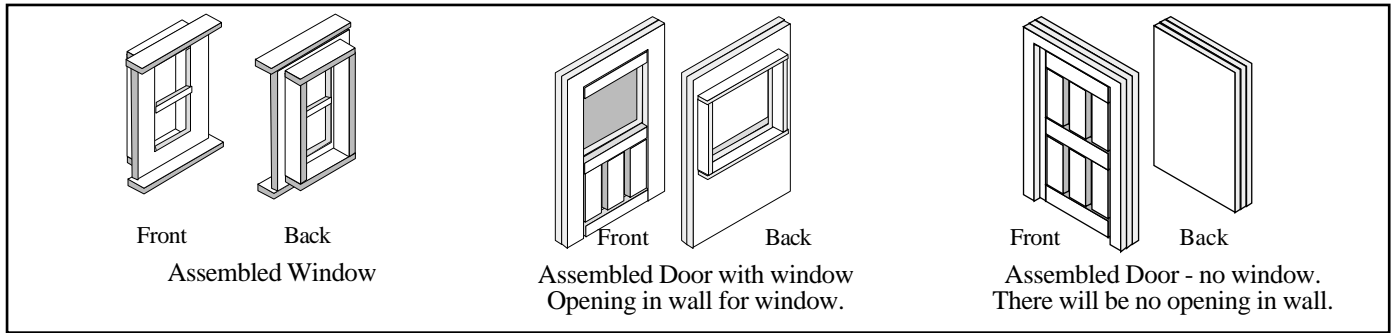

Note: The Front Walls of the Town Buildings are 2-1/2" Taller than the Sides and Back.

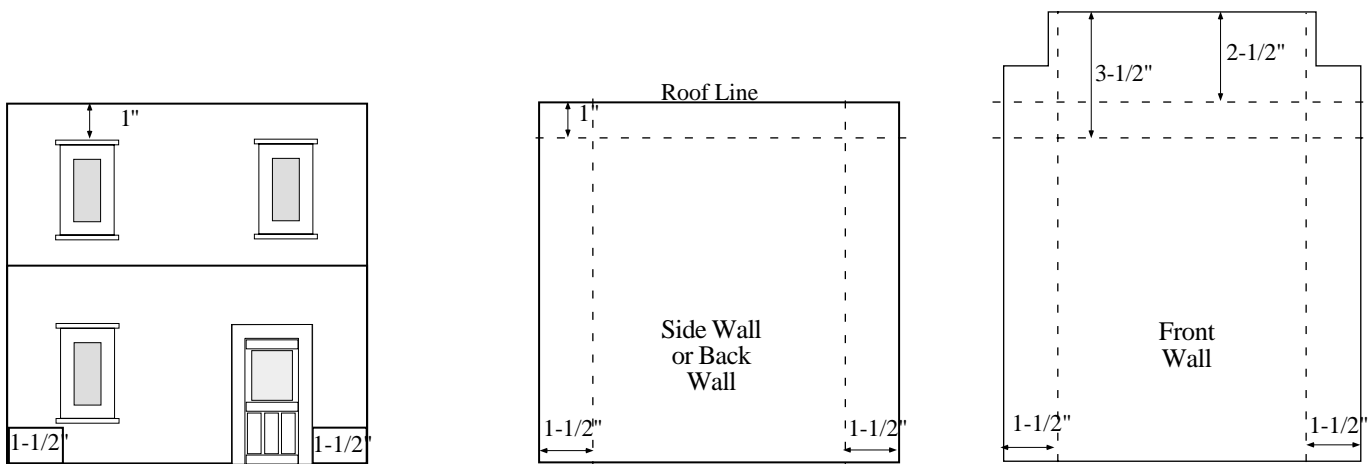

1. Decide where you want to place door and windows on the cut-out wall.  
The openings must be inside of the building frame behind the wall.

3. Side or Back Wall:  
•Draw horizontal line 1" from the top of the wall (roof line).

2. All Walls:  
•With pencil and ruler, lightly draw vertical guide lines on the wall sides.  
Minimum guide is 1" for frame clearance.

4. Front Wall:  
•Draw horizontal line 3-1/2" from the top of the wall.  
•Draw second horizontal line 2-1/2" from the top of the wall (this is the roofline for the front wall).

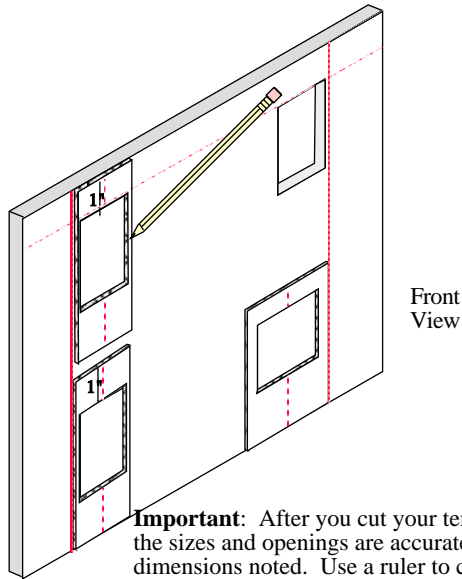

**Important:** After you cut your templates, check that the sizes and openings are accurate according to dimensions noted. Use a ruler to check. *You can take a finished window and make sure that it physically fits into the template opening.*

**Template for Window Opening in Wall**

5. Using your side guide lines, place the template as follows.

**Ground floor:**

Bottom of template will be on bottom of wall

**2nd floor - Side wall or Back Wall -**

Top of template will be on top of wall

**Front Wall -**

Top of template will be on the 2-1/2" Guide Line (roof line)

Using template and pencil, mark the window opening on the building. Cut out opening on building. The opening is now ready for the finished window.

Door should be painted or stained before you actually insert and secure it into the building.

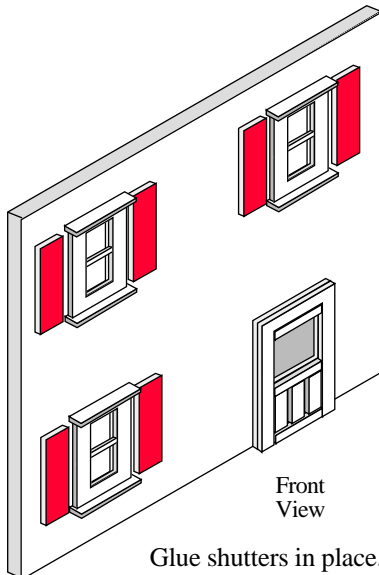

6. Before gluing windows, check to see that they will easily fit the wall openings. Trim openings if necessary.

Place some wood glue on the flat backs of the finished window and door with window. (around the frame) This will adhere to the front of the wall.

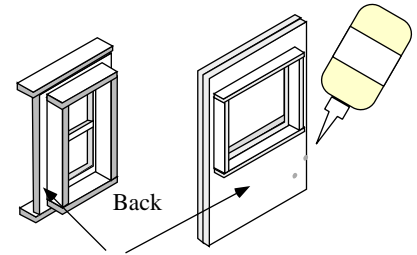

**Install doors and windows after the walls are assembled but before adding the roof. (page 31)**

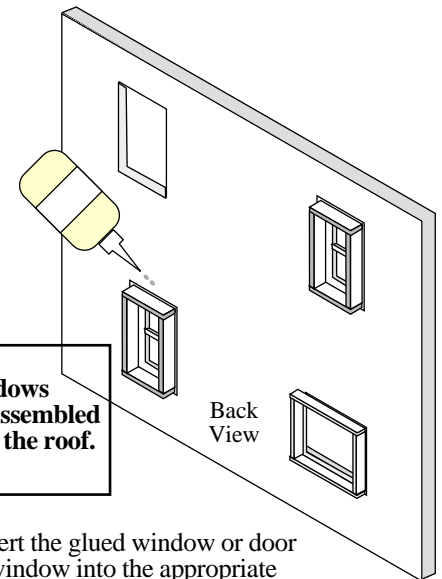

7. Insert the glued window or door with window into the appropriate wall opening. Look at the front side and using a level, make sure the window is straight. Run a bead of wood glue around the window brace. Allow the glue to dry.

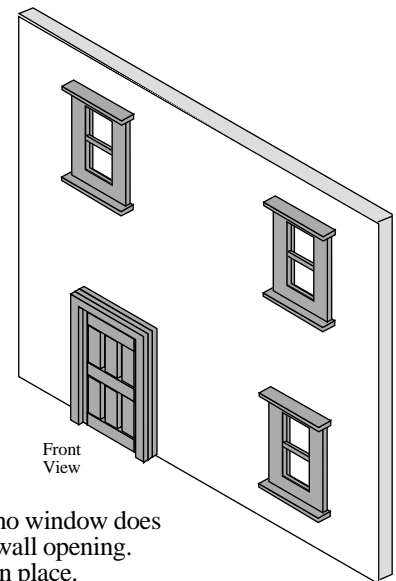

Door with no window does not have a wall opening. Glue door in place.

1. Cut out all pieces needed to assemble your building

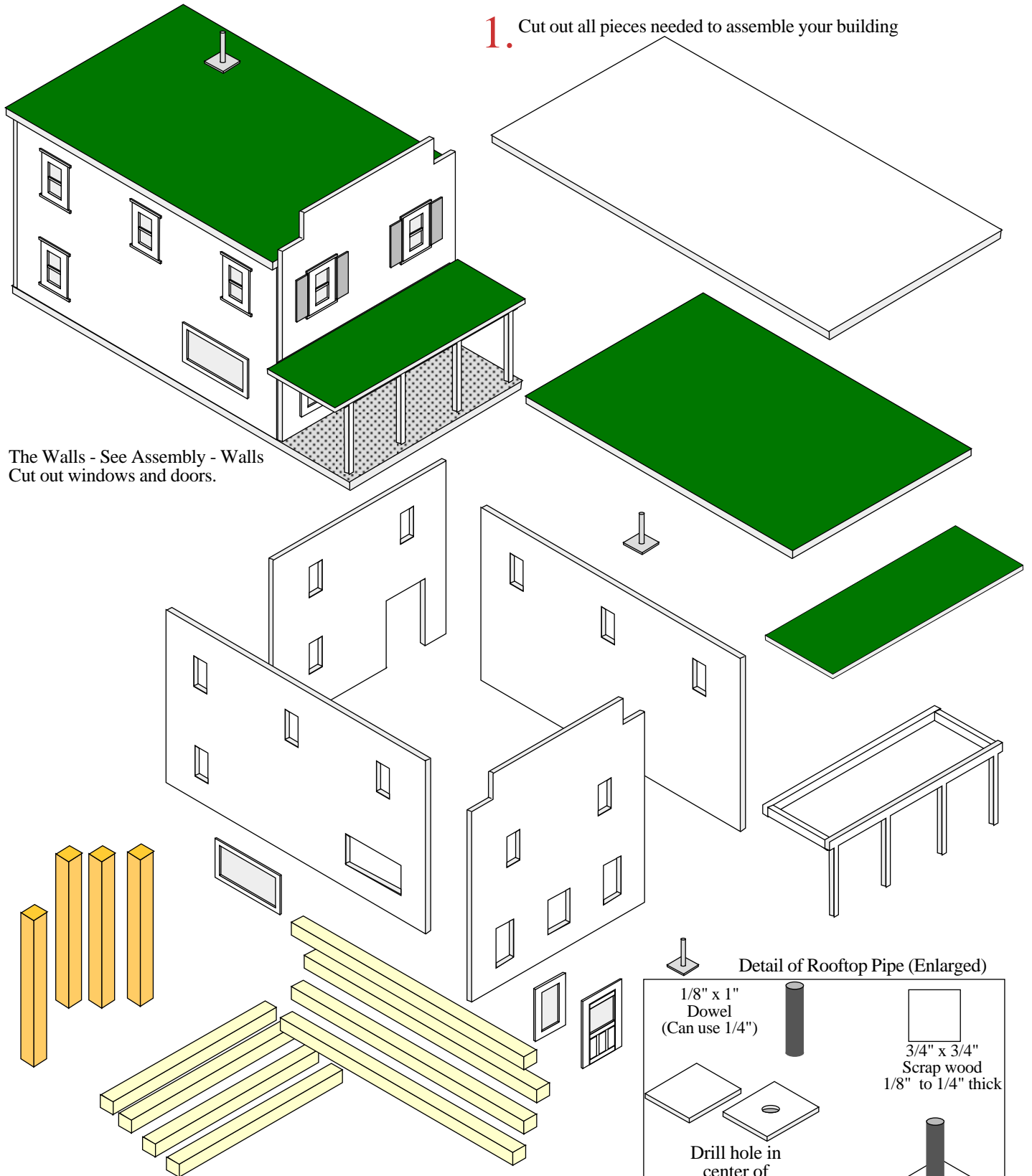

The Walls - See Assembly - Walls  
Cut out windows and doors.

See the Framing  
Instructions to determine size and  
number of braces you will need.

↓ Detail of Rooftop Pipe (Enlarged)

1/8" x 1" Dowel  
(Can use 1/4")

3/4" x 3/4" Scrap wood  
1/8" to 1/4" thick

Drill hole in center of pipe base  
(1/8" for 1/8" dowel)

Glue dowel in hole.

Paint black and attach to roof

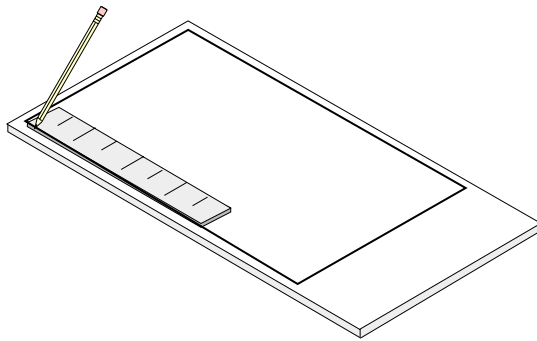

**2.** Bottom Frame (1" Furring Strips - nominally 3/4" square)

- Using the **Diagram for Frame Assembly**, measure and mark your foundation.

The shorter braces are for the front and back of the building.  
Side wall braces are assembled inside the front and back wall braces.

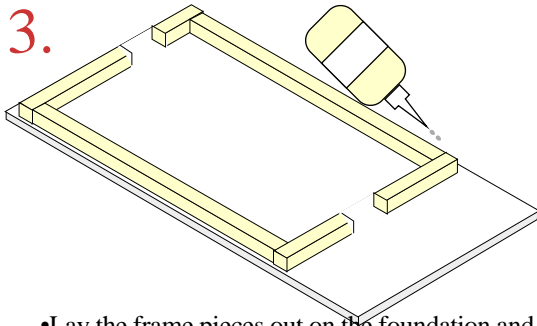
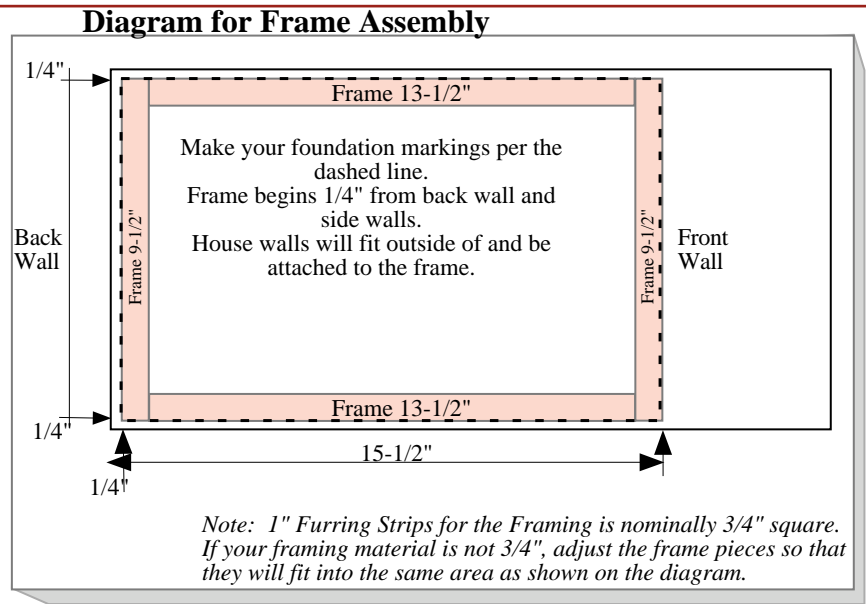

- Lay the frame pieces out on the foundation and check that they fit inside the drawn lines.
- If you are using opening doors, cut out appropriate spaces wherever you wish to place the doors. **For non-opening doors, do not cut openings.**
- Glue frame in place, one piece at a time, Immediately go to step 3A.

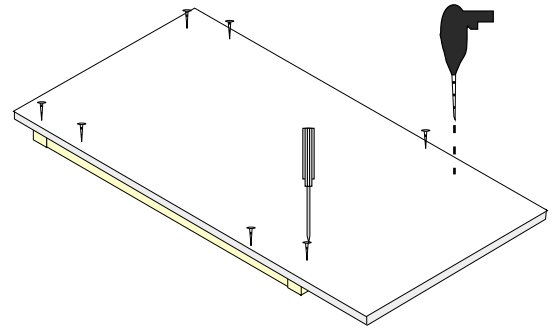

To strengthen the assembly. Before the glue is completely dry, turn the foundation upside down. Drill pilot holes and insert small flat head wood screws (or nail) the frame from the bottom side. Just put a couple of screw into each frame section, avoiding any cutouts for doors, if applicable.

**4.** Top Frame (1" Furring Strips - if your furring strips are not 3/4" square and you had to adjust the bottom frame pieces, make the pieces for the top frame exactly the same lengths. Do not cut openings for doors.

- Lay the pieces out on a flat surface, using continuous pieces. The overall dimensions will be the same as the bottom frame.
- Glue and Nail or staple the bottom frame together, again maintaining corner angles.

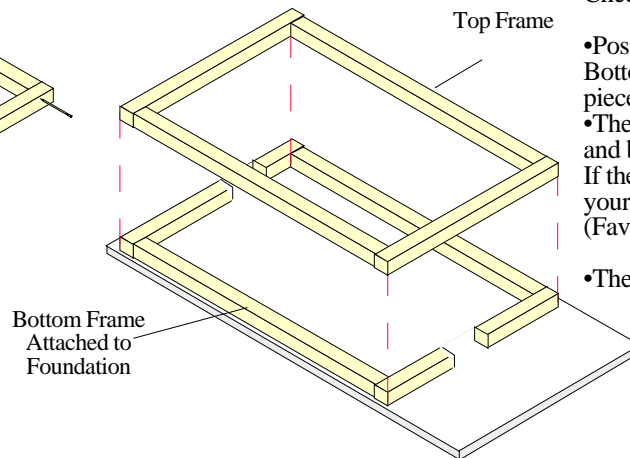
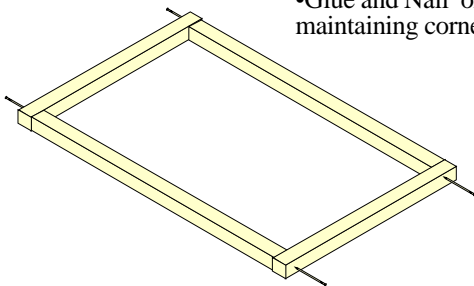

**Check Alignment of Horizontal Frames**

- Position the Top Frame over the Bottom Frame to ensure that the two pieces are in alignment.
- The two frames should line up vertically and be the same dimensions on all sides. If they don't line up, double check your work and make adjustments. (Favorite thing to do)
- Then lay the Top Frame aside.

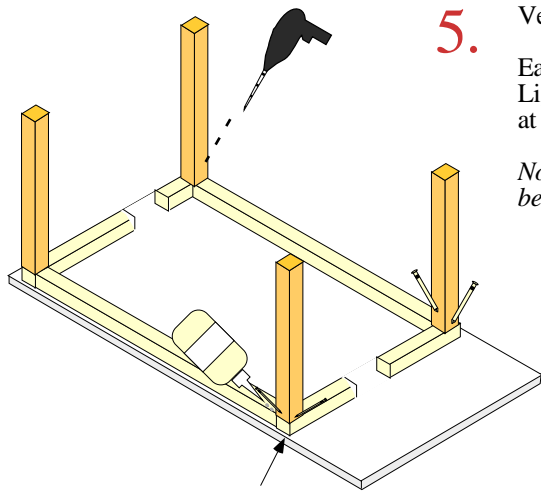

5. Vertical Studs

Each wall needs a vertical stud on each end. Lightly glue and nail or staple a vertical stud at each corner for the walls to be attached to.

*Note: Nailing the studs in place will be much easier if you begin with drilling a small pilot hole for the nail.*

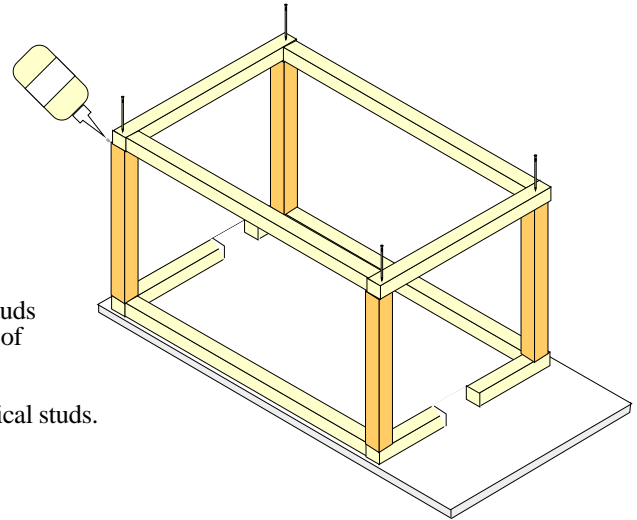

6. Lightly glue the tops of the vertical studs. Place the assembled top brace on top of the vertical studs, matching up with the bottom brace. Nail or staple the top brace to all vertical studs.

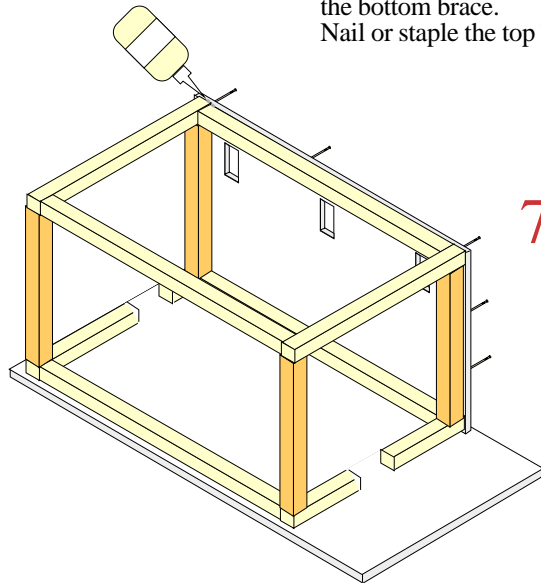

7. Start at one end of building. Glue and nail or staple walls in place to the frame. Work walls together in a clockwise or counterclockwise direction. Direction doesn't matter. Just fit the adjacent walls and keep going in the same direction.

8. Continue adding walls until all walls are in place. Always nail or staple into the frame. Check that each wall is sturdily attached and that there are no "floppy" walls.

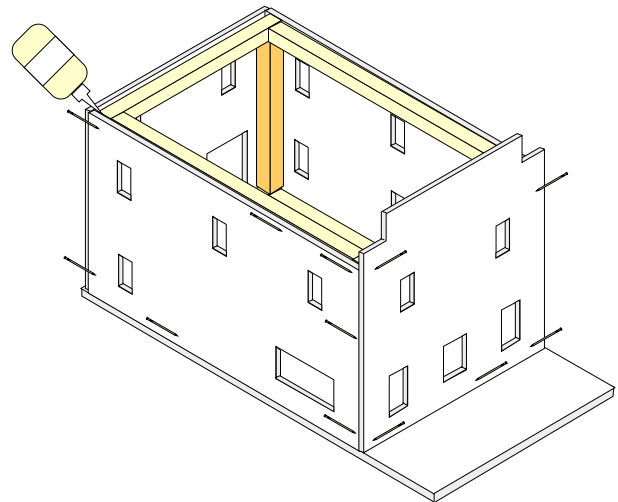



9.

Fill in nail holes with wood putty and paint the building before you add your doors and windows. If necessary, dings from installation can be touched up later.

Allow the paint to dry completely and install doors and windows according to wall assembly details on page 27.

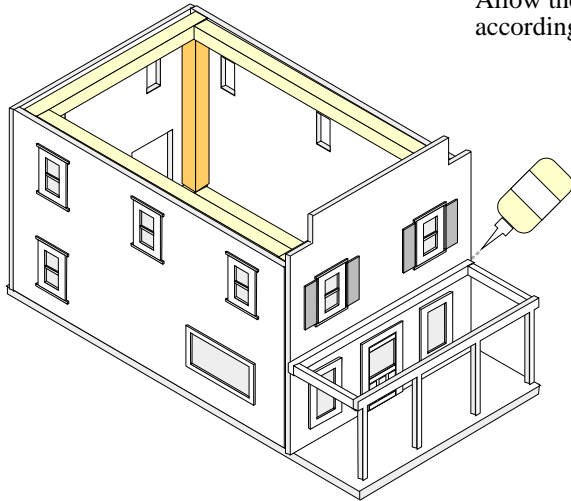

10.

Position and attach the porch frame to the house wall. Use glue and insert small wood screws through the pilot holes from the inside of the building. Be sure to secure the posts to the foundation. When dry, carefully center and attach the porch roof.

If you are adding a top rail assembly to the porch roof (page 19), it should be completely assembled, painted and sealed before it gluing to the roof.

**Note: If you are adding lights to your house, use screws to attach the roof. This will enable you to have future access to the wiring.**

11.

OR

Run a bead of glue around the exposed wood that the roof will sit on. Carefully center the main roof in place. Glue and nail or staple to the building, nailing into the frame.

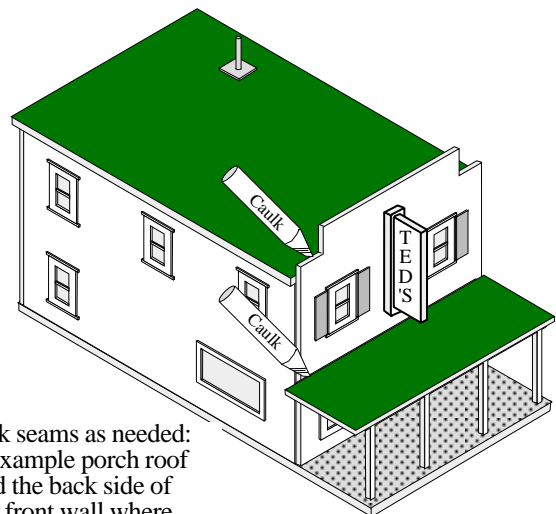

Caulk seams as needed: for example porch roof and the back side of the front wall where it joins the roof.

12.

Optional: Make a sign with the name of your choice of business. Glue the finished Rooftop pipe in place.

Building is ready to touch up and seal if necessary.