

Scaled and easy to read patterns and instructions  
for a Church made from wood.  
Compatible with Garden Scale Railroads  
and Garden Town Houses or Buildings

- Patterns include:
- Church building complete
  - Steeple
  - Stairs
  - Roof pipe

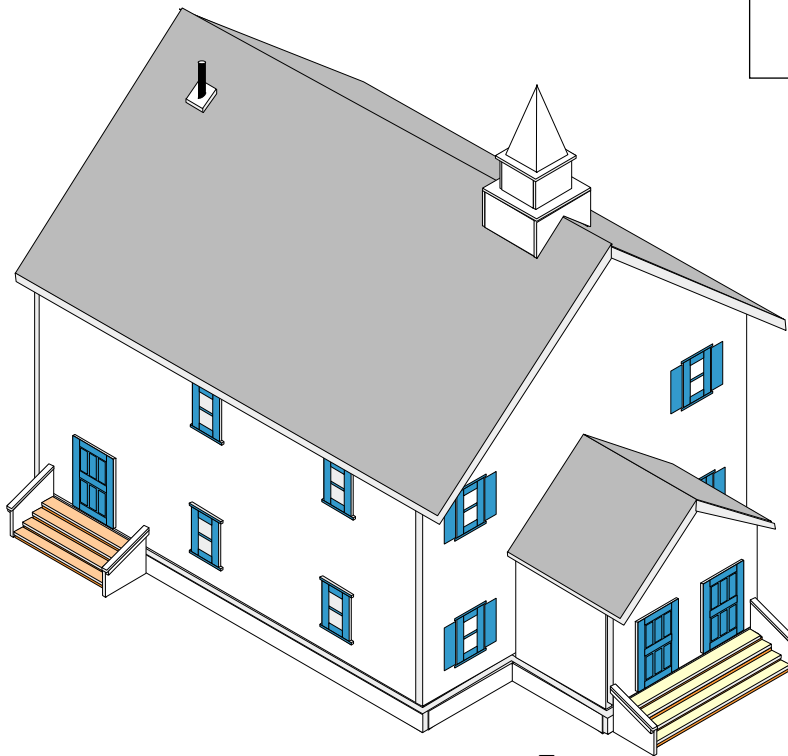

Front

Overall Dimensions  
Foundation: 18" x 26-3/4", including addition  
Walls: 12" high with 21" roof peak

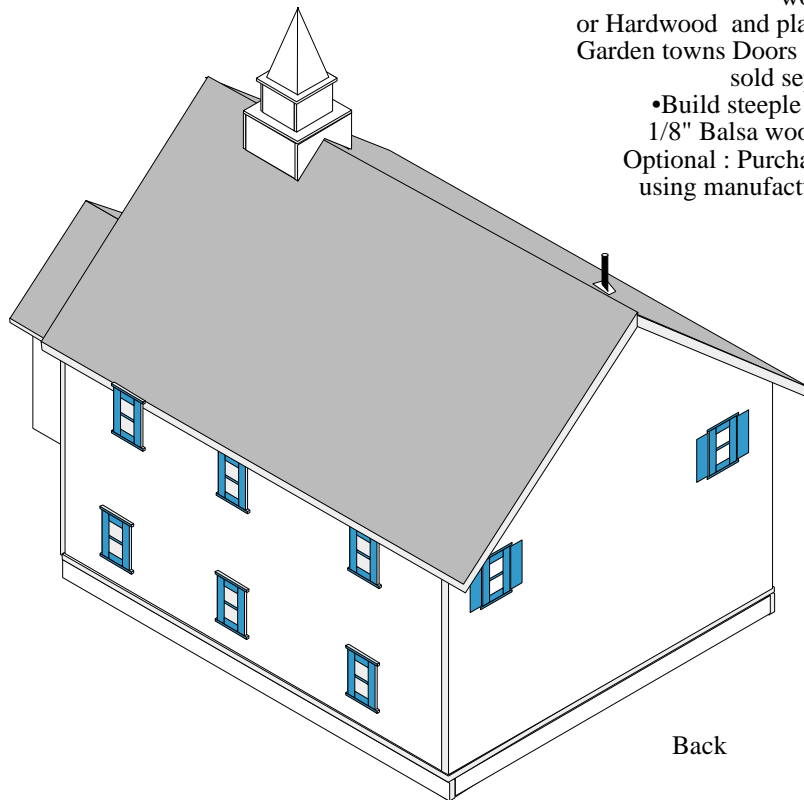

Back

- Build Church from 1/4" plywood
- Purchase doors and windows
- or
- Build doors and windows from 1/8" Balsa wood
- or Hardwood and plastic glazing for panes. Garden towns Doors and Windows patterns sold separately
- Build steeple and stairs from 1/8" Balsa wood or Hardwood
- Optional : Purchase and add lights, using manufacturers instructions

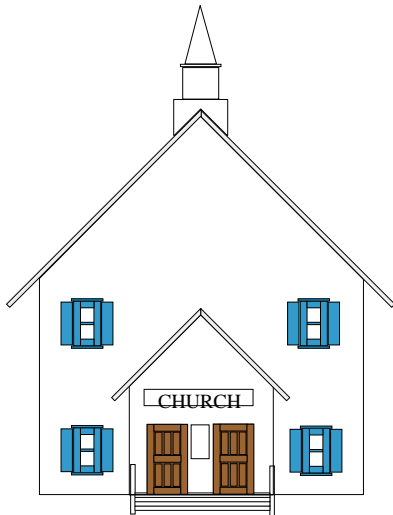

## Introduction

Thank you for purchasing our Garden Towns Church pattern. It was designed to accompany the Garden Town Houses and the Garden Town Buildings series. All were instigated by a happy retired "dad" who loves trains of any size and most recently the Garden Scale Trains. However, the scaled buildings can be used to add interest to your flower gardens, fish pond or whatever ideas you may have. They can be used as a backdrop toy for a child. They are as unique as you wish to make them and inspire a nostalgia for a few years gone by.

Enjoy your project!

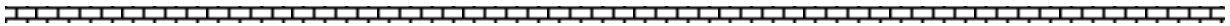

## Table of Contents

<b>Before You Begin</b>	Page
<b>Tools and Supplies</b>	
General	3
Door and Window Requirements	4
Working With Small Items	5
Layouts -	
Building and Frame	6
Stairs/Steeple/Rooftop pipe	7
<b>Hints and Tips</b>	
Two Ways to Assemble Roof	8
<b>Patterns</b>	
Building	9
Frames for Foundation and Walls	10
<b>Stairs</b>	
Patterns	11
Assembly	12
<b>Steeple</b>	
Patterns	13
Assembly	14
<b>Walls</b>	
Door and windows placements	15
<b>Assembly</b>	
Walls	17
Building	19

A note about the Doors and Windows

**Opening Type Doors** -If you use commercially purchased doors, you will have to cut into the house frame. Our illustrations show how to make the opening. The size of the opening will depend upon the doors and windows you purchase and the instructions which come with them.

**Non-Opening Doors**-Such as Kiva Design Garden Town Doors and Windows, which you build yourself, you can build a simple "box frame" for the house. The window openings will be above the frame and the 1/8" thick doors will fit into the 1/4" walls.

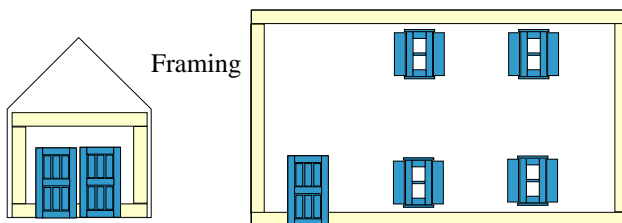

Non-opening door can be installed without cutting into the frame

- Buildings are constructed from 1/4" thick plywood
- Framing for the walls is made from 1" Furring strips (nominally 3/4" thick)
- Garden Town Doors and Windows are made from 1/8" thick Balsa wood or Hardwood and plastic glazing for the window panes
- Windows and doors have to be at least 1" from sides and top (to clear inside building frame)
- Doors are placed at floorline
- For a few hints to experiment with on the wall finishes, see "Simulated Patterns" in our free **Food For Thought** brochure.

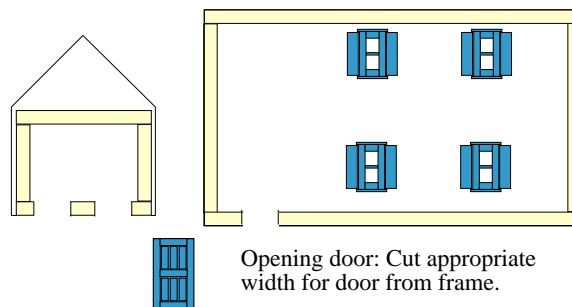

Opening door: Cut appropriate width for door from frame.

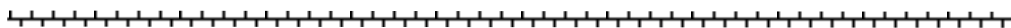

**Tools Needed for Building**

- Saw (for cutting small wood pieces, a jig saw or coping saw)
- Hammer or Stapler or Air Gun
- Optional Drill for pilot holes
- Clamps
- T-Square
- Level
- Ruler and Pencil (We prefer see-thru rulers with grids for the small pieces)

**Plus If you are making Doors & Windows from Balsa wood**

- X-Acto knife and metal ruler for guide
- Optional:**
- Ruler - the plastic see-thru kind with 1/8" grid is a plus
- Balsa stripper - This little gizmo is used for making various widths of uniform strips from balsa wood. You can set it to cut small widths, (1/8", 1/4", 1/2" etc.)It saves a lot of time if you prefer to cut your own strips.
- Of course you can buy the strips "ready made" at a higher price.
- Clamps (small) - For example, the X-Acto clamps for small pieces are very handy.

**Supplies Needed - General**

- 5/8" Staples or Brads
- 3/8"-1/2" Small flat head wood screws
- 2" Finishing Nails
- Wood Glue
- Paint or Stain-
- We suggest the water based Acrylic Paints found in a multitude of colors in arts and crafts stores.
- Sealer - Water Base Varnish found with the acrylic paints or a sealer such as polyurethane.
- Optional: Caulking for sealing porches, roofs, etc.

**Optional - Items to consider from the hobby store:**

Lights- Add Lights according to manufacturers instructions.

You can buy scaled wood shingles for your roof, as well as assorted other detailed items. Make your own signs with help from a stencil or the stick-on letters and numbers available.

Guide  
for 1" x 1" x 8'  
Furring Strips

1	8'	96"
2	16'	192"
3	24'	288"
4	32'	384"
5	40'	480"

<b>Specific Building Supplies</b>		For Details See Page
<b>1/4" Plywood</b> (No. of Sheets)	48" x 70" (1) 4' x 8'	6
<b>1" Furring Strips (nominally 3/4" x 3/4")</b> Walls	264"	6
<b>Purchased Doors &amp; Windows</b> or <b>1/8" Balsa or Hardwood (4" x 36" Boards)</b> Doors & Windows	3**	4
**If you prefer to buy ready made strips for the windows and doors, see page 4		
<b>1/8" Hardwood (4" x 36" Boards)</b> Steeple & Stairs	2	7
Optional -Add (2) 1/8" x 1/4" x 36" Strips for stair risers		
<b>Clear Plastic Glazing for Windows</b> 8" x 10" Sheet	1	4
<b>Wood Dowel</b> Rooftop pipe	3/8" x 2"	7
Optional Small Parts Frame - Page 5		
1/4" Plywood - No extra needed		
1" x 1" Furring Strips - Add 52"		

## Doors and Windows

Option: You can purchase ready-made doors and windows which actually open. For example, Grandt Line carries a well made and ready to paint plastic selection for Scale 1:24.

or

you can make your own (Garden Towns Doors and Windows Patterns by Kiva Design) These doors and windows are also 1/24 scale, but are a little larger overall for ease in building. They are non-opening (no hinges).

The following are samples represented for the scaled dimensions.

Buildings are illustrated with the Kiva Design Samples. Neither of the samples are inclusive all all doors and windows available.

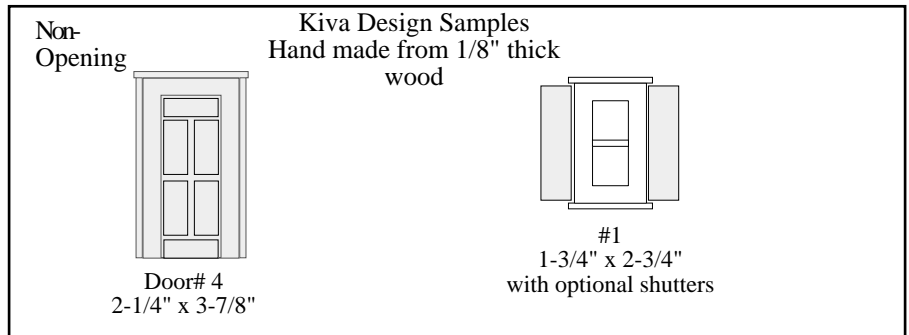
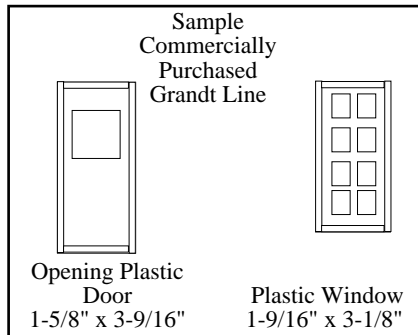

- Purchased Doors and Windows as required
- OR
- 1/8" Balsa wood or Hardwood for Doors and Windows:  
4" x 36"  
(common size at hobby shops)  
See specifics below

Number of Doors and Windows required for Church	
Doors*	Kiva Design # 1 Windows*
3	16

- Clear Plastic for Windows  
8" x 10" Sheet  
(from hobby shop framing area)

<ul style="list-style-type: none"> <li>•1/8" thick Balsa Wood or Hardwood Need 3 (4" x 36") boards for making complete doors and windows for Church (you will be cutting strips from the boards)</li> </ul>	<p>Or</p> <p>Alternately if you prefer to use ready made strips, you will need the following: Purchase 1/8" thick Balsawood or Hardwood</p> <hr/> <p>Amount Needed:            1 - 4" x 36" Board for Doors &amp; Windows</p> <p style="text-align: right;">1 - 1/8" x 18" Strip 5 - 1/4" x 36" Strips 3 - 3/8" x 36" Strips 3 - 5/8" x 36" Strips 1 - 1/2" x 18" Strip</p>
---	---

\*Doors and windows shown for the building can be made from the number of boards indicated. However, "we" personally always buy one extra board in the unlikely event that we'll need it to redo our "errors". Left-overs are saved for the next project.

### Assembly Frame for Small Items

Cut from plywood -1/4" thick or any scrap

#### Patterns

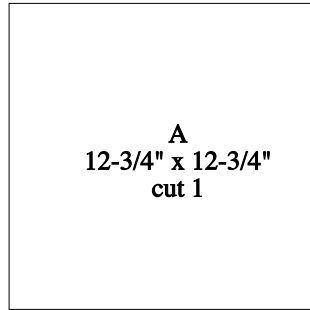

Cut from 1" x 1" Framing (nominally 3/4" x 3/4")

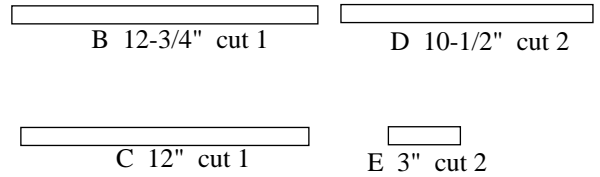

#### Assembly

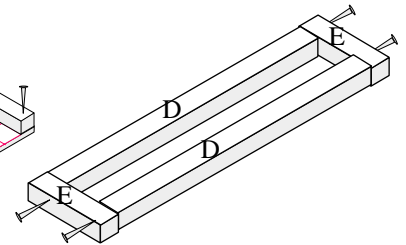
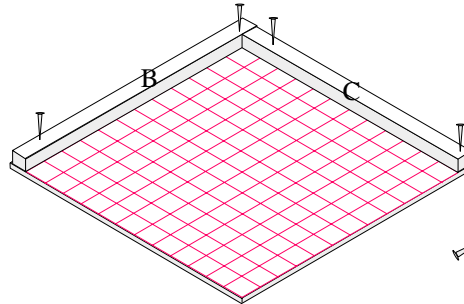
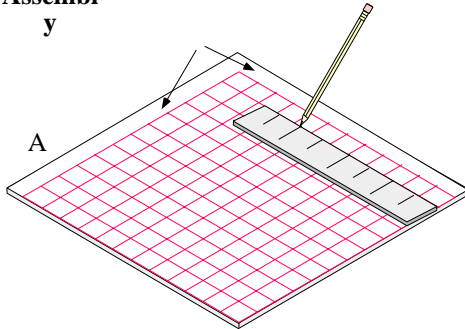

- Using pencil or pen and ruler, draw lines 3/4" inside of 2 adjacent sides of the base. The frame will be placed in this area. From those 2 lines, draw lines at 1" intervals, forming a 1" grid.

- Nail and glue frame parts B and C in place, as shown, maintaining a square corner.

- Using glue and nails, assemble the frame "push bar", as shown. Again, make sure that the corners are square.

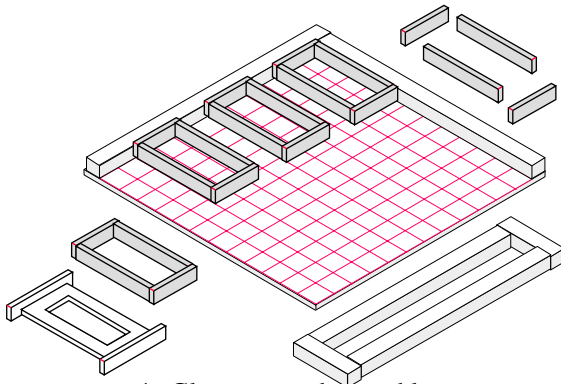

- Glue parts and assemble inside the frame. The grid will help you keep the pieces straight. You can assemble several "like" pieces at one time.

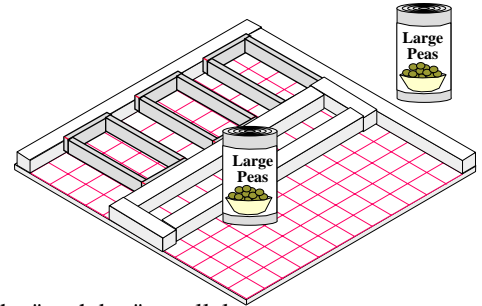

- Keep the "push bar" parallel to side C and push it firmly against the assembled parts. Use anything with weight to hold the push bar in place until parts are dry. Canned goods you didn't want for dinner work well.

### Trimming 1/8" Balsa wood or hardwood



- Using ruler and pencil make a line 1/8" from the inside edge to be mitered

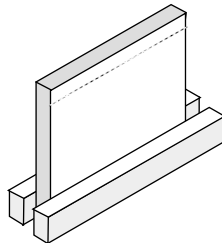

- Stabilize the piece to be mitered with a clamp or other means

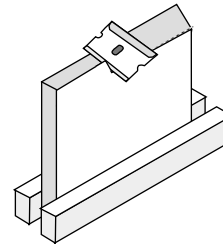

- With blade, carefully trim from the top outside to the marked line. Alternately, the piece can planed or sanded.

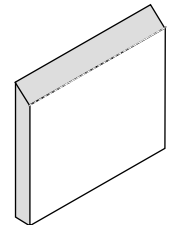

Trimmed on the inside

**Church  
Layout  
Cut from 1/4"  
Plywood  
48" x 70"**

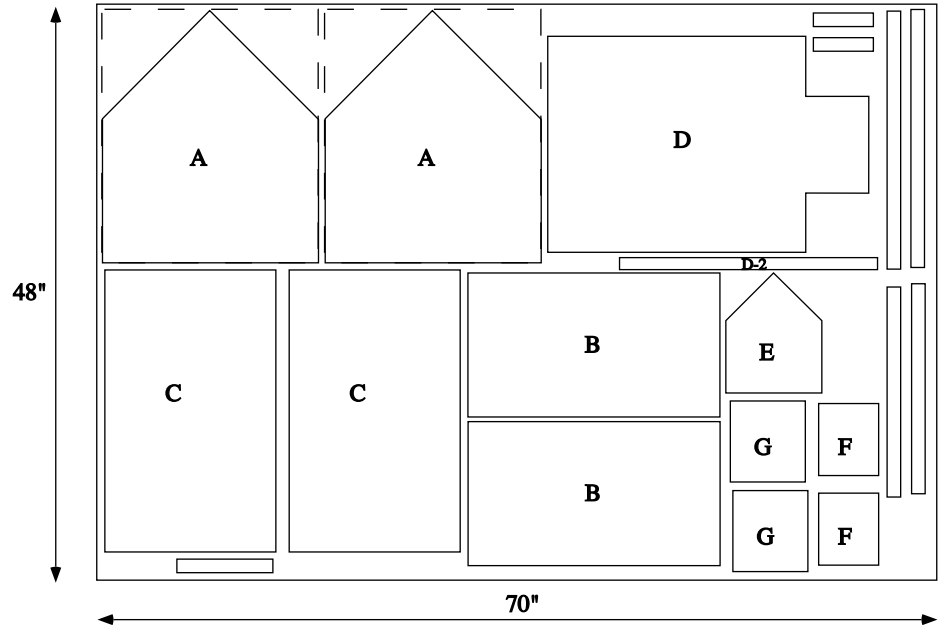

See Frame Patterns, Page 10  
and Frame Assembly, Page 19

**The Frame**

You will need to build a frame  
for which to attach the walls.

If your building will have doors which  
do not physically open, you can build  
a simple box for your wall braces.

The windows and doors will fit  
into the walls.

If your building will have doors which  
do physically open, you will be cutting  
an opening in the floor frame.

Vertical Braces for the Church are  
Church: 10-1/2" high  
Addition: 4-1/2" high

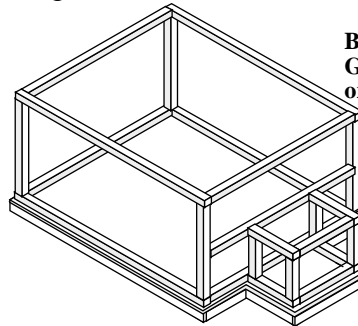

**Build this frame if you are using  
Garden Town Doors and Windows  
or other non-opening doors**

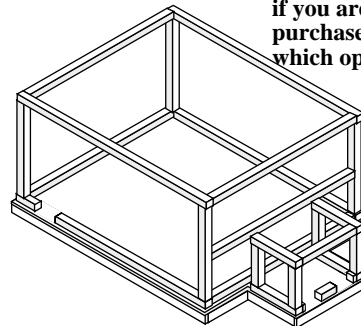

**Build this frame  
if you are using  
purchased doors  
which open**

**1" Furring Strips for Framing Church  
(nominally 3/4" square\*)Patterns are on page 10**

4 @ 21"	84"
5 @ 16"	80"
2 @ 6"	12"
4 @ 5"	20"
4 @ 10-1/2"	42"
4 @ 4-1/2"	18"
<b>Total needed for walls</b>	<b>256"</b>
<b>Add for foundation braces (page 19)</b>	
<b>8 @ 1"</b>	<b>8"</b>
<b>Total</b>	<b>264"</b>

Conversion	
Inches =	Feet
12"	1'
24"	2'
36"	3'
48"	4'
60"	5'
72"	6'
84"	7'
96"	8'
108"	9'
120"	10'
132"	11'
144"	12'
156"	13'
168"	14'
180"	15'
192"	16'
204"	17'
216"	18'
228"	19'
240"	20'
252"	21'
264"	22'
276"	23'
288"	24'
300"	25'

\*Note: If your framing material is a different size  
than 3/4" square, adjust your horizontal pieces  
to fit the diagram for Frame Placement shown  
on page 10.

**Stairs and Steeple**  
Cut from 1/8" thick  
Balsa wood or Hardwood

Small stairs 12-1/2"  
Large stairs 15-1/2"  
Steeple 22-1/2"  
Total 50-1/2"  
or  
(2) 4" x 36" boards

**Layout for Small Stairs**

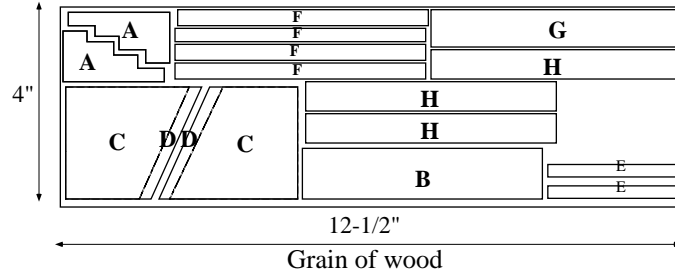

**Layout for Large Stairs**

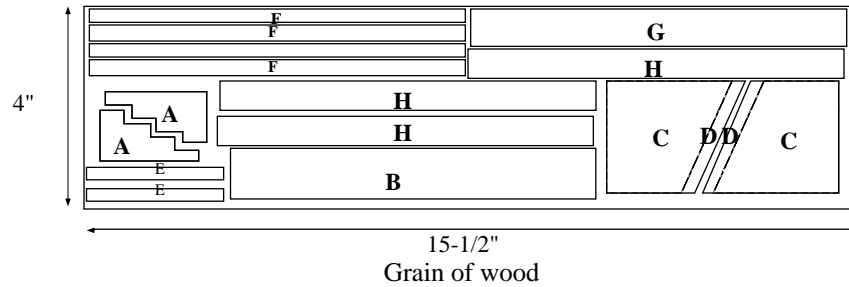

**Layout for Steeple**

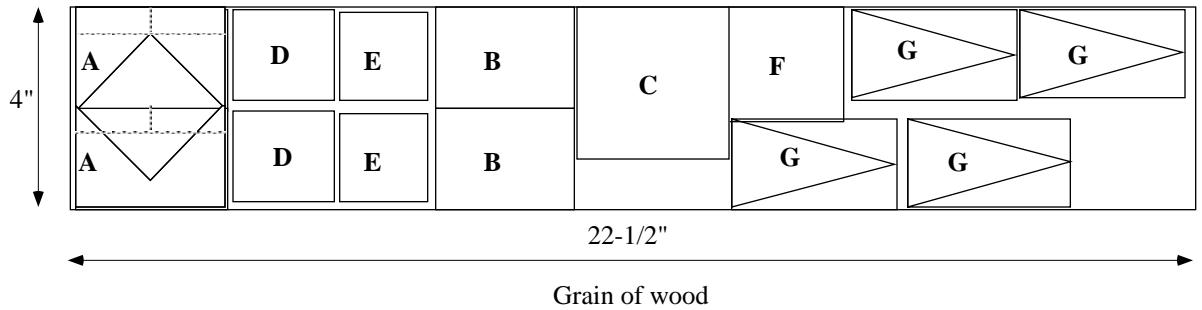

**For rooftop pipe**

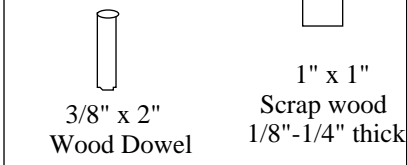

**Assembly - rooftop pipe**

1. Miter the 2" Dowel at 45° angle on bottom.

2. Lay base on a flat surface and glue the dowel to center. Paint the pipe assembly before attaching to roof.

3. When the assembly is attached to the roof, the dowel should be straight up. Attach base to roof with glue.

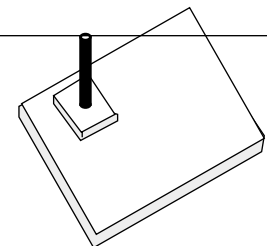

**Roofs made from 1/4" plywood**

There are two ways to assemble your 45° roof. Either way will allow the two halves to meet at the top smoothly.



Areas that need to be mitered in order to fit will be designated with this icon on the pattern. The specific mitering angle is noted on the pattern page.

**Method 1 - Miter the Tops**

The first and more professional procedure is to miter the top edges of the roof halves on the inside. One way you can do this is to cut out the roof with a jigsaw which has an adjusting base plate. Example:

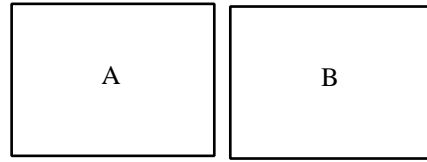

Both roof halves are the same size



Side view

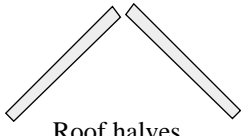

Roof halves before mitered

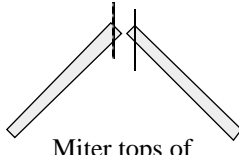

Miter tops of both halves at the same angle

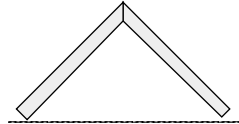

Roof halves mitered at top now fit together

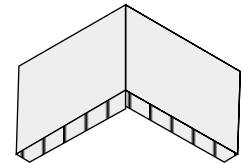

Top view of mitered roof

**Optional:**

As a matter of taste, you may also choose to miter the inside bottom edge of the roof. If you miter the bottom of the house roof, you should also miter all addition roofs you will use with the house.

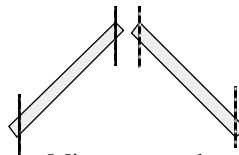

Miter tops and bottoms of both halves at the same angle



Side View with Top and bottom edge mitered

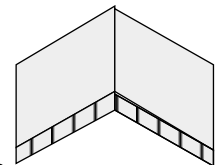

**Side wall Option**

Mitering the side wall will allow the roof to fit better.

Side wall mitered at top on the outside. Miter at same angle as roof

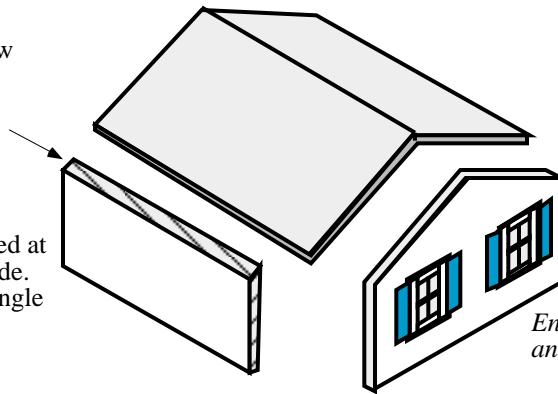

End walls are already angled to fit the roof.

**Method 2 - No Mitering**

Add 1/4" to the height of one roof half only

Example

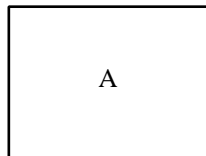

Roof half A is 3" high x 4" long

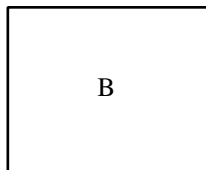

Roof half B is 3-1/4" high x 4" long



Side view

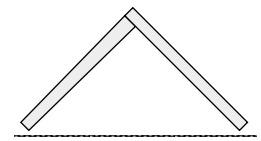

Fit roof halves together

**Roofs made from 1/2" plywood**

Add 1/2" to the height of one roof half only

No matter what depth of wood you use, always add the depth of the wood to one half only



**Patterns-the Building**  
Cut from 1/4" Plywood

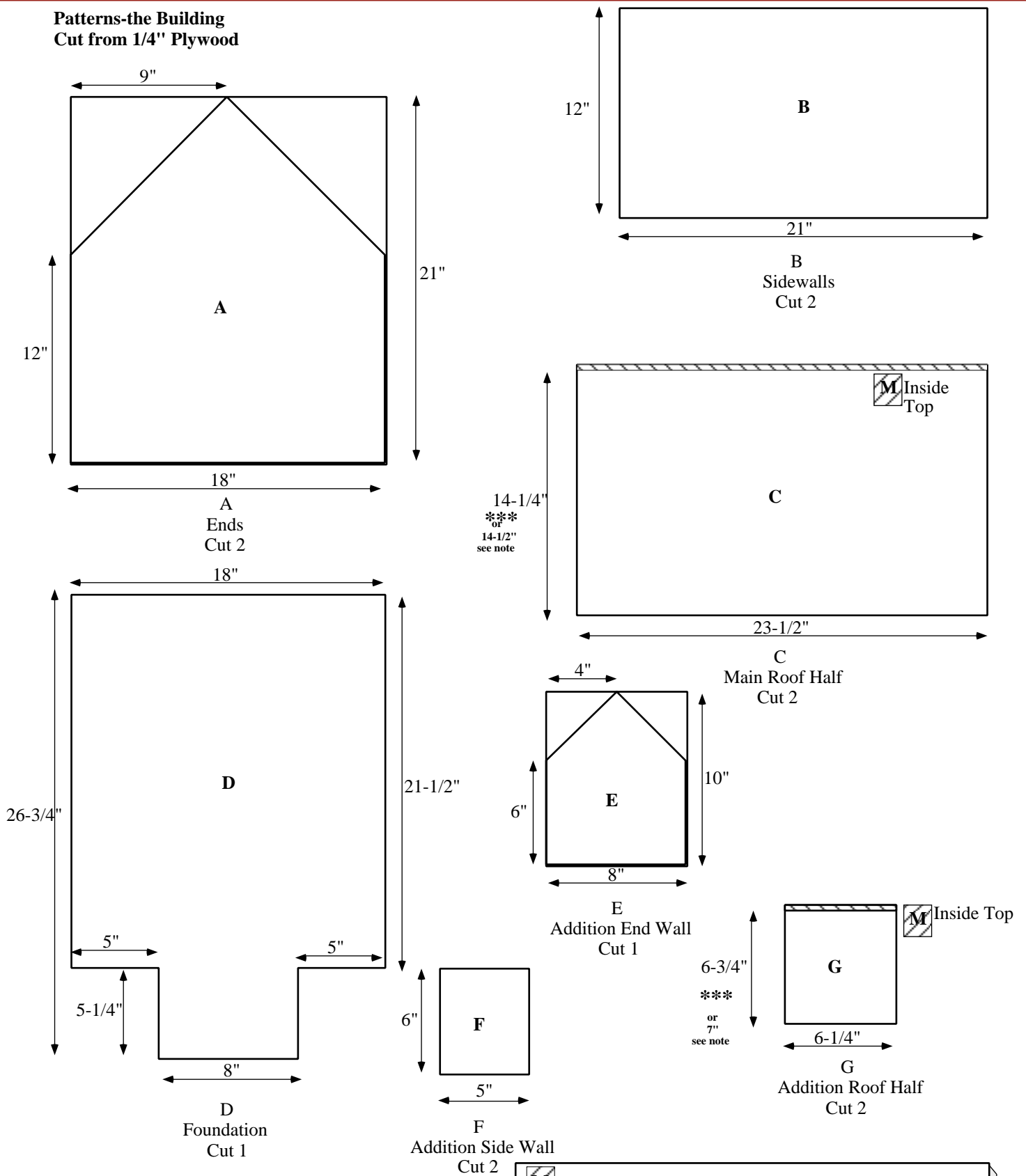

M Miter @ 45°

\*\*\*See Before You Begin - Hints and Tips  
Two Ways to Assemble 45° Roofs  
For non-mitered roof, add 1/4" to height for one roof half only

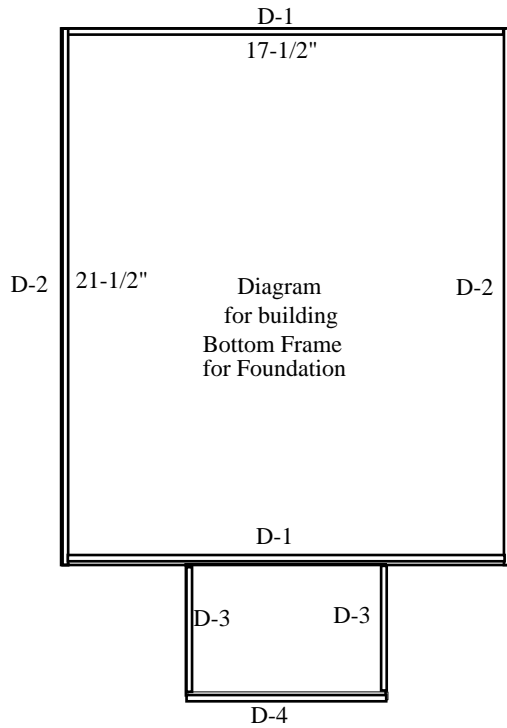

Cut from 1/4" Plywood

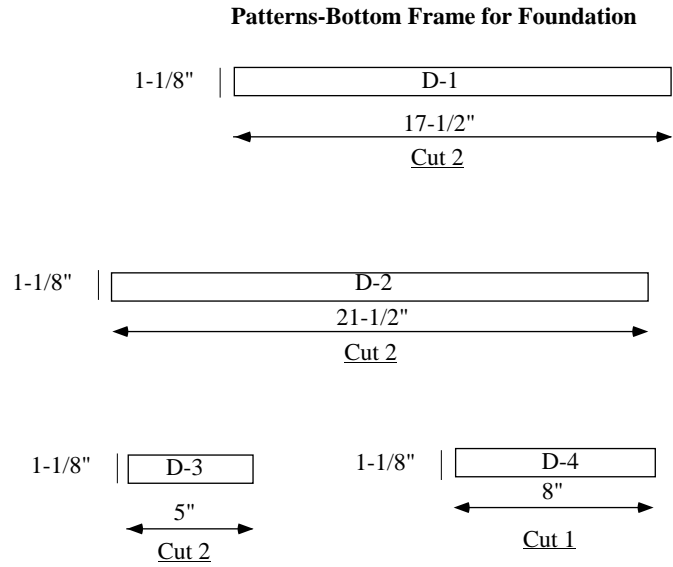

Cut from 1" Furring Strip (Nominally 3/4")

\*Note: If your framing material is a different size than 3/4" square, adjust your horizontal pieces to fit the diagram for Frame Placement shown below.

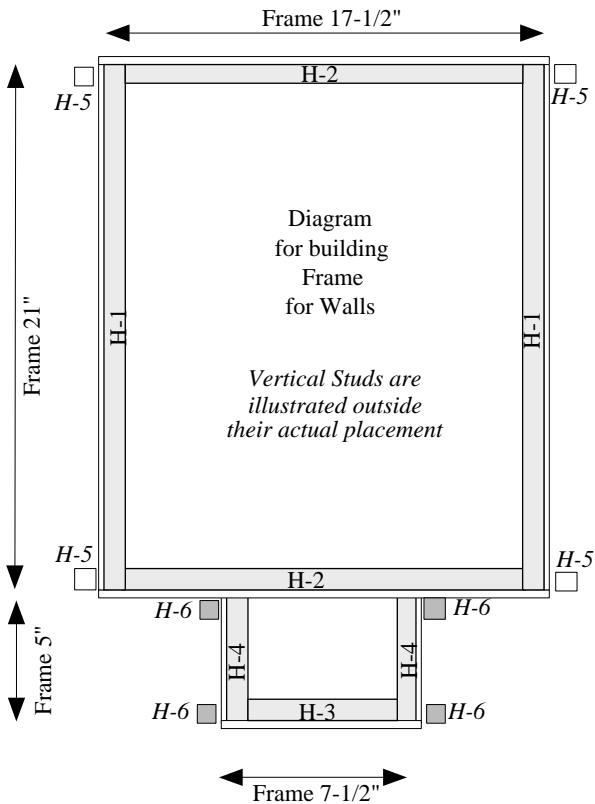

Corner Braces for Foundation Frame

1"  
Cut 8

Patterns- Frame for Walls

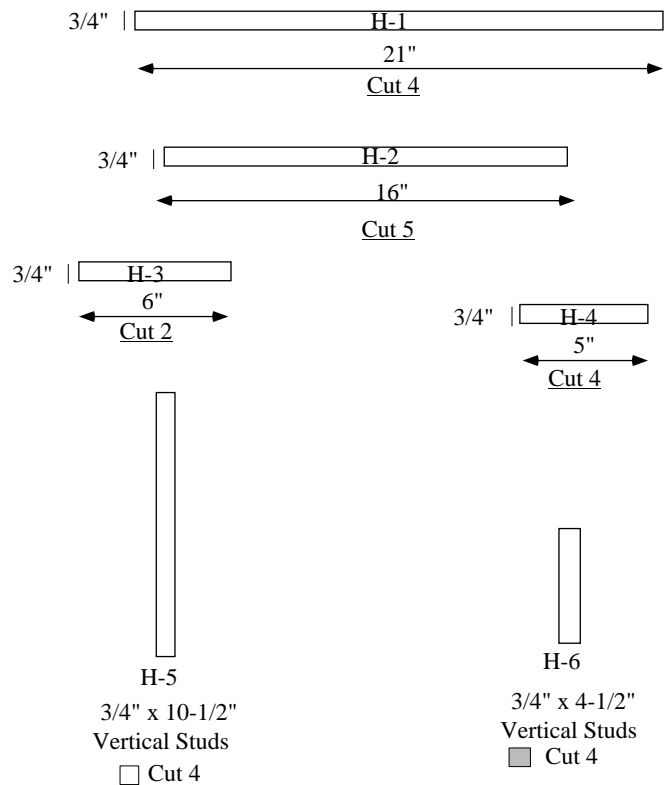

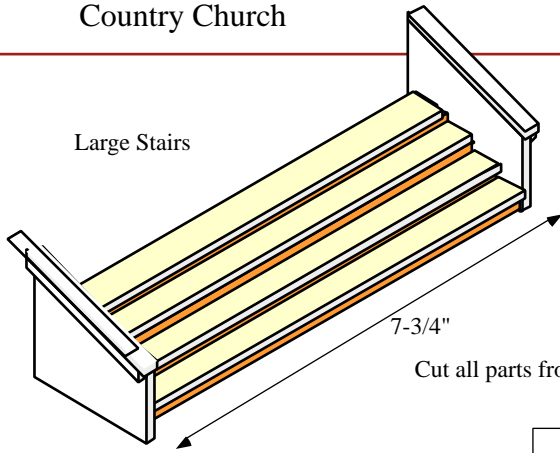

Large Stairs

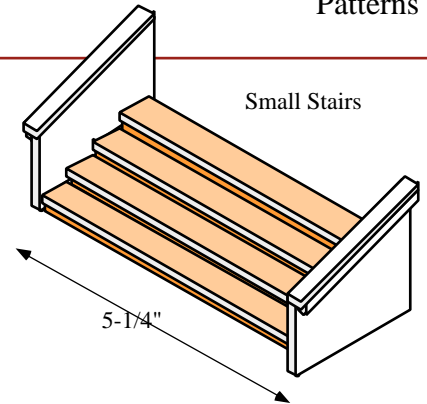

Small Stairs

Cut all parts from 1/8" thick Balsa wood or Hardwood

Quantities are for two sets of stairs (large and small)

Use  
Parts A, C, D and E  
with large or small stairs

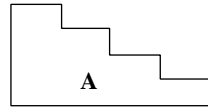

A  
Stair Frame  
see Actual Size Detail  
Cut 4

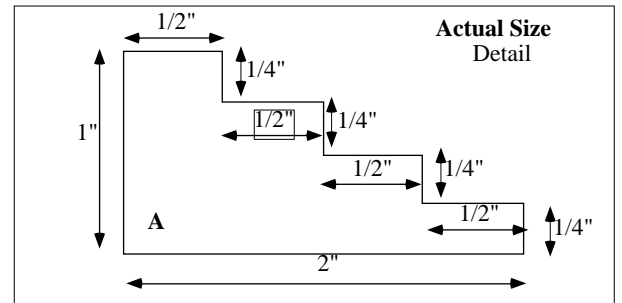

Actual Size  
Detail

C  
Stair Ends and  
D  
Brace for Top  
Measure and cut D from C  
see Detail  
Cut 4

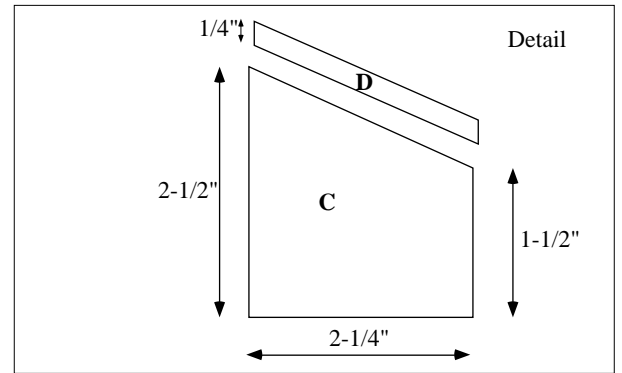
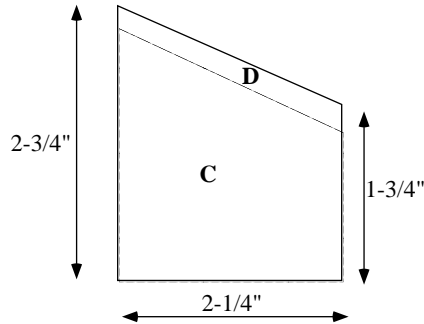

Detail

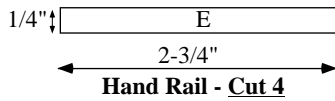

Hand Rail - Cut 4

Use Patterns Below for Large Stairs  
along with A, C, D and E above

Use Patterns Below for Small Stairs  
along with A, C, D and E above

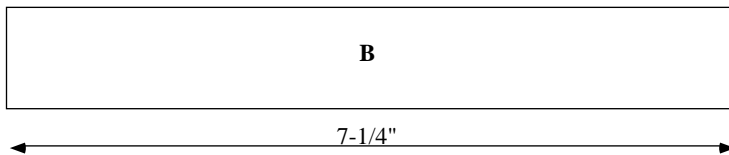

B -Stair Back Brace - Cut 1

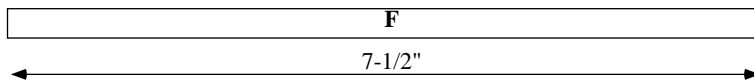
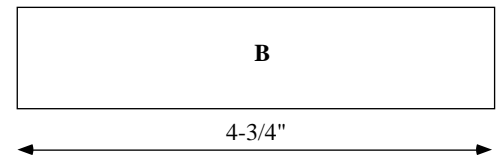

F -Step Risers - Cut 4

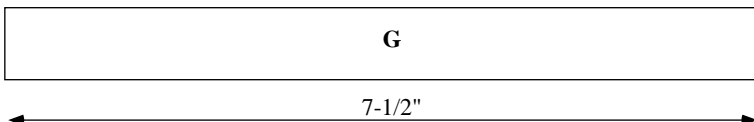
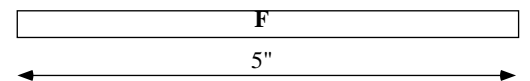

G -Top Step - Cut 1

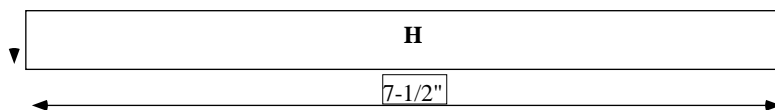

H - Bottom Steps - Cut 3

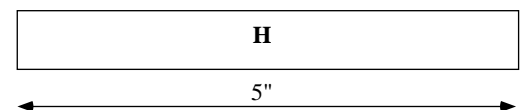

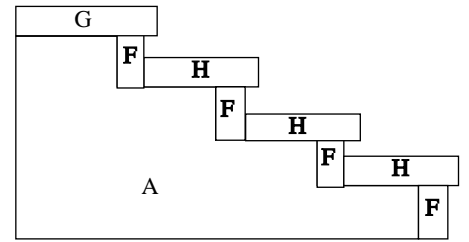
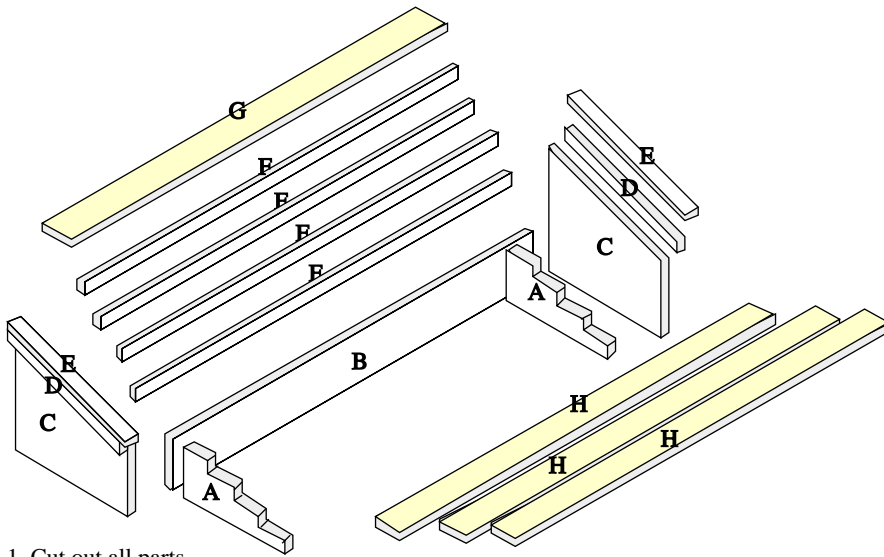

Side View of Step Assembly

1. Cut out all parts

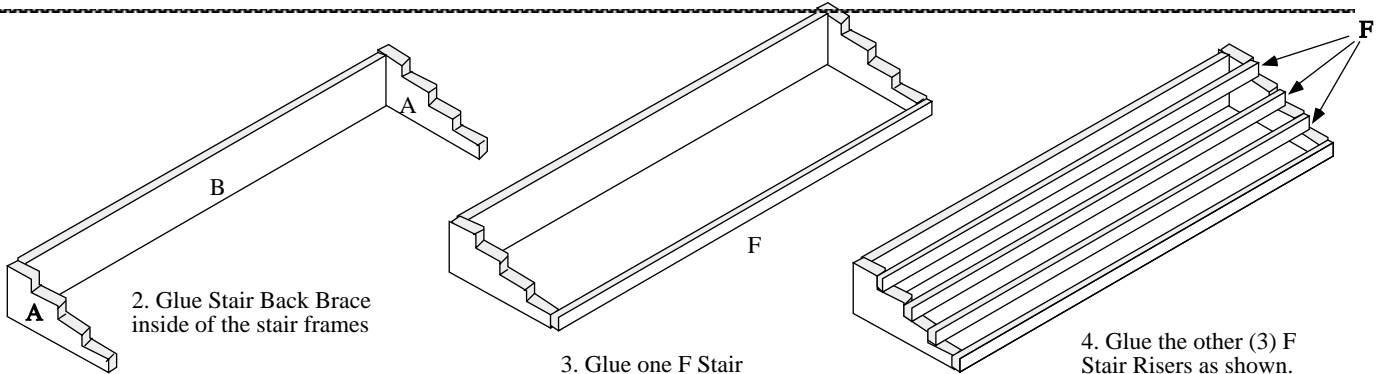

2. Glue Stair Back Brace inside of the stair frames

3. Glue one F Stair Riser to the front of the stair frames.

4. Glue the other (3) F Stair Risers as shown.

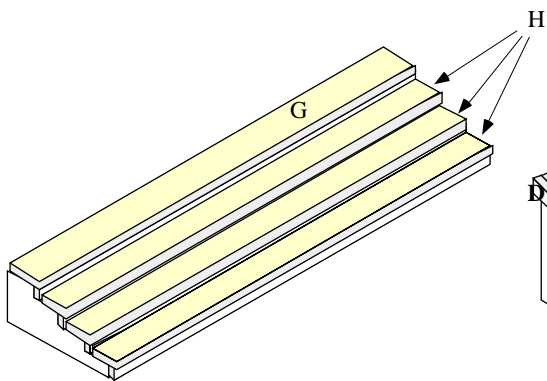

5. Glue Top Step G to the top and the (3) bottom steps H in place, as shown. There will be a 1/16" overhang on the steps.

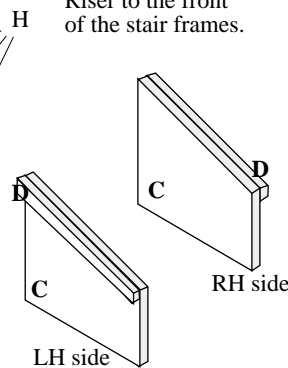

6. Glue Brace for Top D to End C, as shown.

7. Center and Glue Top E to the tops of C and D.

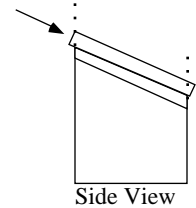

8. Turn the assembly sideways. Trim off the top so that it is parallel vertically with the end and will fit flush against building.

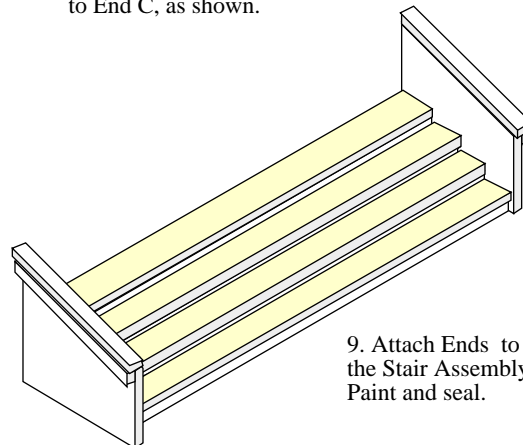

9. Attach Ends to the Stair Assembly  
Paint and seal.

**Patterns**

Cut from 1/8" thick Balsa wood  
or Hardwood

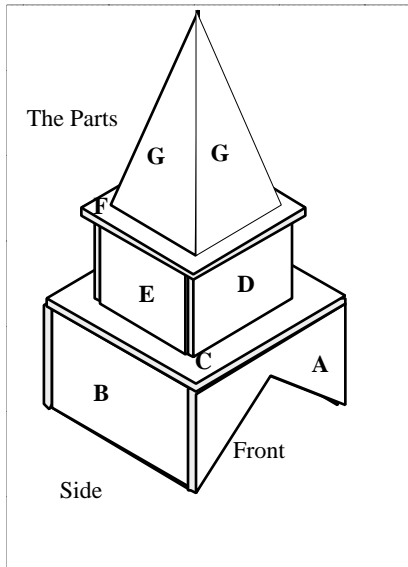

**Steeple Base**

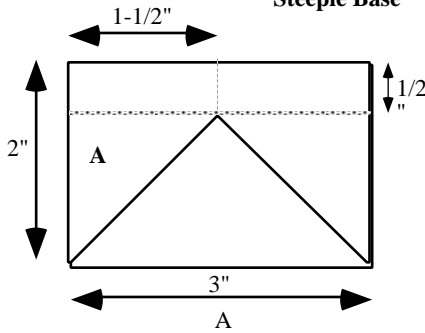

A  
Roof mount base  
front and back  
Cut 2

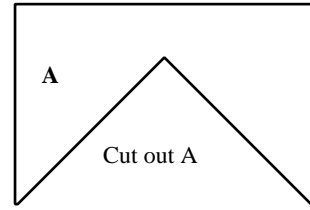

Cut out A

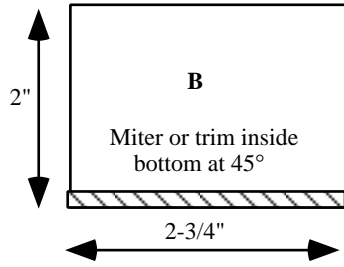

B  
Roof mount base sides  
Cut 2

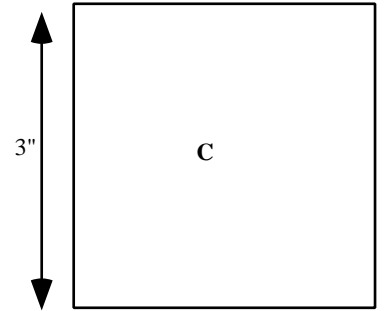

C  
Top for roof mount base  
Cut 1

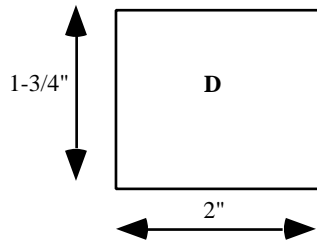

D  
Top base  
front and back  
Cut 2

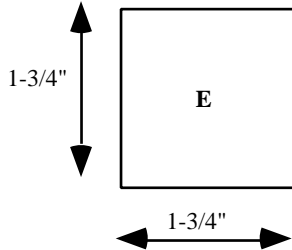

E  
Top base sides  
Cut 2

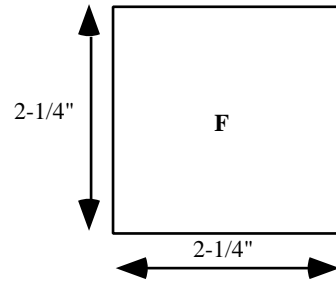

F  
Top for top base  
Cut 1

**Steeple Top**

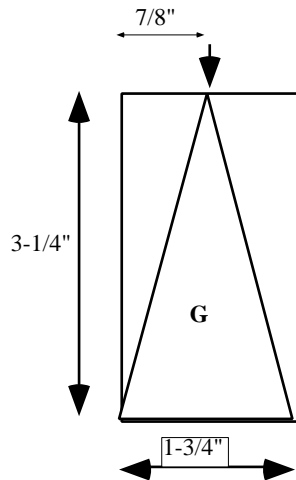

G  
Steeple Top  
Cut 4

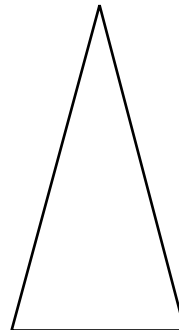

Cut out  
triangle

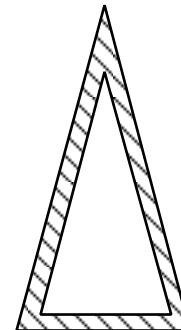

Miter or trim all  
inside edges

Cut out all parts, per pattern instructions.

The Parts

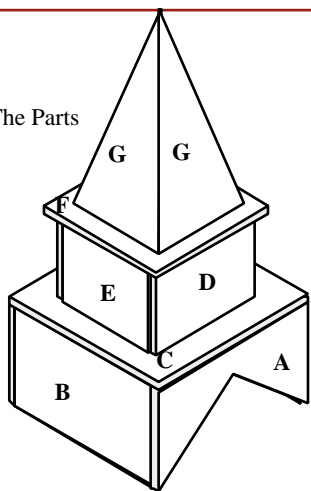

**Steeple Base**

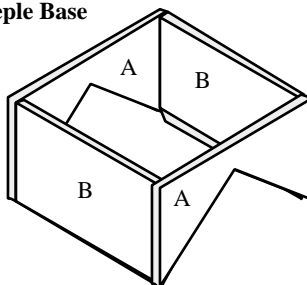

1. Make a square box with Fronts A and Sides B. B is assembled inside of A

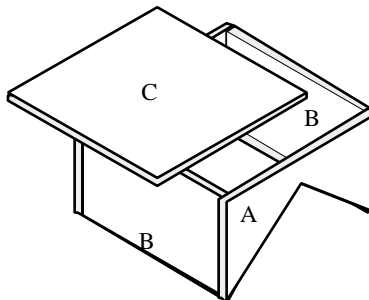

2. Glue Top C onto the Roof Mounting Box

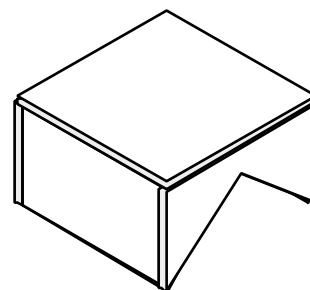

Roof Mount Frame

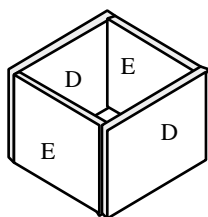

3. Make a smaller square box with Fronts D and Sides E. E is assembled inside of D

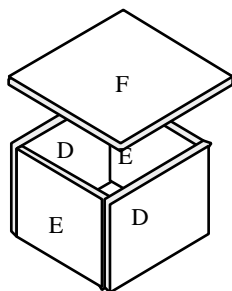

4. Center and glue Top F onto the smaller box

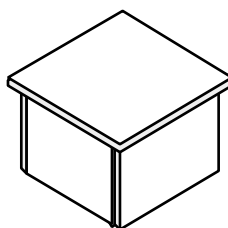

Top Frame

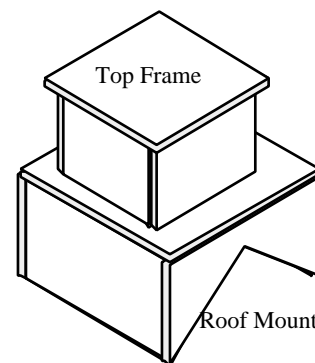

5. Center and glue the Top Frame onto the Roof Mount Frame

Roof Mount Frame

**Steeple Top**

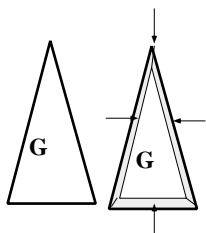

6. Trim all inside edges as much as possible, leaving a thin edge on all sides. Carefully trim the top point.

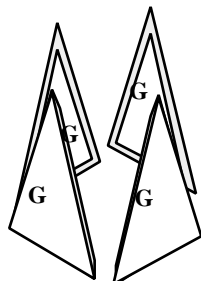

Trimmed edges will be assembled towards the inside of the steeple.

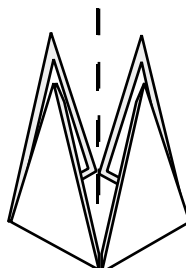

7. Form a square with the bases. The vertical line indicates the center of the square

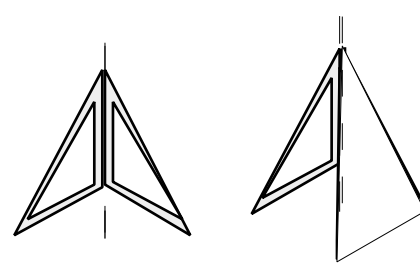

8. Glue all sides of the triangles. Bring the top points together while keeping the bases in place on the square.

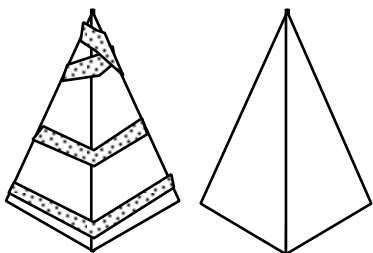

9. When all points are joined, your steeple top will be formed. We suggest tightly taping the steeple with masking tape until all joins are dry.

Note: if you have "cracks" in the joins when dry, just fill them with a dab of wood putty and sand smooth when dry.

10. Center and glue the finished steeple top to the steeple base.

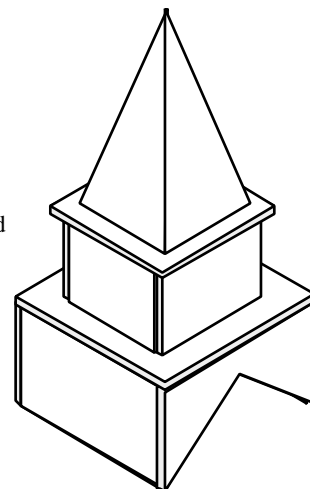

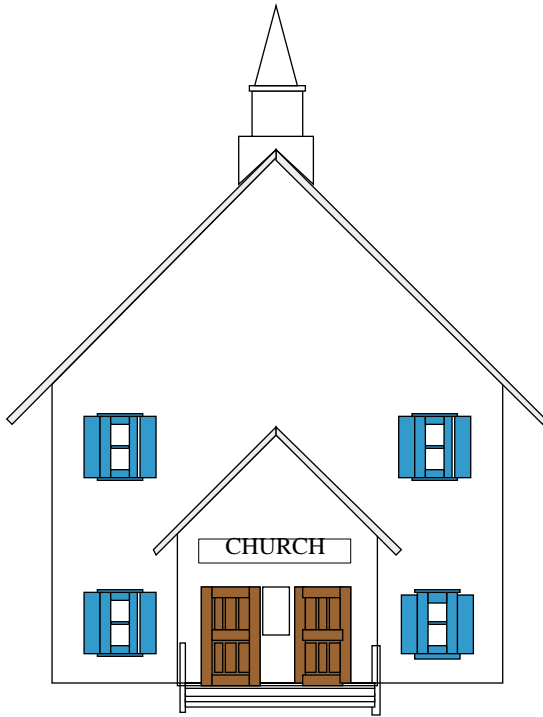

Front

Using ruler and pencil, draw lines on your walls as shown.  
The lines will be guides for your window templates and door placements.

Place window templates on lines as shown and mark your window cut-outs.

Bottom floor- templates will be placed on the floor line.

2nd floor- templates top will be placed on the 12" horizontal line.

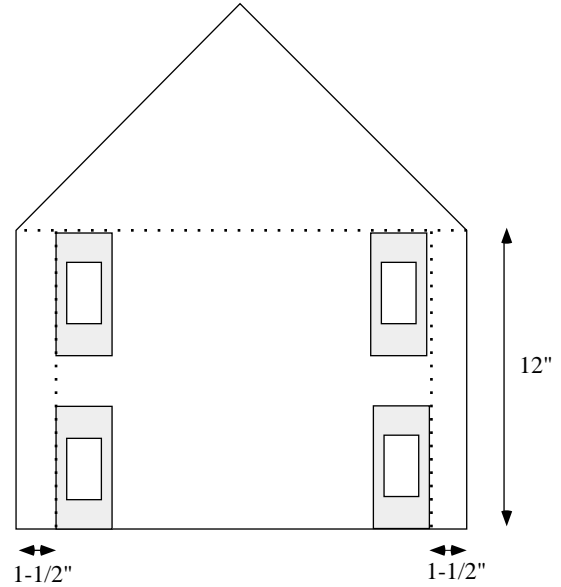

Vertical lines  
1-1/2" from each side  
Horizontal line  
12" from bottom

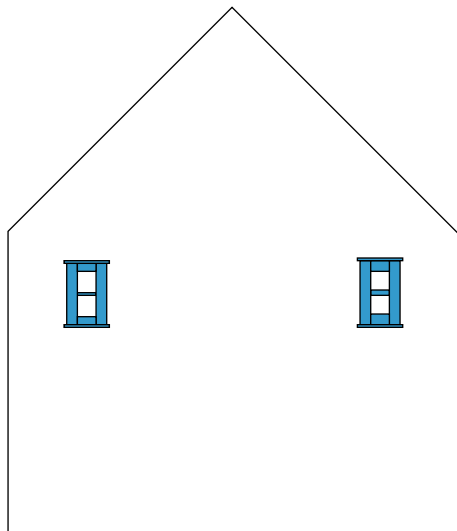

Back

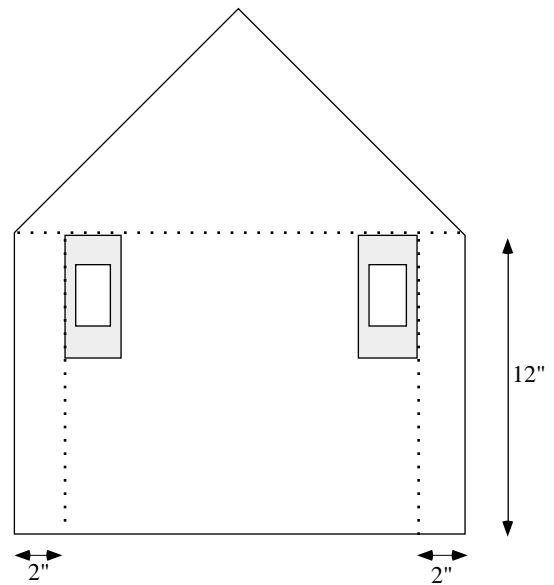

Vertical lines  
2" from each side  
Horizontal line  
12" from bottom

Using ruler and pencil, draw lines on your walls as shown.  
The lines will be guides for your window templates and door placements.

Place window templates on lines as shown and mark your window cut-outs.  
Bottom floor- templates will be placed on the floor line.  
2nd floor- templates top will be placed on the 12" horizontal line.

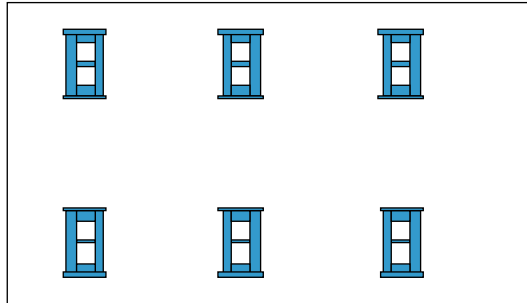

Side

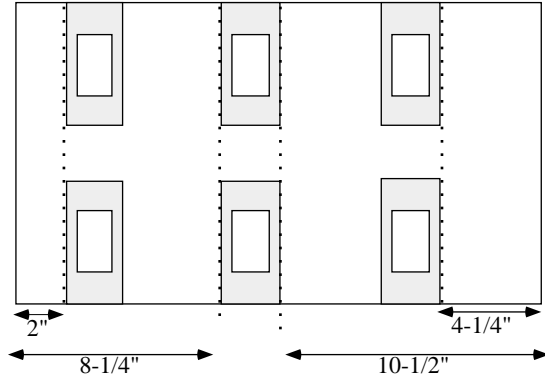

Vertical lines

**From Left Hand Side**  
2" and 8-1/4"

**From Right Hand Side**  
4-1/4" and 10-1/2"

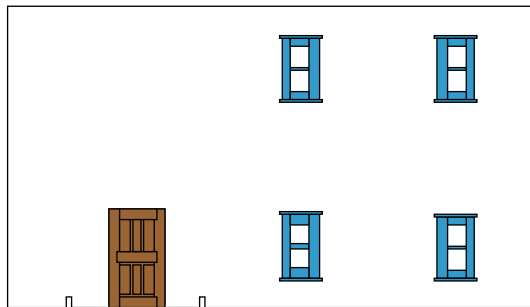

Side

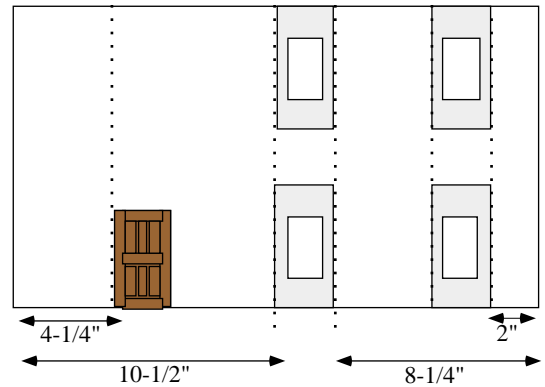

Vertical lines

**From Left Hand Side**  
4-1/4" and 10-1/2"

**From Right Hand Side**  
2" and 8-1/4"

If using purchased opening doors, use template  
which comes with the door  
Opening should be a minimum of 1-1/8" from side  
in order to clear the frame behind the wall

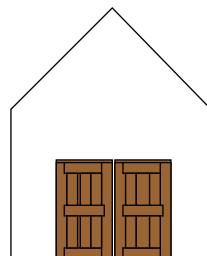

Addition End Wall  
Non-opening doors  
can be placed side by side  
or spaced

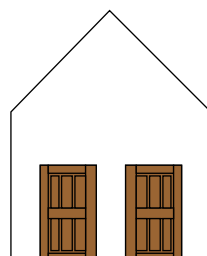

1-1/8" 1-1/8"  
Addition End Wall  
Opening doors



Addition Side Wall  
No windows



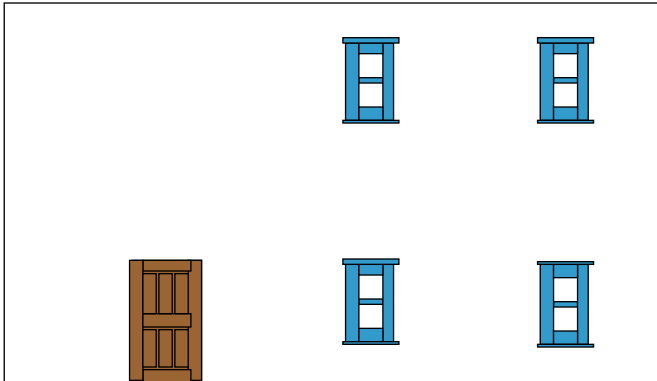
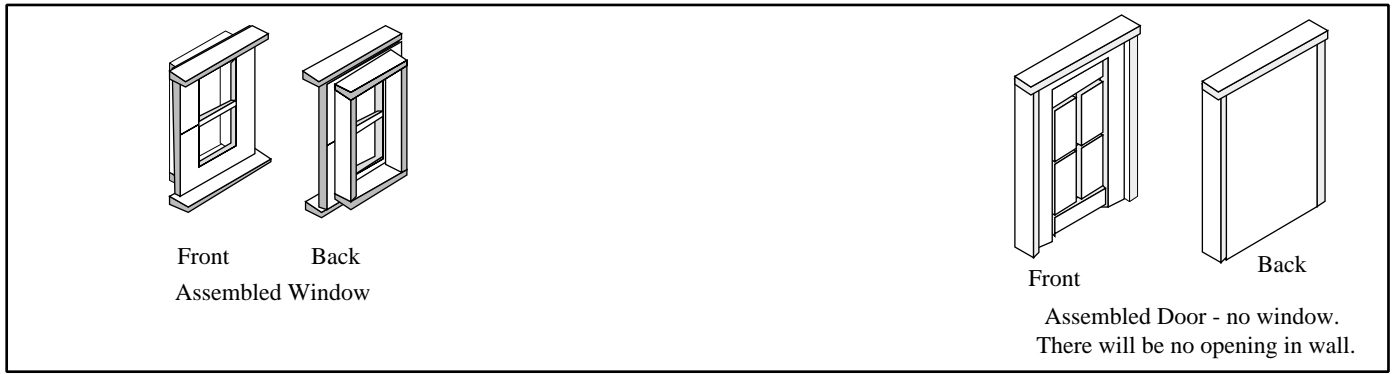

Window placement example

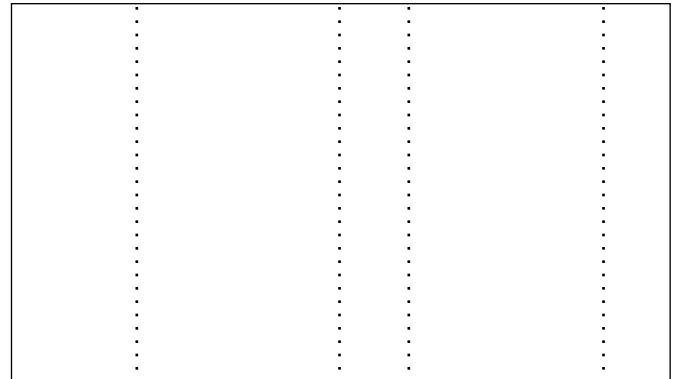

With pencil and ruler, lightly draw  
guide lines on the wall, as  
per wall instructions

**Template for Window Opening in Wall**

**Important:** After you cut out your template,  
check that the size and openings are accurate  
according to dimensions noted. Use a ruler to  
check.

*You can take a finished window or door and  
make sure that it physically fits into the template  
opening.*

Using your side guide lines, place the template as follows.

**Ground floor:**

Bottom of template will be on bottom of wall

**Sides - 2nd floor**

Top of template will be on the top of wall

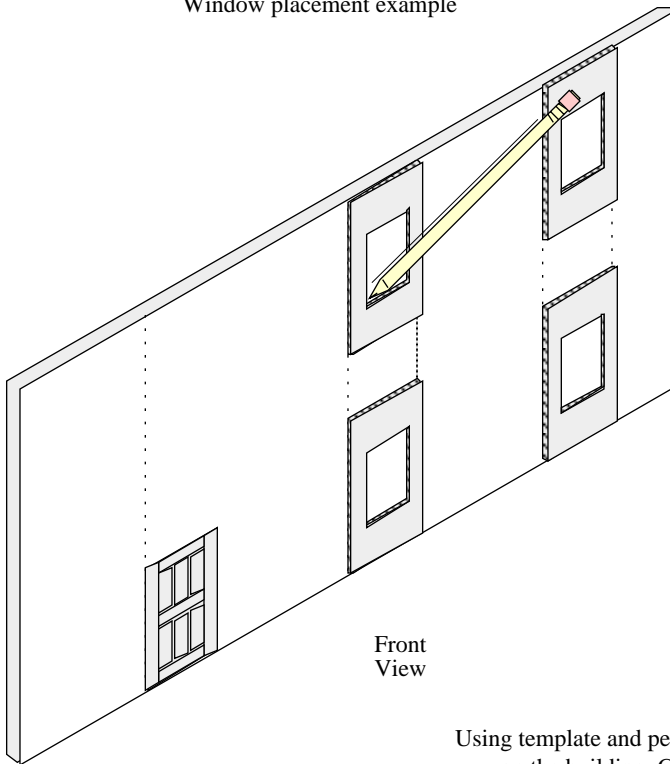

**Ends - 2nd floor**

Top of template will be on the  
12" horizontal line

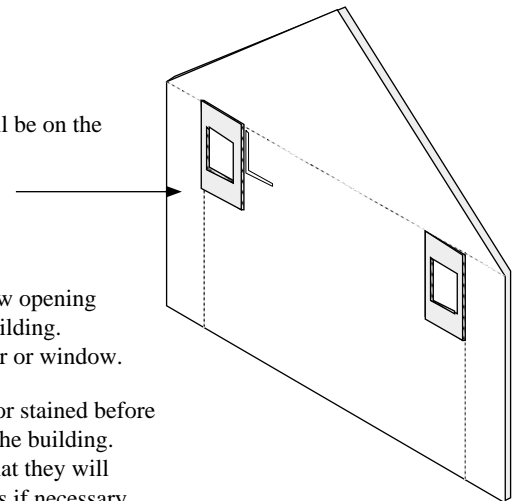

Using template and pencil, mark the window opening  
on the building. Cut out opening on building.  
The opening is now ready for the finished door or window.

Note: Doors and windows should be painted or stained before  
you actually insert and secure them into the building.

Before gluing windows, check to see that they will  
easily fit the wall openings. Trim openings if necessary.

Assemble the house before installing the doors and windows. See page 22

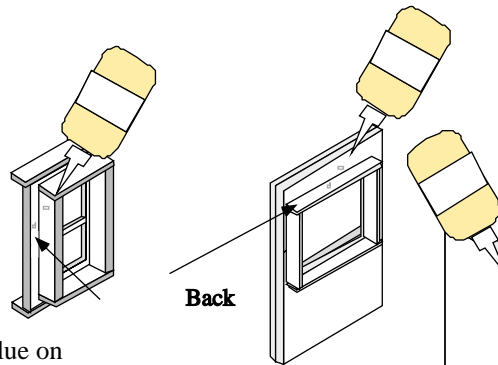

Place some wood glue on the flat backs of the finished window and door with window. (around the frame) This will adhere to the front of the wall.

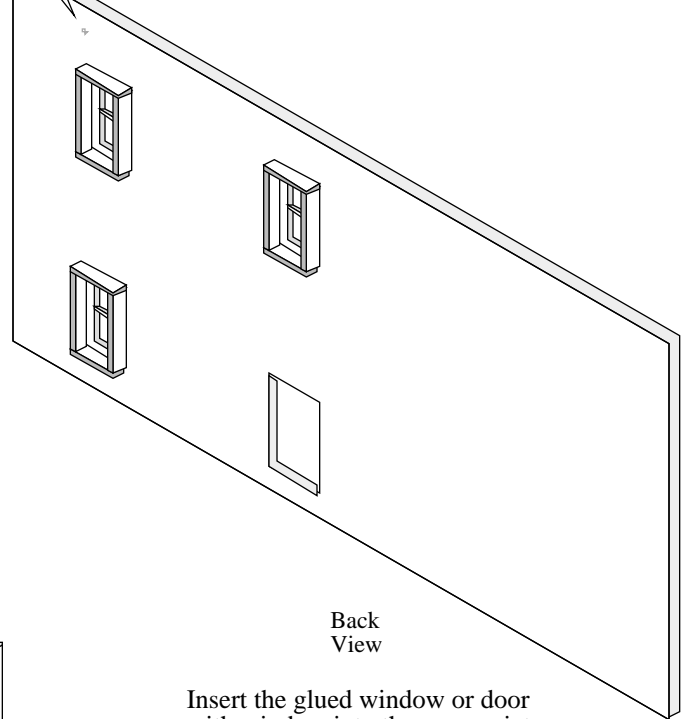

Back View

Insert the glued window or door with window into the appropriate wall opening. Look at the front side and using a level, make sure the window is straight.  
Run a bead of wood glue around the window brace. Allow the glue to dry.

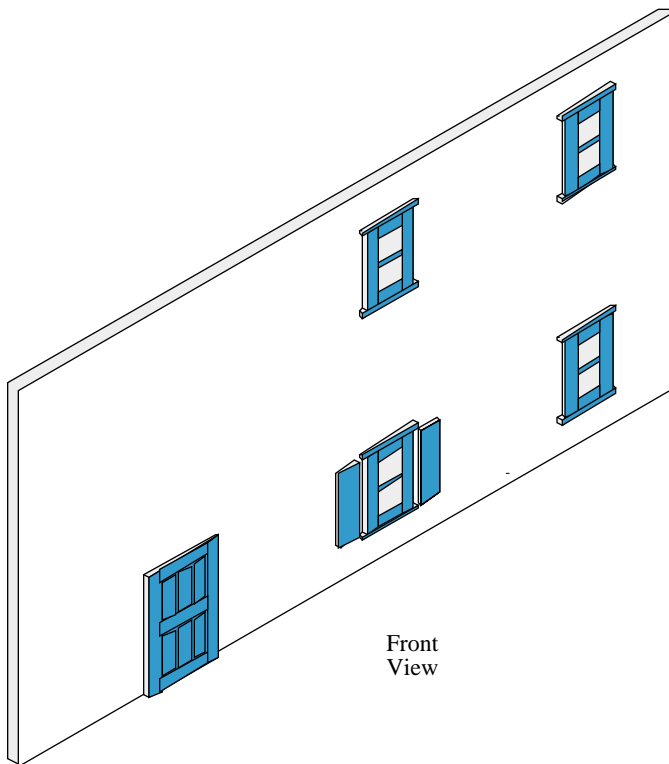

Front View

Door with no window does not have a wall opening. Glue door in place.

The following illustrations will show assembly of the church

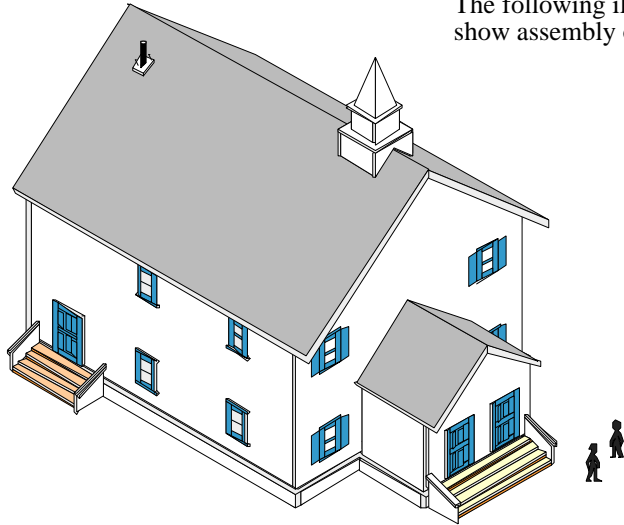

- Cut out all parts
- Cut openings for doors and windows as per wall instructions
- Assemble stairs, steeple and rooftop pipe according to individual instructions
- Build windows and doors if not purchased separately

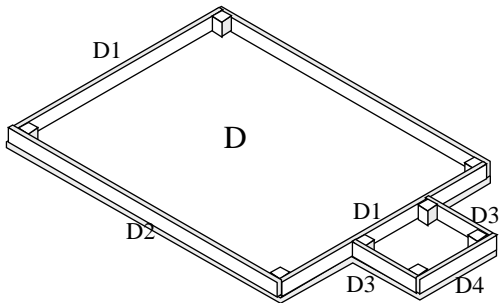

1. Bottom Frame for Foundation:  
Lay D Foundation upside down on a flat surface.  
Use the Diagram for building the Bottom Frame for Foundation (page 10)  
Glue the Frame pieces to the foundation. They will be at the very edge of the foundation. Check for squareness.

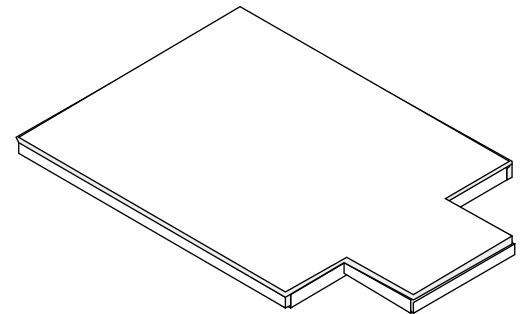

2. Turn assembled foundation right side up.

⊠ In each corner glue a 1" high furring strip brace to the bottom of the foundation and to the sides of the frame. Allow assembly to completely dry.

**Refer to Before You Begin  
Tools and Supplies  
The Frame**

**Do not cut opening in bottom frame brace if you are using Garden Town or other non-opening doors.**

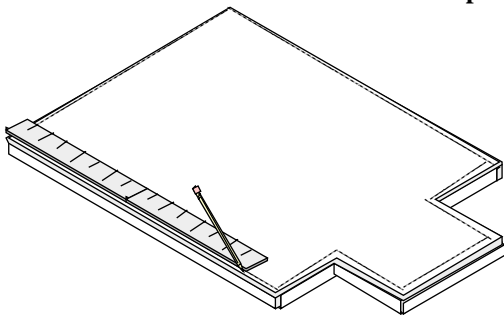

3. Foundation - prepare for frame  
Walls are 1/4" thick. With ruler and pencil, draw a line 1/4" inside the foundation edges for frame placement.

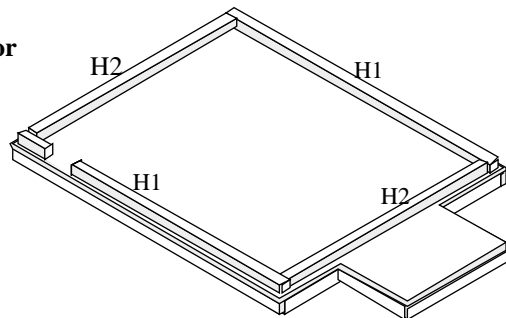

4. The Frame for Walls

Refer to the diagram for building Frame for Walls (page 10).  
Lay the frame pieces out on the foundation just inside the drawn lines.

Make sure the corners are square.  
If using opening doors, cut opening in frame where door will be installed. Width of opening will depend upon the size of door you will install. Go by instructions received with door.

Glue frame to the foundation. Go immediately to step 4A

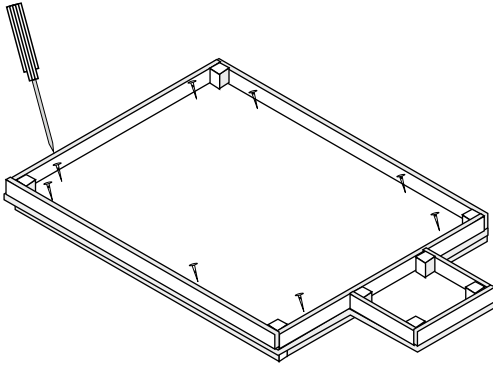

4A. To strengthen the assembly:

Before the glue is completely dry, turn the foundation upside down. Drill pilot holes and insert small wood screws or nail the frame from the bottom side. Just put a couple of screws or nails in each section (avoiding any cutouts for doors if applicable.)

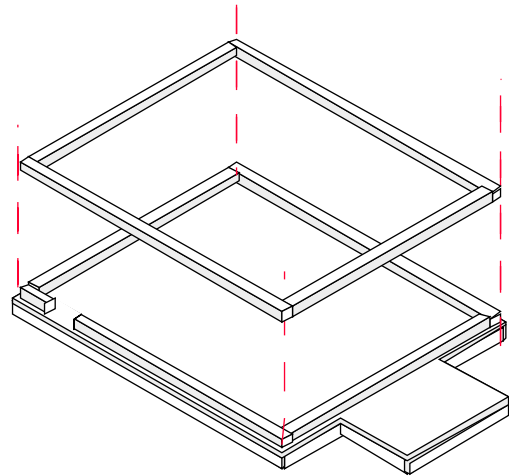
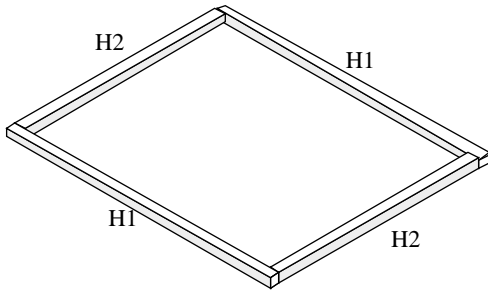

5. Top Frame Brace  
Again, using the diagram for building Frame for Walls, assemble the Top Frame Brace on a flat surface. Nail and glue, maintaining square corners.

6. Position the top frame brace directly over the bottom frame and check that they match vertically. Then lay the top aside.

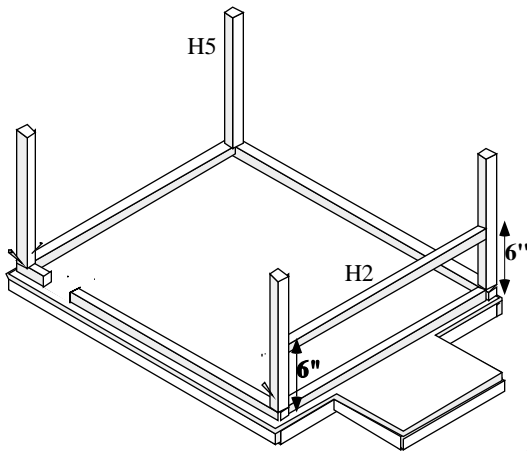

7. Vertical Studs.

You will need 1 stud on each corner. Glue and nail the studs in place. Nailing the studs will be easier if you drill a small pilot for the nail.

Mark 6" from foundation floor on the two corner studs next to the room addition. Position and nail horizontal brace (H2) inside the vertical studs. Top of the horizontal brace will be 6" Above foundation floor for addition .

**Note:**  
The opening in the frame is in case that you are using purchased opening doors. If your doors are non-opening doors, do not cut the frame.

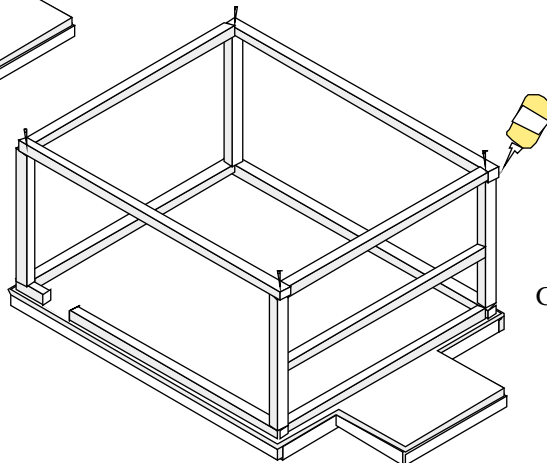

8. Add Top Brace  
Glue and nail the Top Brace onto the top of the Vertical Studs.

Walls

See Walls - Door and Window Placement of Openings.  
Cut out all walls including openings for windows and doors before church assembly.

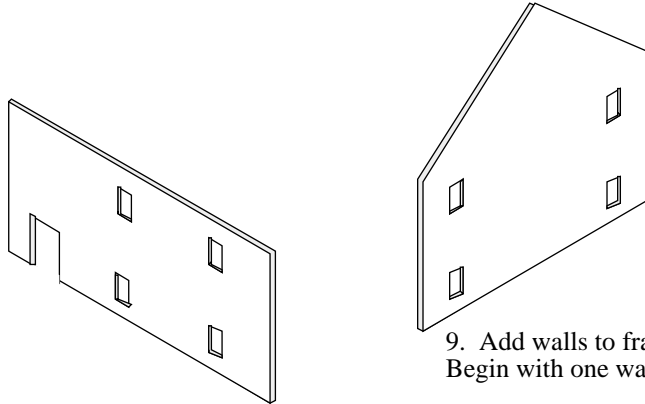

9. Add walls to frame  
Begin with one wall, glueing and nailing in place.

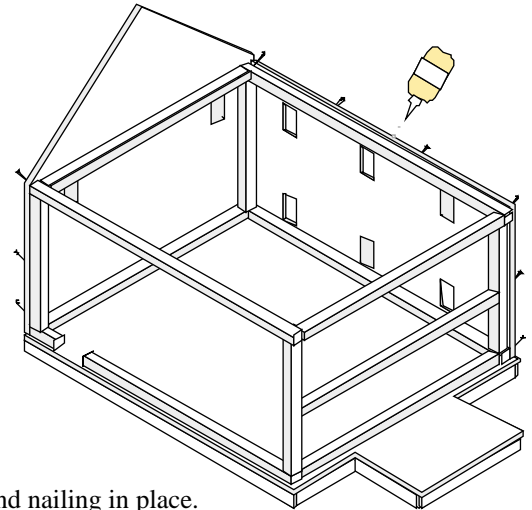

The side walls are assembled inside the end walls.  
Add adjacent walls, going in one direction. Be sure and secure the walls by nailing into the frame.

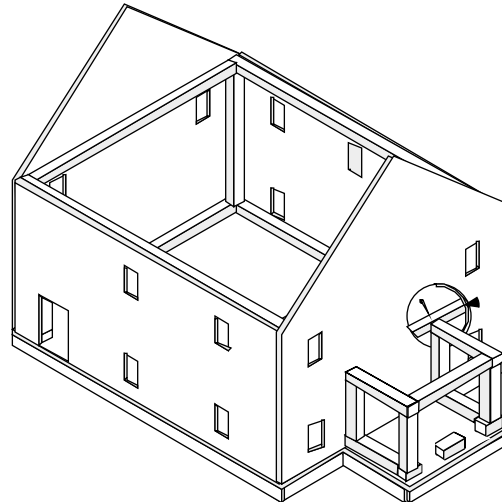
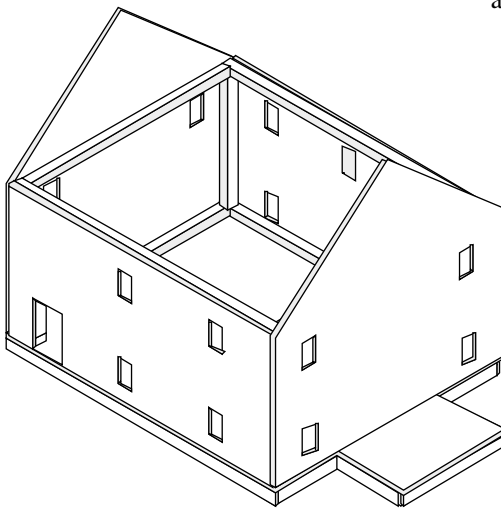

View for inside observation only.  
Don't cut a hole in your wall!

10. Continue assembling walls until all are in place. Check that all walls are secure and there are no "floppy" walls.

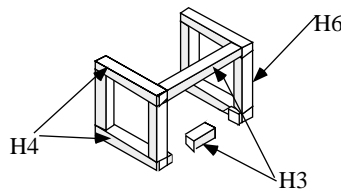
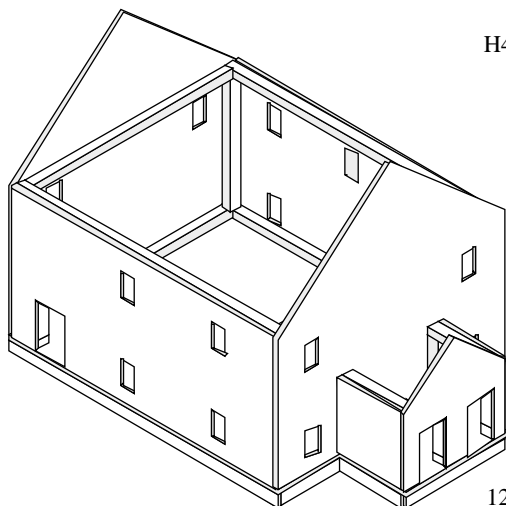

11. The Addition

Build the frame for the addition in the same manner as you used for the main building:

- Begin with securing bottom brace to foundation
- Assemble and check the top brace
- Add the vertical studs
- Secure the top brace to vertical studs.
- Secure the addition frame to the end wall: From the inside of the building end wall, nail through the horizontal inside (6" high) frame and the wall into the the addition frame top.

See the cut-away view.

12. Add the walls to the addition.

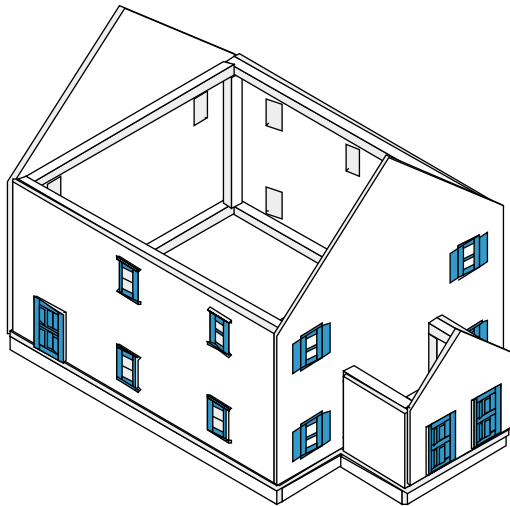

13. See Assembly - the Walls  
Install all doors and windows.

**Note: If you are adding lights to your church,  
use screws secure the roof.  
This will enable you to have access  
to the wiring and bulb.**

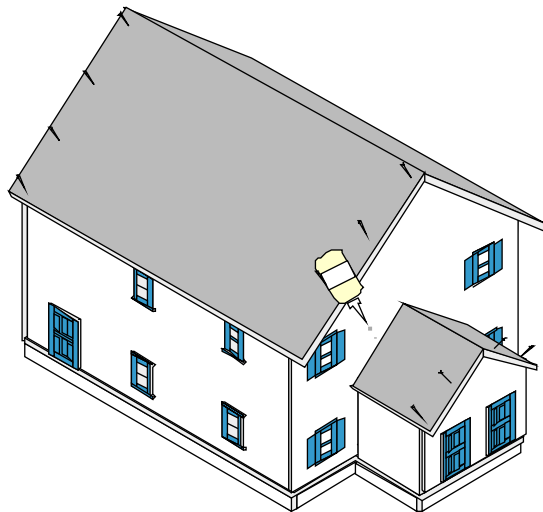
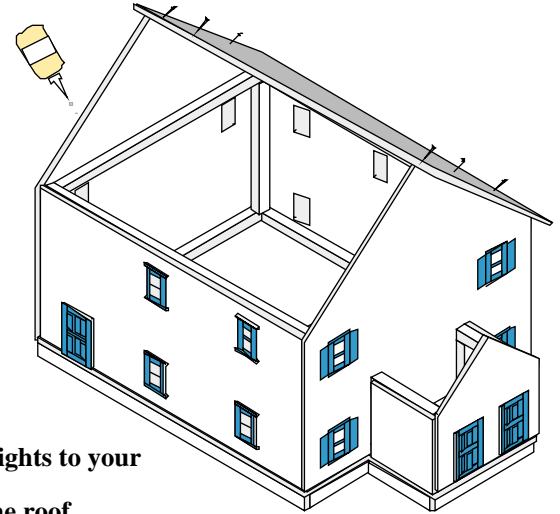

15.. Center and match the second half of the  
roof to the first half and the building.

Glue and nail in place.  
Using the same technique, attach the  
roof to the addition. Be sure and  
glue the back part which fits onto  
the church end wall.

14. Attach the roof.  
Run a bead of glue along the inside tops of the  
roof halves where the tops are mitered and  
will fit together. Also run a bead of glue  
around the exposed end wall tops where the roof  
will be attached. Carefully center and position one roof half  
in place . Nail along the top of the End Wall.

If you haven't mitered the roof  
halves, see Method 2 to  
assemble the roof on page 8

For joins which are  
not completely  
smooth, you can  
add a bead of  
caulking.

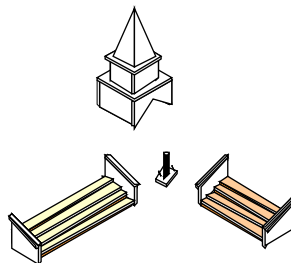

16. Build your church steeple,  
stairs and pipe according to  
their assembly instructions.  
Attach them to church with glue.

