

Scaled and easy to read patterns and instructions for a Water Tower made from wood, a 3 pound coffee can and a few sundry items.

Compatible with Garden Scale Railroads and Kiva's GardenTowns houses and buildings

Inspired by a model by Bill Mason

Overall Dimensions
Foundation: 8" x 8"

Height at peak:
approximately 16-3/4"

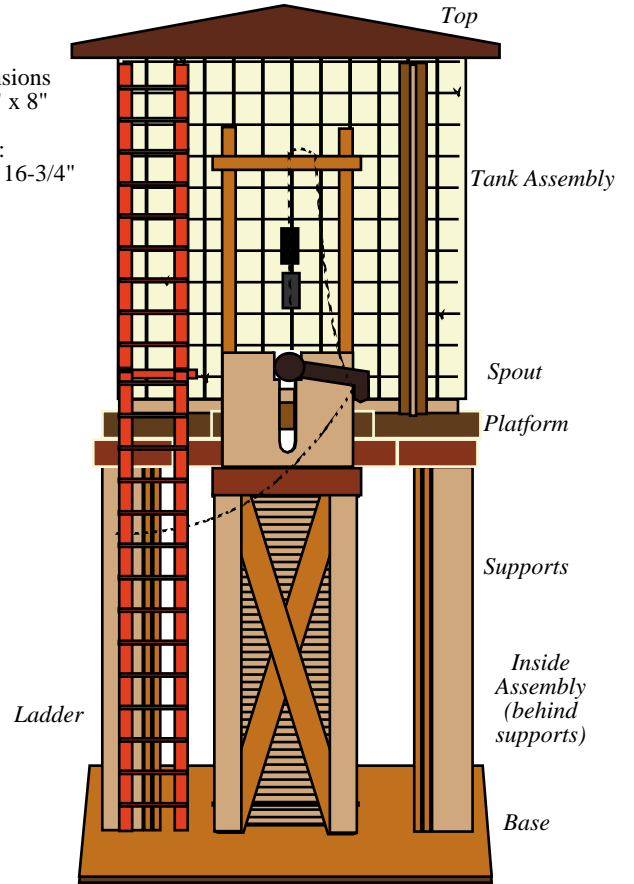
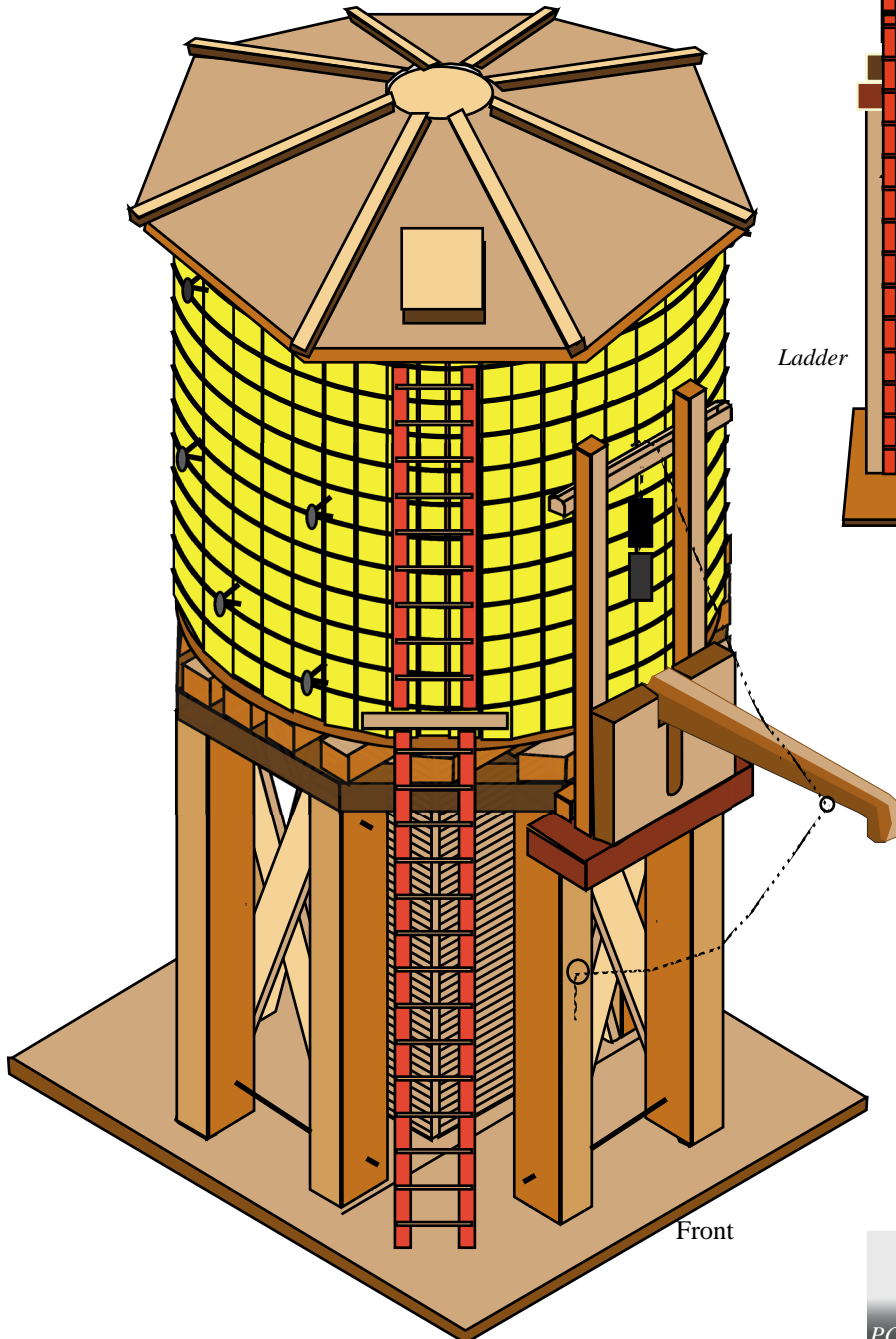

Tools Suggested

- Saw
- Hammer, Stapler or Air Gun
- Drill for pilot holes
- Screwdriver
- Ruler and Pencil
- Level
- Knife or blade to carve spout from soft wood

Supplies Needed

Hardware

- Approximately 14" chain with links small enough to fit through a 1/4" hole (screw eye) This can be a chain from some discarded costume jewelry or whatever you can come up with.
- Weights - 2 @ 1/2" dia x 1/4" long
See Page 10 for options on chain and weights

- 2 - 1/2" screw eyes
 - Wood Screws (flat head)
- | Qty. | Length |
|------|--------|
| 6 | 3/8" |
| 4 | 1-1/4" |

- Nails (Small head brads)
- | | |
|----|--------|
| 16 | 1/2" |
| 52 | 3/4" |
| 8 | 1-1/4" |
| 8 | 1-1/2" |

Sample: Suggested Hardware will be identified in assembly instructions with actual length



Table of Contents

Page

Tank Assembly	3
Platform Assembly for Tank - Patterns	4
Bottom of Platform (Actual Size)	5
Cross Braces for Platform (Actual Size)	6
Diagram for underneath placements (Actual Size)	7
Base	8
Support Assembly	9
Spout Assembly - Patterns and Spout	10
- Assembly	11
Channel / Inside Assembly	12
Ladder Assembly	13
Top - Patterns	14
Top - Assembly	15
Tower Assembly	16

Wire (Similar gauges can be substituted)

- 22 feet of 22 Gauge Galvanized wire for banding around the tank
- 2 feet of 16 Gauge wire to insert between the support posts

Other

- Wood Glue suitable for outdoors
- Sandpaper (fine)
- Paint or stain. We suggest the water based acrylic paints which can be found in a multitude of colors in arts and crafts stores.
- Sealer - polyurethane or water base varnish which can be found with acrylic paints. If you will display your water tower outside, keep in mind, the elements. You will need a very durable seal on the entire water tower.
- Wood putty

Wood Products are shown below.

- This is a ready reference of the parts you will be cutting. The bold figures will tell you how many feet or inches (rounded up) you will need.
 - 1/4" Plywood and 1/2" x 3/4" strips will most likely be found at the lumberyard.
 - You can buy strips of ready cut hardwood at hobby and craft stores.
- For the spout you'll more than likely want to use a soft wood (listed separately). This will be the only item to be carved. Hint: Balsa wood is easy to cut.

<p>Lumberyard</p> <p>1/4" Plywood - 24" x 18"</p> <table border="0"> <thead> <tr> <th>Squares</th> <th>Circles (radius)</th> </tr> </thead> <tbody> <tr> <td>1 @ 8-1/4"</td> <td>1 @ 6-1/2"</td> </tr> <tr> <td>1 @ 8"</td> <td>1 @ 6-7/16"</td> </tr> <tr> <td>1 @ 2"</td> <td>1 @ 6"</td> </tr> <tr> <td>1 @ 1"</td> <td>1 @ 5-5/16"</td> </tr> <tr> <td></td> <td>2 @ 2"</td> </tr> <tr> <td></td> <td>1 @ 1-3/8"</td> </tr> <tr> <td></td> <td>1 @ 1-1/4"</td> </tr> </tbody> </table>	Squares	Circles (radius)	1 @ 8-1/4"	1 @ 6-1/2"	1 @ 8"	1 @ 6-7/16"	1 @ 2"	1 @ 6"	1 @ 1"	1 @ 5-5/16"		2 @ 2"		1 @ 1-3/8"		1 @ 1-1/4"	<p>1/2 x 3/4" x 8 feet</p> <p>4 @ 2-13/16" 1 @ 2-3/4" 2 @ 3" 8 @ 6-3/4" 2 @ 7" Total 88"</p>	<p>1/8 x 1/2" x 27 feet</p> <p>39 @ 6-5/8" 8 @ 7-1/4" Total 317"</p>
	Squares	Circles (radius)																
1 @ 8-1/4"	1 @ 6-1/2"																	
1 @ 8"	1 @ 6-7/16"																	
1 @ 2"	1 @ 6"																	
1 @ 1"	1 @ 5-5/16"																	
	2 @ 2"																	
	1 @ 1-3/8"																	
	1 @ 1-1/4"																	
<p>Hobby Store</p> <p>1/16" square x 3 feet</p> <p>23 @ 1-1/4" Total 29"</p> <p>1/8" x 4" x 18" Grooved Siding or Plain Hardwood See Page 12</p> <p>2 @ 1-1/2" x 1-3/4" 4 @ 1-3/4" x 6-3/4" Total 16"</p> <p>1/8 x 1/4" x 3 foot</p> <p>8 @ 3-3/8" Total 28"</p>	<p>1/4" square x 4 feet</p> <p>1 @ 2" 1 @ 2-3/8" 1 @ 2-3/4" 2 @ 5-5/8" 2 @ 6-1/4" 2 @ 8-1/2" Total 48"</p> <p>1/4" x 1/2" x 7" Grooved or plain</p> <p>1 @ 6-5/8"</p> <p>1/2" square x 4 feet</p> <p>2 @ 4" 2 @ 6" 4 @ 7" Total 48"</p> <p>1/2" square x 4" Soft wood</p> <p>1 @ 4" for carving spout</p>																	

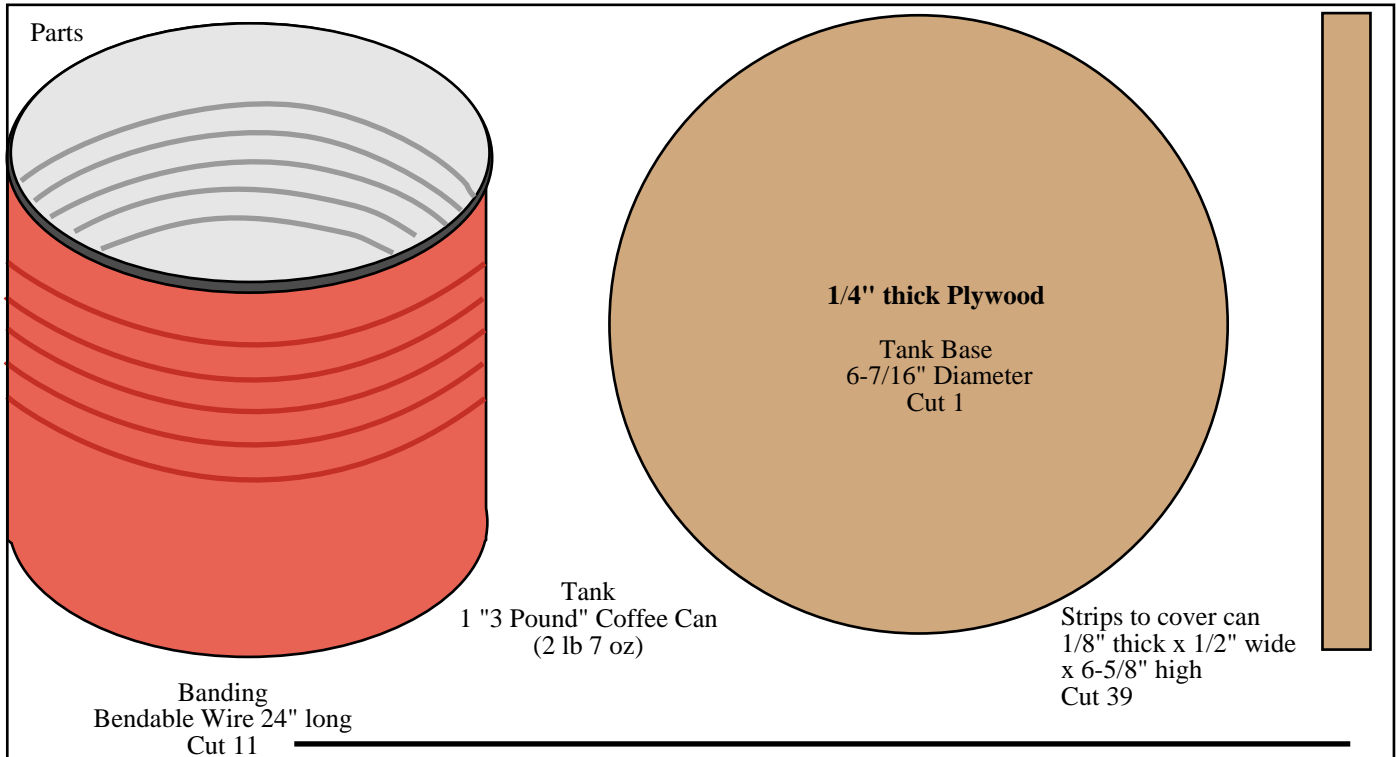

Assembly



1. Center and glue the tank can to the tank base. There will be a 1/8" ledge around the tank.

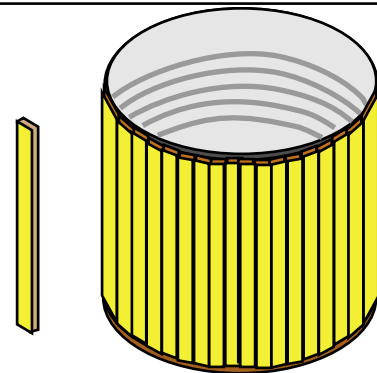

2. Rest the bottoms of the slats on the ledge of the base and glue slats to the outside of the tank.

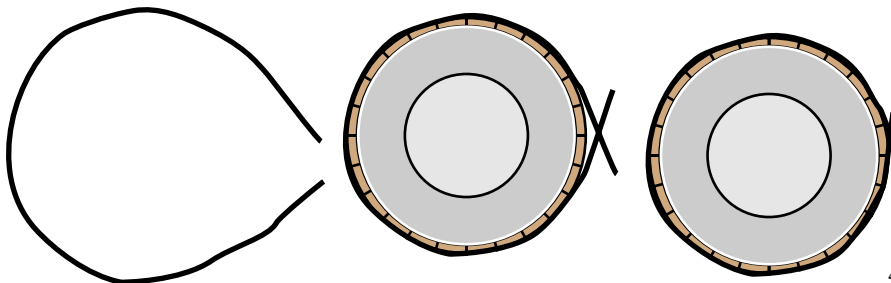

3. Wrap wire securely around tank and twist the ends with pliers to hold in place. When secure, clip off the wire ends with wire cutters.

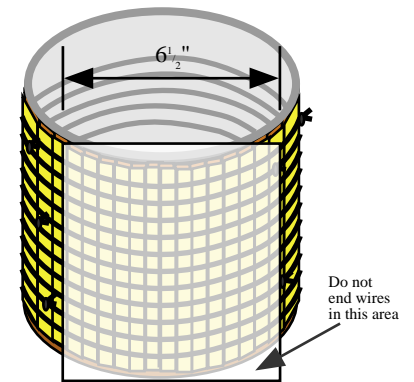

4. Continue, adding all wires, using a random pattern for closing. The wires do not have to be totally straight horizontally. Leave one vertical area about 6 1/2" across free of the wire ends to simplify attaching the spout assembly, ladder, and channel.

Parts

Platform bottom

Cut from 1/2 x 3/4" Molding



Do not trim A

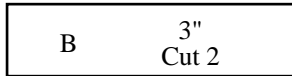

Do not trim B

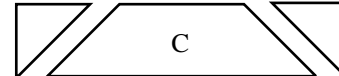
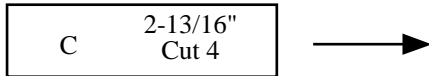

Platform Cross Braces

Cut from 1/2" x 1/2" Square



Do not trim D

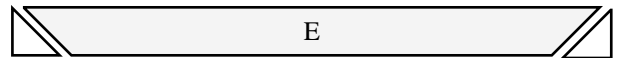

Assembly

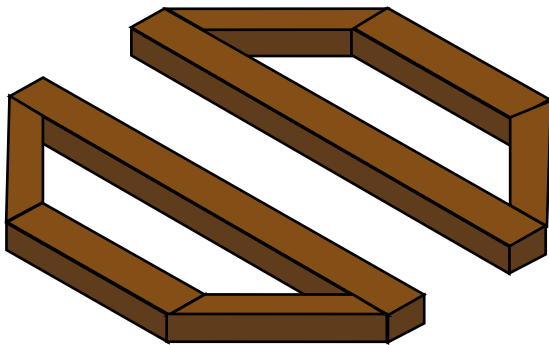

Platform bottom

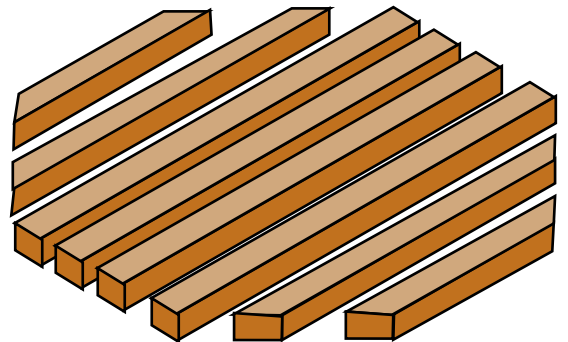

Platform Cross Braces

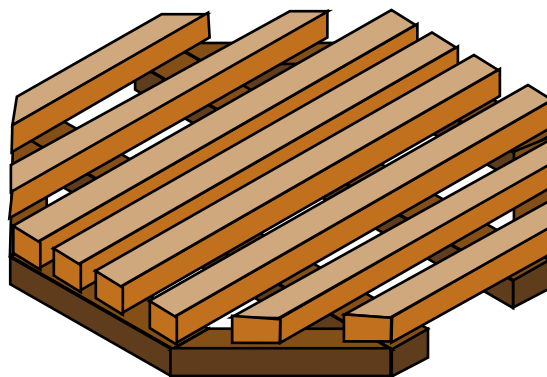

Cross Braces will rest upon the assembled bottom.

Tank will sit on the cross braces

The tank platform bottom consists of two sides placed 1-1/2" apart in mirror image, as shown in this top view of actual size illustration.

Assemble the pieces as shown and separately nail and glue each side together.

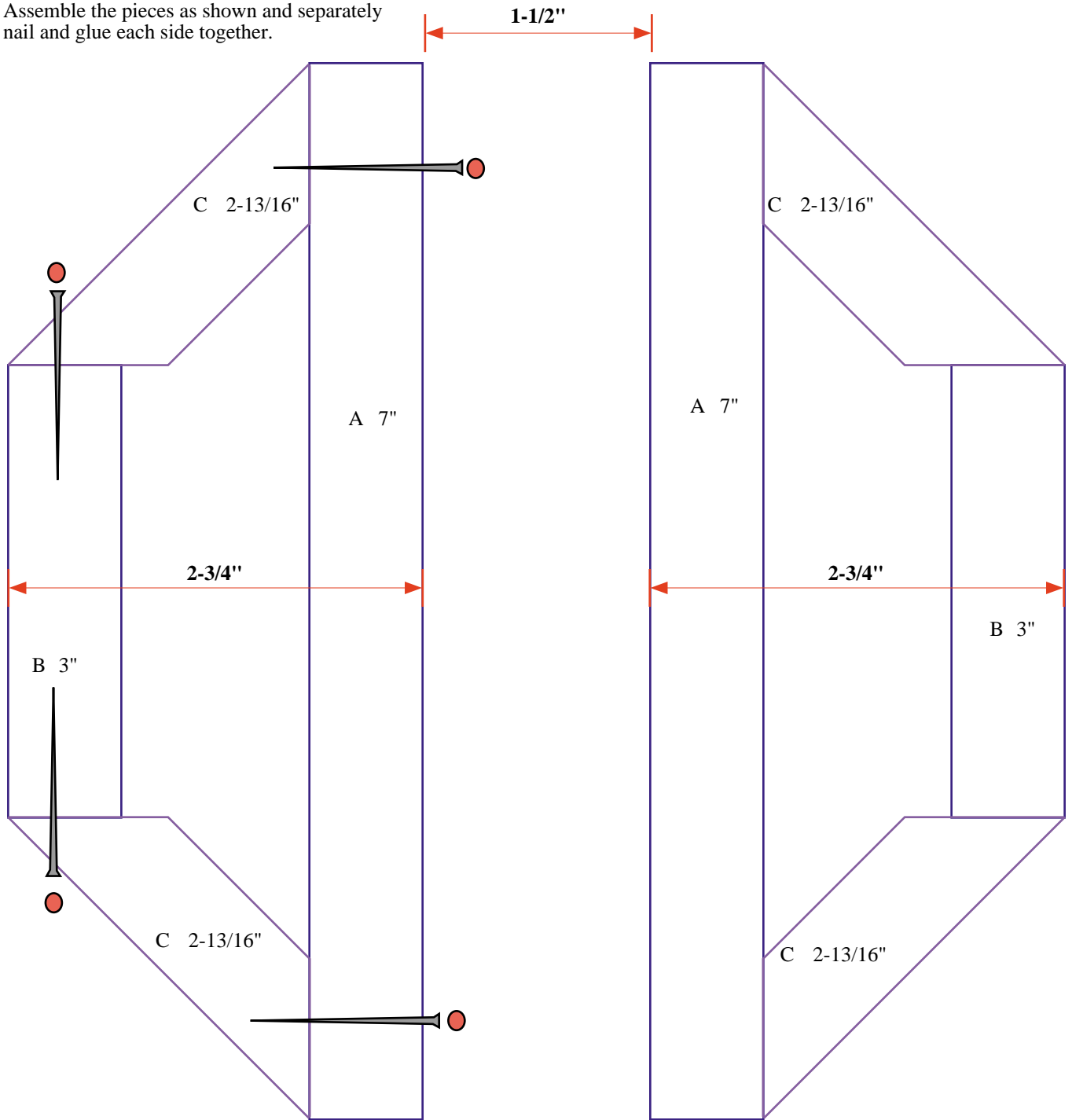

Front of Water Tower

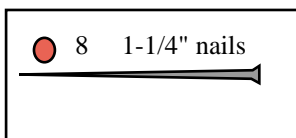

Glue and nail cross braces to the tank platform bottom assemblies, as shown in the actual size illustration below.

The circle marks where the tank will be placed.

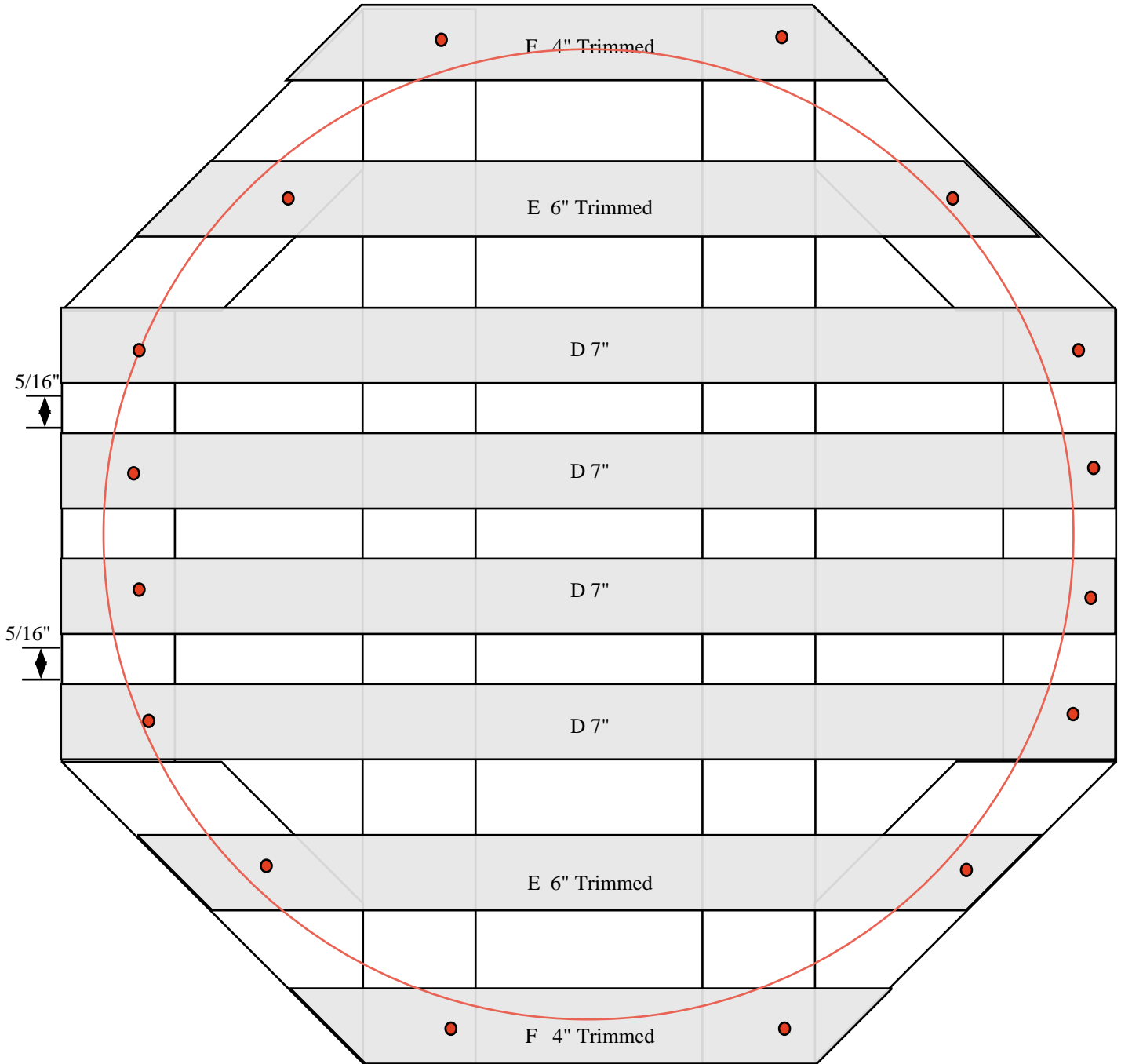
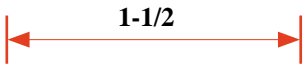

Front of Water Tower

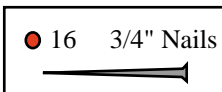

Actual sized diagram for placements
of completed Supports, Center,
Ladder and Spout Support

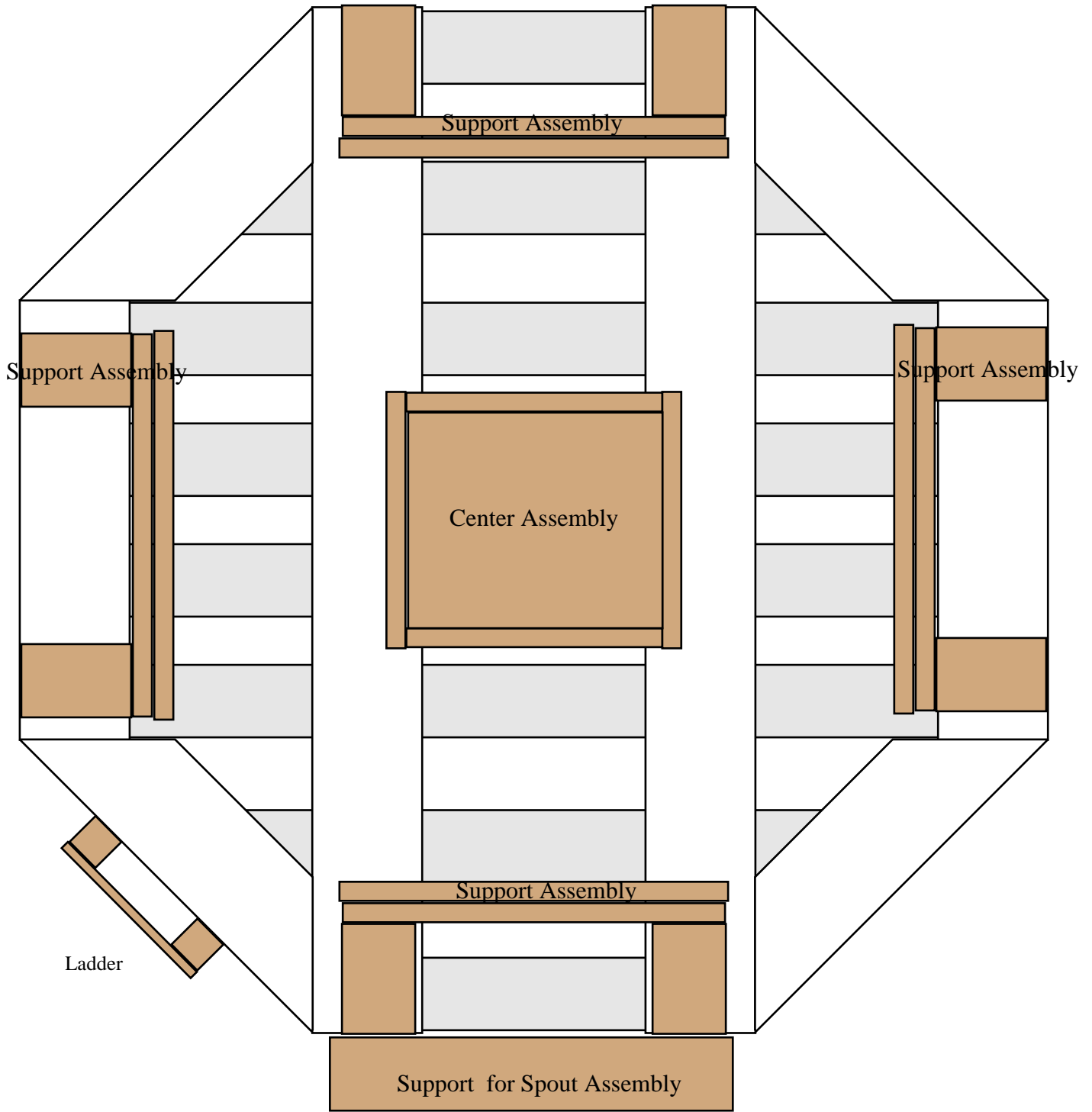

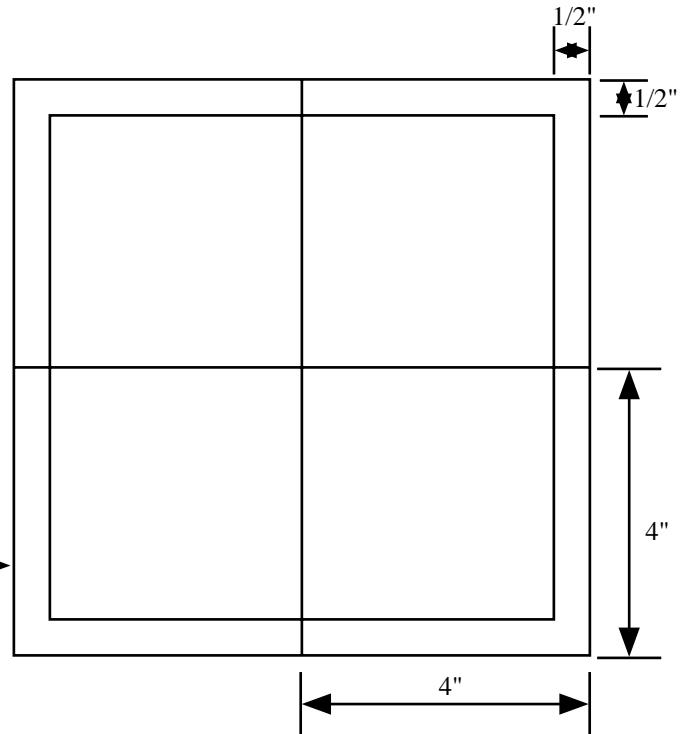
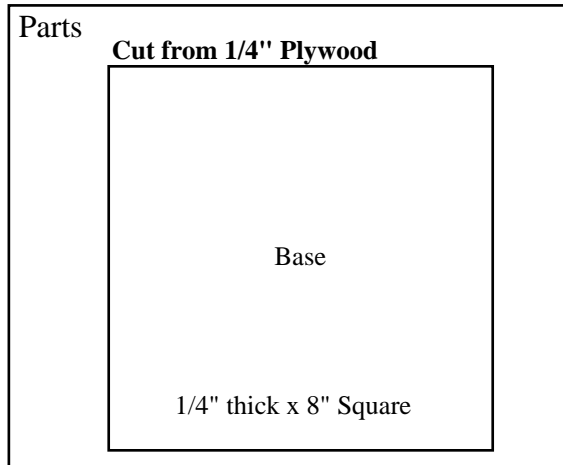

Instructions

1. Using a ruler and pencil, measure and mark the following:

- Center of the base (4" from each corner)
- 1/2" from each side, to form a 7" square.

2. Inside the 7" square, measure and mark the following measurements:

*2- 3/16" from each corner both vertically and horizontally

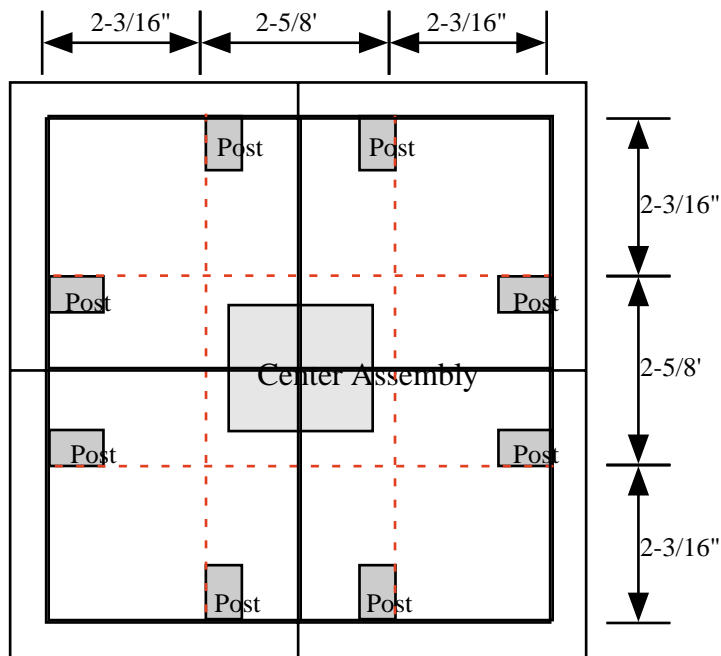

This will be your guide for post and center assembly placements.

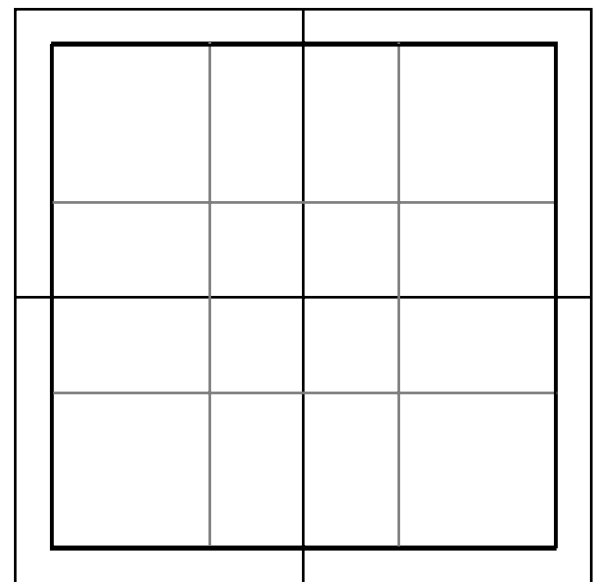

Measured base will look like this

Parts

A
Support
1/2" thick x 3/4" wide
6-3/4" high
Cut 8

B
Cross Brace
1/8" thick x 1/2" wide
7-1/4" high
Cut 8

C
Straight firm wire
2-3/4" long
Cut 8

Assembly

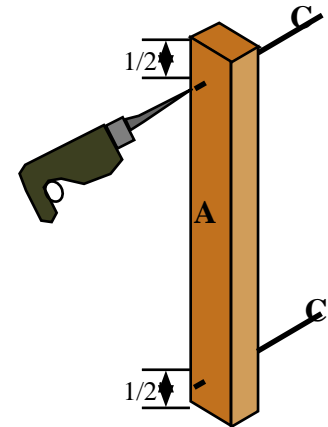
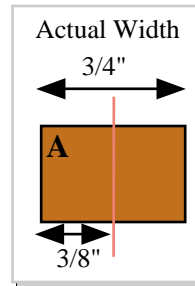

1. To install the wires, drill two holes through the 1/2" depth of Support A. Center the holes on the 3/4" side (at 3/8" center) and 1/2" from tops and bottoms.

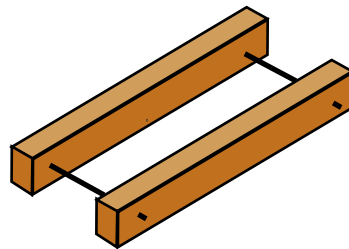
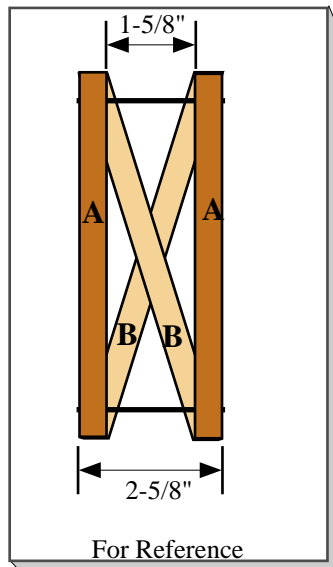

2. Install the wires, pushing clear through both supports. Adjust the space between the two posts to 1-5/8".

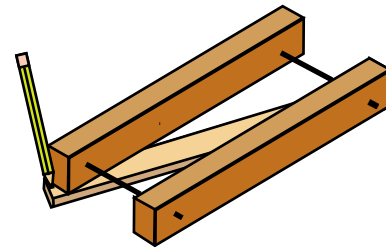

3. Lay the supports flat. Slip a cross brace underneath so that the tops and bottoms of the opposite support posts are covered. You will need to make the posts and cross braces flush on each end. Pencil a line across the post onto the crossbrace to mark your cutting line.

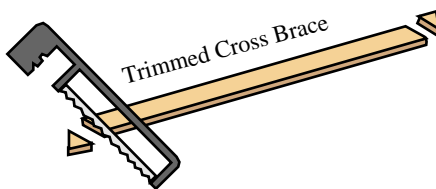

4. Cut off the ends of the cross brace on the pencil lines. You can use this piece as a pilot pattern for the rest of the cross braces.

5. Lay your trimmed support on top of each of the other 7 cross braces. Mark and trim the ends of each brace. They will all be alike.

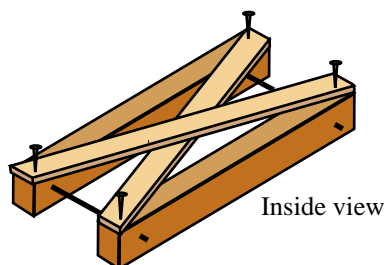

6. Glue and nail the Cross Braces in place.

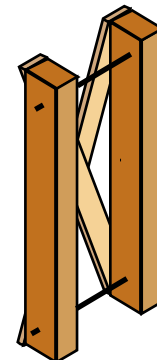
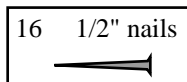

Outside view of Support Assembly

Parts

A
Sides
1/4" square
x 6-1/4" long
Cut 2

B
Chain Holder
1/4" Square
x 2-3/4" long
Cut 1

C
Bottom Brace
1/2" x 3/4"
x 2-3/4" long
Cut 1

D
1/4" thick
2" x 2"
Cut 1
Use template
to cut out center

E
Spout
Carve 1 from
1/2" Square x 4" Soft wood
(can use Balsa)

F
Back Brace
1/4" Square
x 2" long
Cut 1

G. Chain: Small chain, somewhere in the area of 14 inches. We used a discarded chain from some costume jewelry. You could also substitute chain with string, representing rope. Either will need to fit through a 1/4" hole (screw eye).

H. Weights
See below

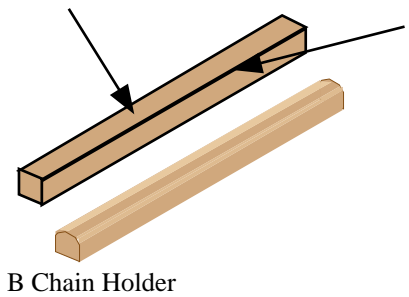

With sand paper, round off the top of the 1/4" squared piece (so the chain can move over it smoothly)

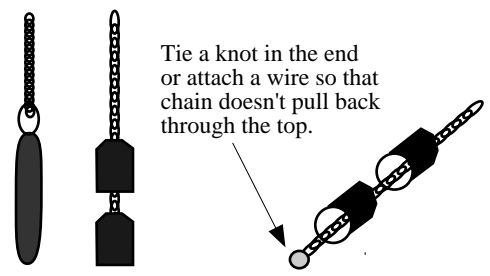

Weights:
There are a number of items you can use to represent the weights. You can most likely find something suitable around the workshop. Each can't be much larger than 1/2" long x 1/4" wide. We took a couple of valve caps, punched holes in the tops and threaded the chain through. Then we filled the cavities with wood putty and painted it black.

- Use a single, longer weight if you wish (approx. 1" long).
- You could also make weights from polymer clay (found in hobby stores), which bakes in the oven. Punch holes in the weights before you bake them.

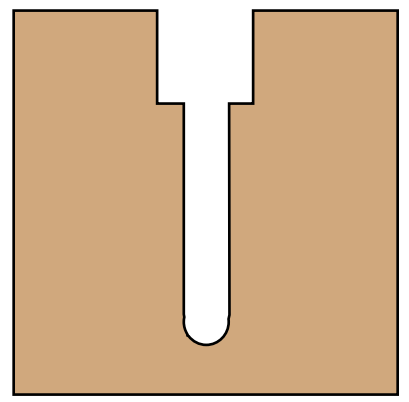

D - Actual Size use as template or mark your measurements and cut out center

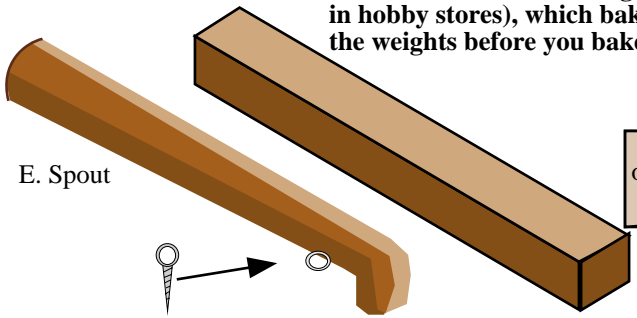

Attach a small screw eye to one side of the spout.

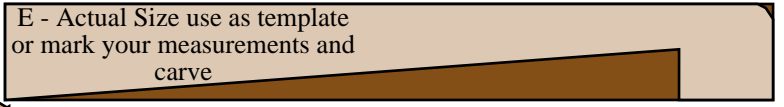

You can carve your spout from any soft wood, including Balsa, which is easy to cut. The straight end will fit into the top of the slot on part D.

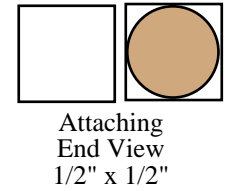

Assembly

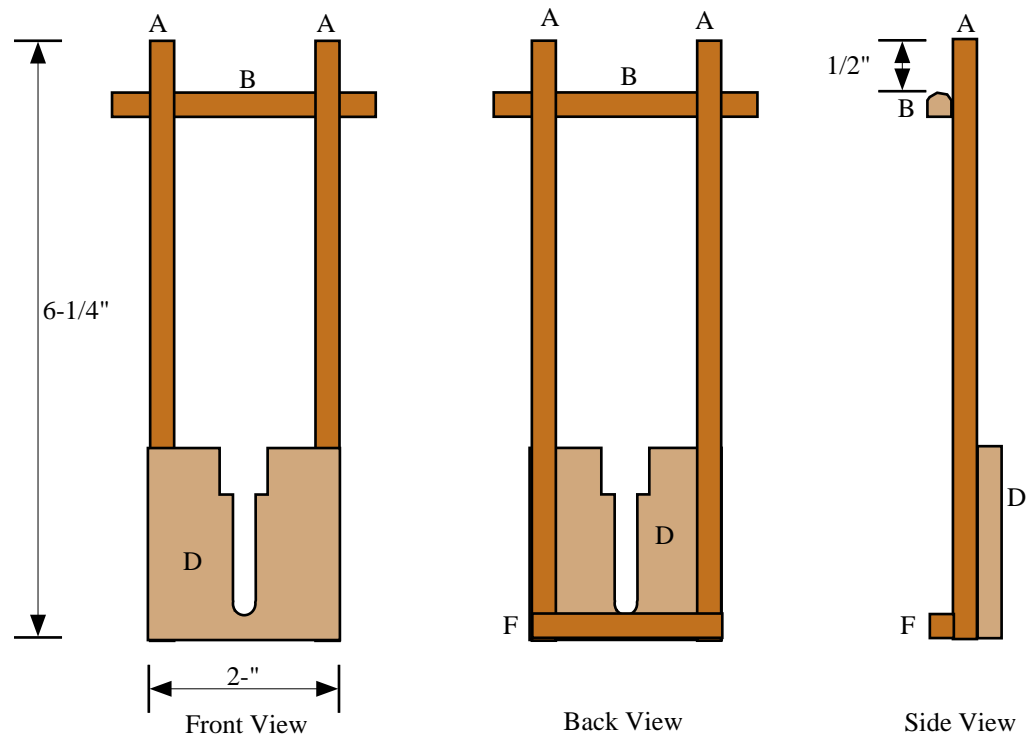

1. Assemble and glue parts, as shown in the diagrams.

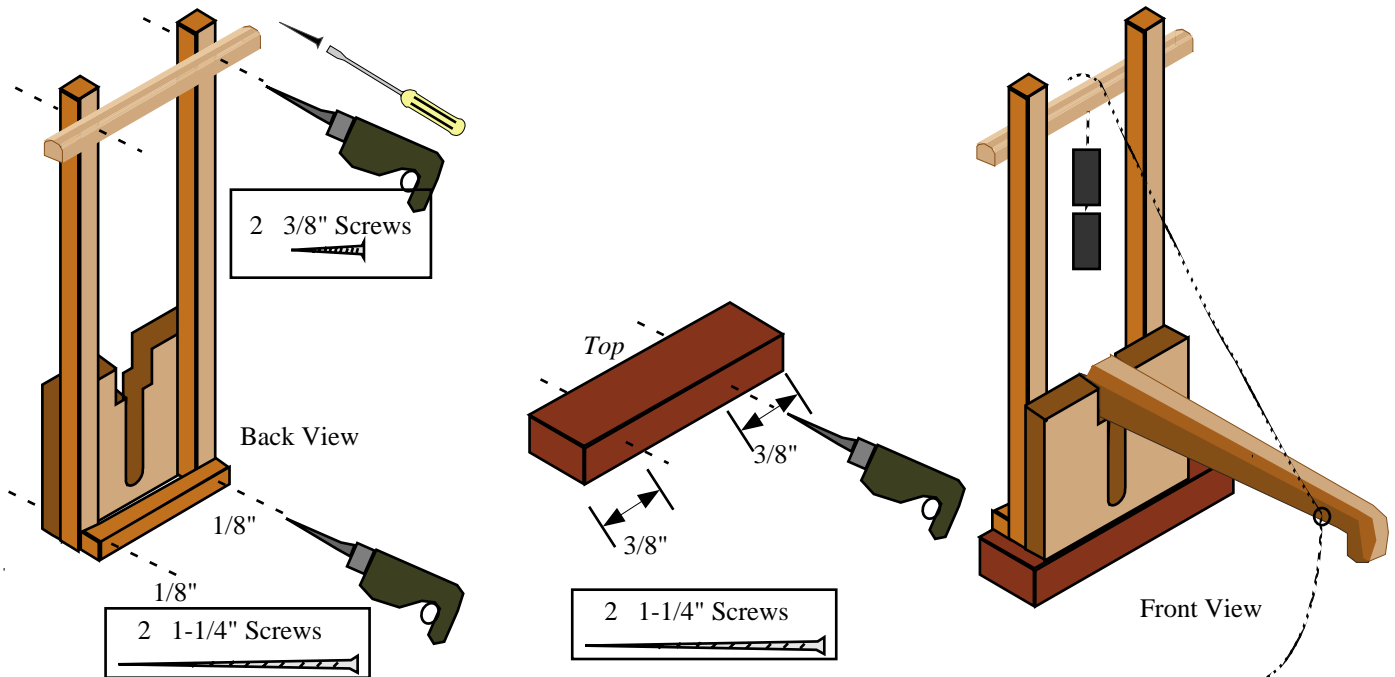

2. From the back :

- Drill small pilot holes through the sides and the chain holder. Use small 3/8" screws and secure the chain holder to the sides.

- Drill small pilot holes through the back brace, sides and spout holder at 1/8" from the edges. The bottom holes will be for securing the assembly to the platform later.

3. Part C Bottom Brace

Drill two small pilot holes through the 1/2" side. These holes will be used for screws when attaching to the support posts later.

4. Glue the spout in place inside the top groove of the spout holder.

The chain and weights will be installed as shown. Chain will be run through the eye on the spout and back to another eye which will be attached to the support post later.

Parts

Channel

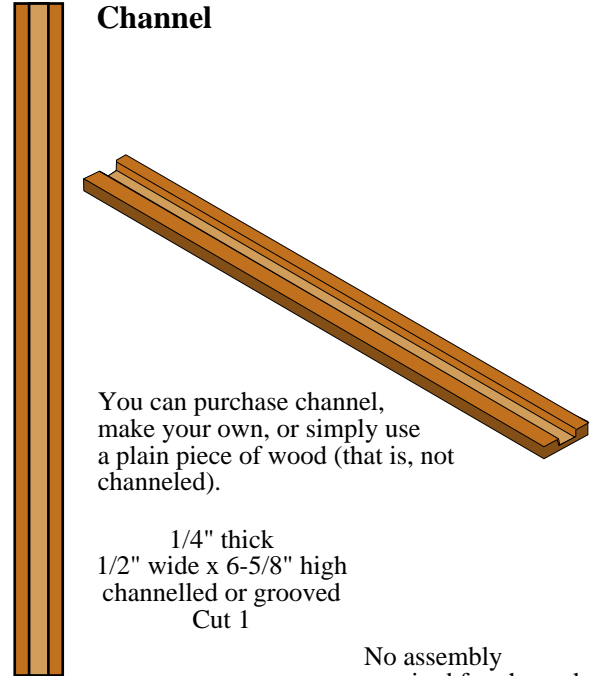

You can purchase channel, make your own, or simply use a plain piece of wood (that is, not channelled).

1/4" thick
1/2" wide x 6-5/8" high
channelled or grooved
Cut 1

No assembly required for channel

Inside Assembly

1/8" thick wood

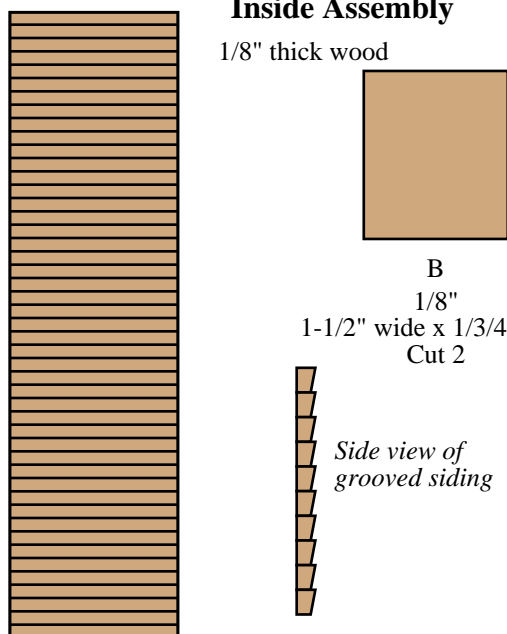

A
1/8"
1-3/4" wide x 6-3/4" high
Cut 4

B
1/8"
1-1/2" wide x 1/3/4" high
Cut 2

Side view of grooved siding

You can use grooved siding, as found in hobby stores, or just use a smooth finish wood.

Inside Assembly

Assembly

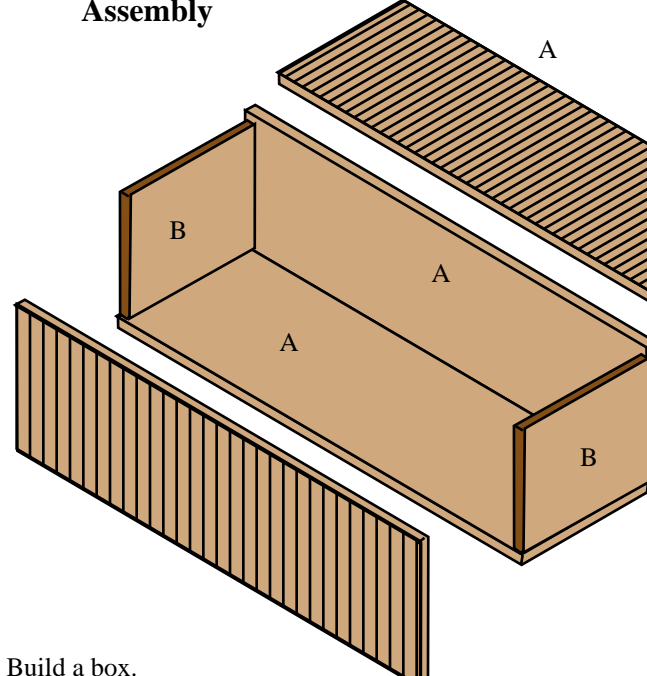

Build a box.
Glue together with the end pieces assembled on the inside of the sides to hold the sides in place.

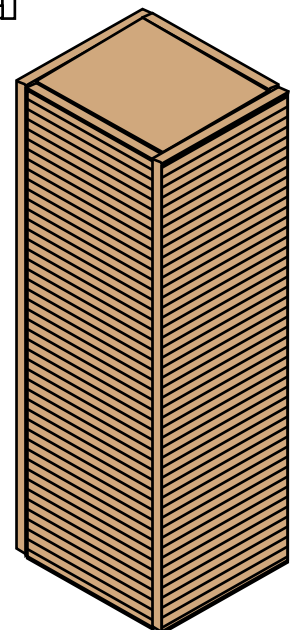
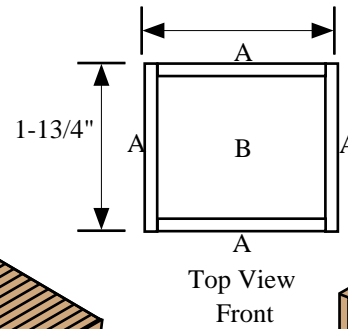

Finished assembly will stand on end underneath the center of the tank and platform.

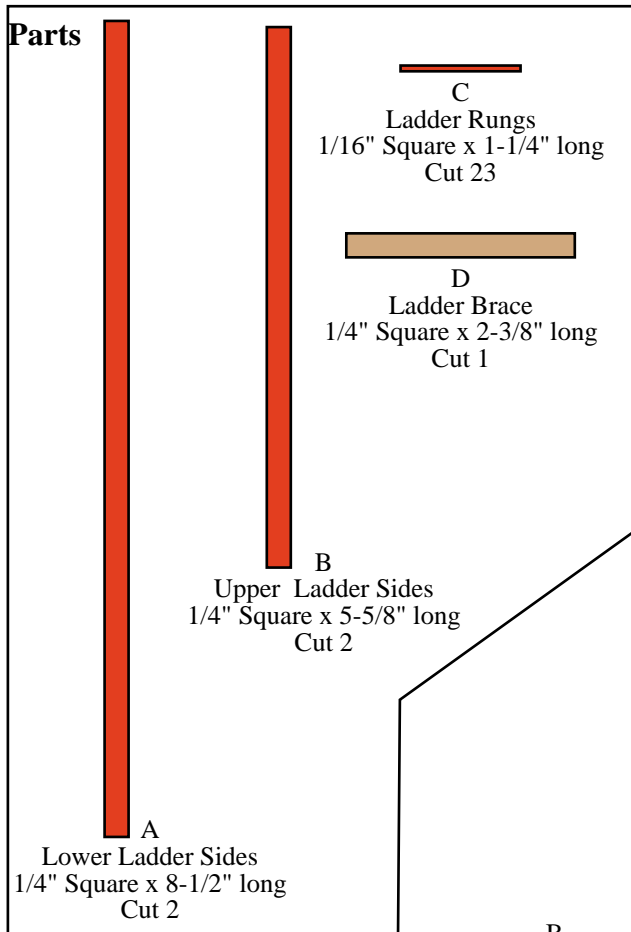

Assembly

Illustrations are actual size.
 Use as guide for rung placements.

Place the sides at 1-1/4" apart and secure so that they don't shift.
 Glue rungs in place and allow to dry completely before trying to move.

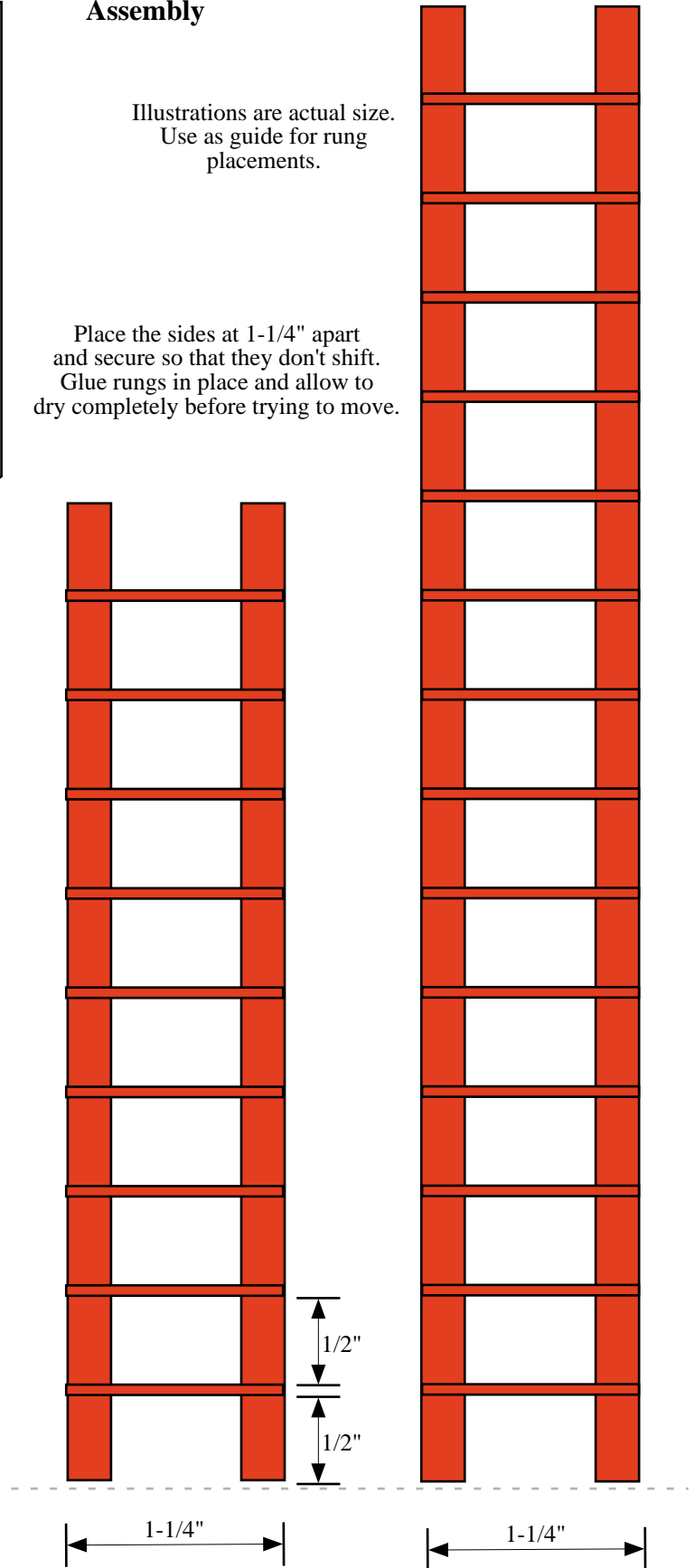

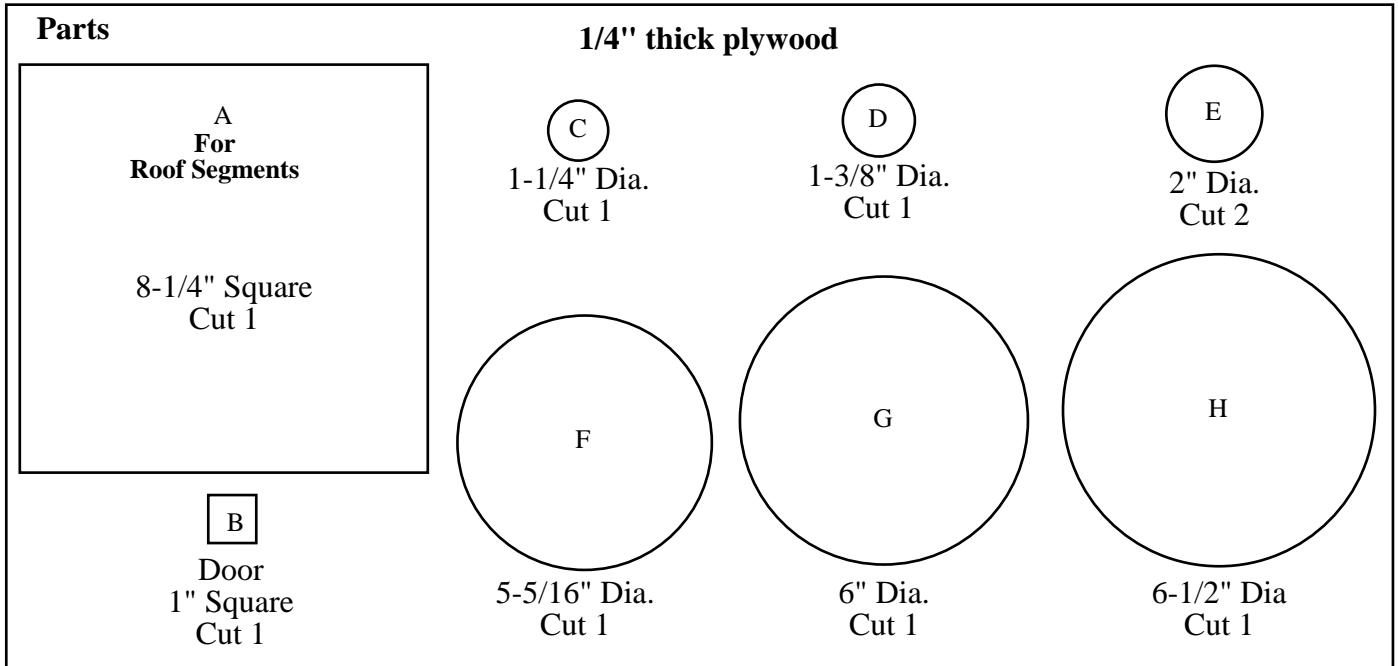

Assembly From Part A, Make the Roof Segments

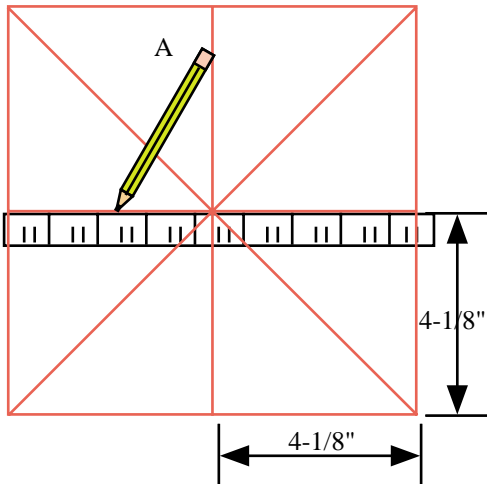

1. Using ruler and pencil, measure and mark centers and corner to corner, as shown.

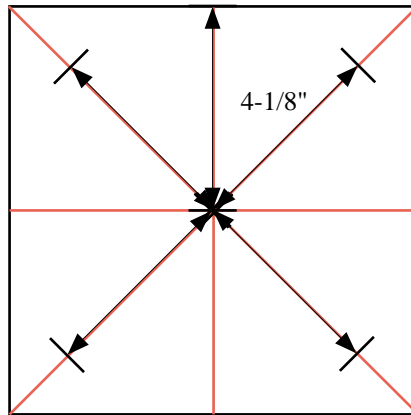

2. From the center, measure and mark 4-1/8" on each of the diagonal lines. (Horizontal and vertical lines are automatically 4-1/8" long).

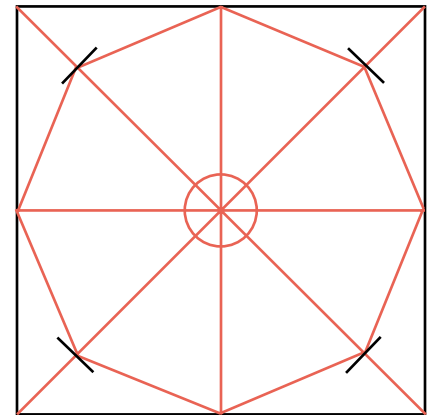

3. Use your ruler and connect the lines at the 4-1/8" measurements, to form an octagon.
4. In the very center, draw a 1-1/4" diameter circle.

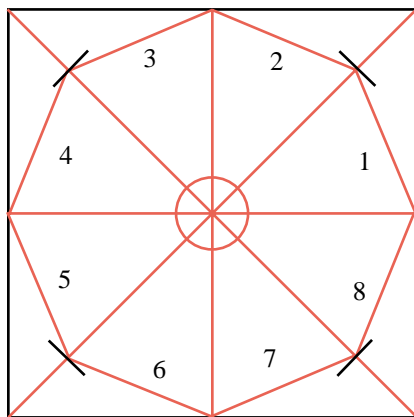

5. With pencil, number the segments in sequence prior to cutting out.

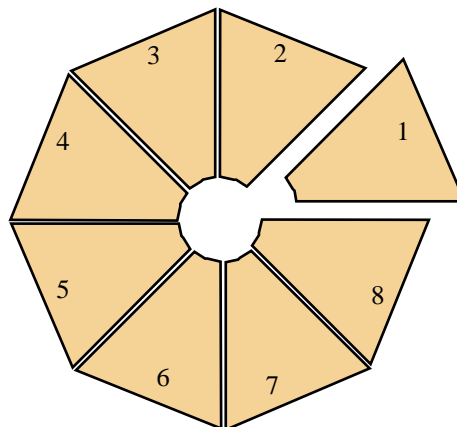

6. Cut out all segments on the measured lines, including the circle line.

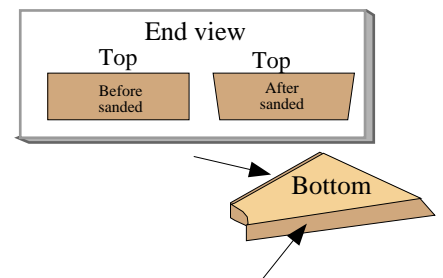

7. To help ease the pieces back together, sand the sides of each segment. Just smooth out the top and sand off a bit of the sides towards the bottom side.

Parts



Top Finishing Strip
1/8" x 1/4" x 3-3/8"
Cut 8

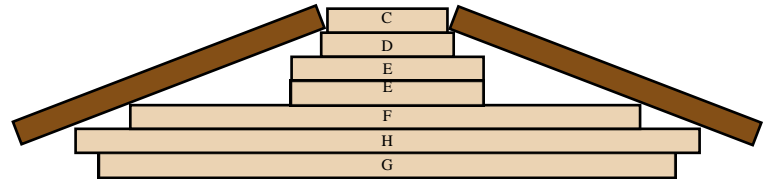

Cut-away side view of finished roof

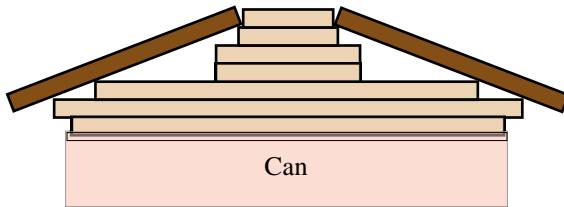

Bottom circle of lid will fit inside the coffee can

- C 1-1/4"
- D 1-3/8"
- E 2"
- E 2"
- F 5-5/16"
- H 6-1/2"
- G 6"

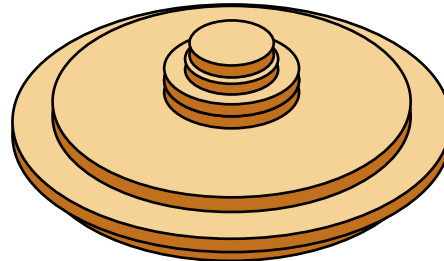

- Center and glue all the circles C through H in the order shown in above cut-away view. Part D will form a ledge on which to rest the tops of the roof segments.

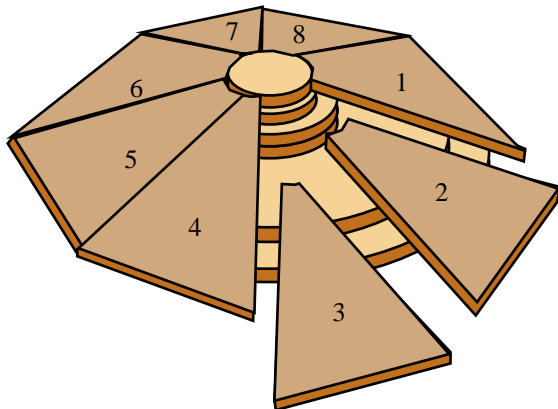

- Going in one direction or the other, place the top segments onto the base. Use the same sequence as you cut them out. The top of each segment will rest on the ledge. Make sure that the pieces will fit together before securing. You may want to tape them together with masking tape to check fitment. If needed, do a little more sanding so that the edges fit as well as possible. They do not need to be "perfect", as the seams will be covered but they should lie down smoothly.

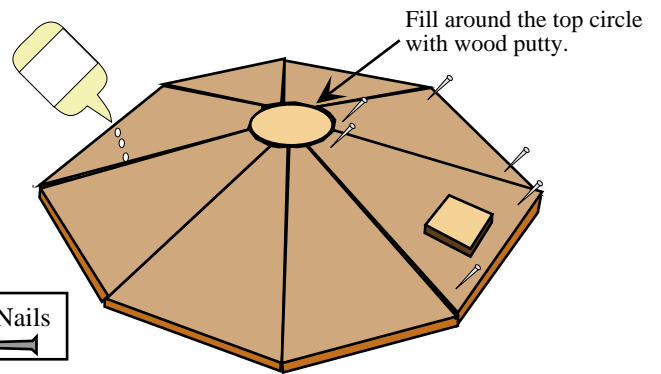

24 3/4" Nails

- Glue the segments onto the base. You can add some small brads to strengthen the assembly. Countersink and fill the holes. The segments will be fairly flush with the top circle. Fill spaces around the circle with wood putty.
- Glue the door in place. (The door will be directly above the ladder when assembly is complete)

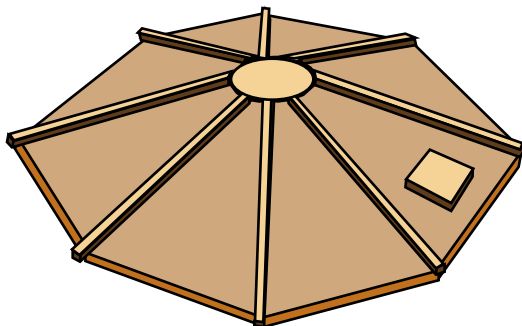

- Center a finishing strip over each segment seam and glue in place.

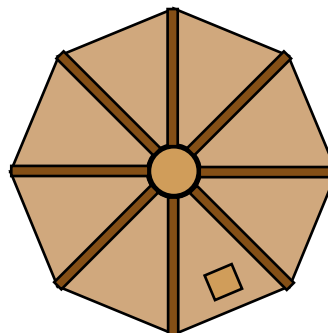

Top view of lid

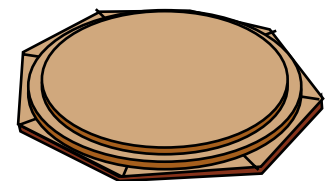

Bottom view of lid

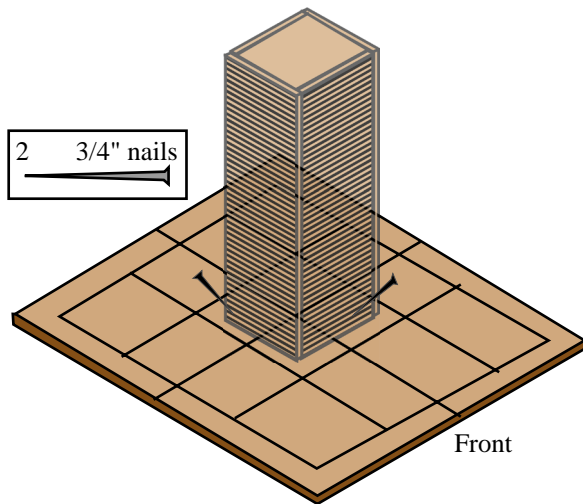

1. Using your guide lines marked on the base, center the Center Assembly. Nail and glue in place to the base. The 2" side of the Center Assembly will be the front and back of the water tower.

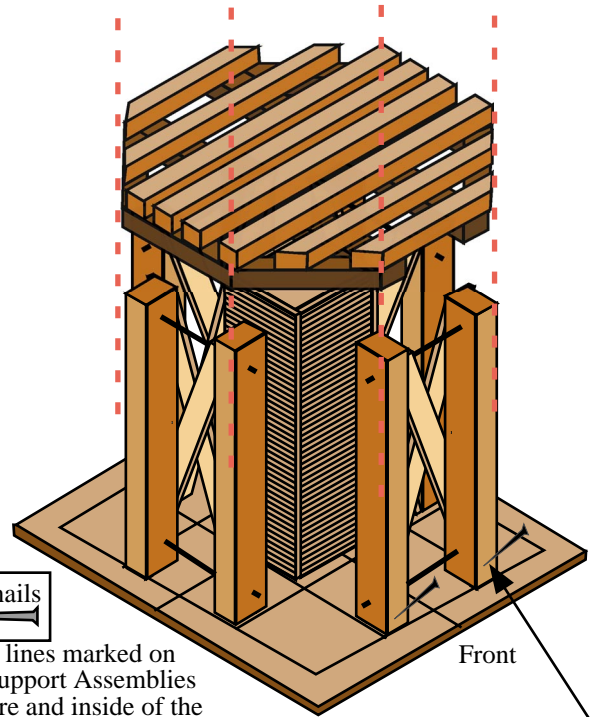

2. Using your guide lines marked on the base, place the Support Assemblies inside of the 7" square and inside of the two post guide lines. Before you secure, check that the Platform Assembly fits directly over the Supports, as planned.

Drill pilot holes in the posts. Glue and nail them to the base.

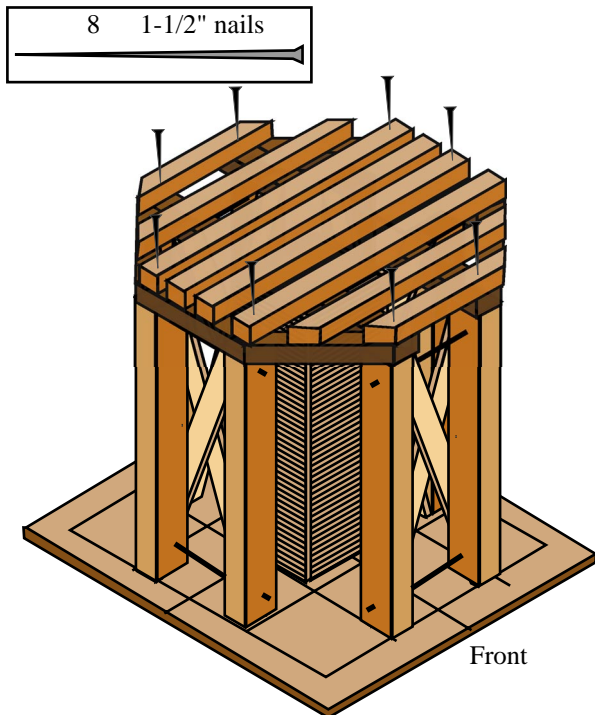

3. Use nails or screws and glue the Platform Assembly in place over the support post.

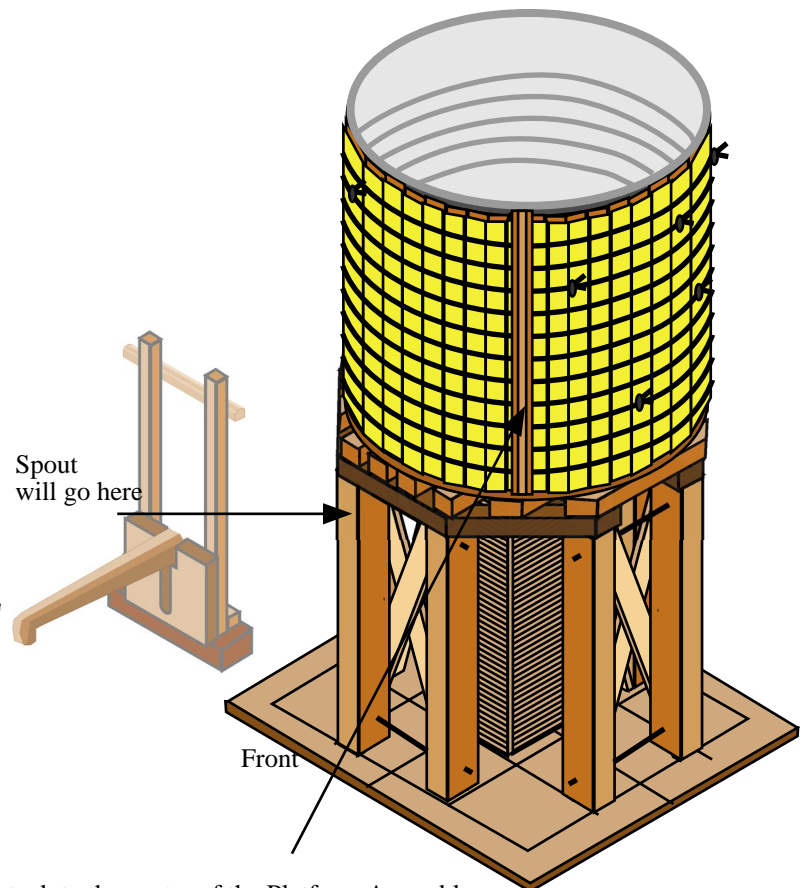

Glue the tank to the center of the Platform Assembly. Glue the Channel to the tank, as shown.

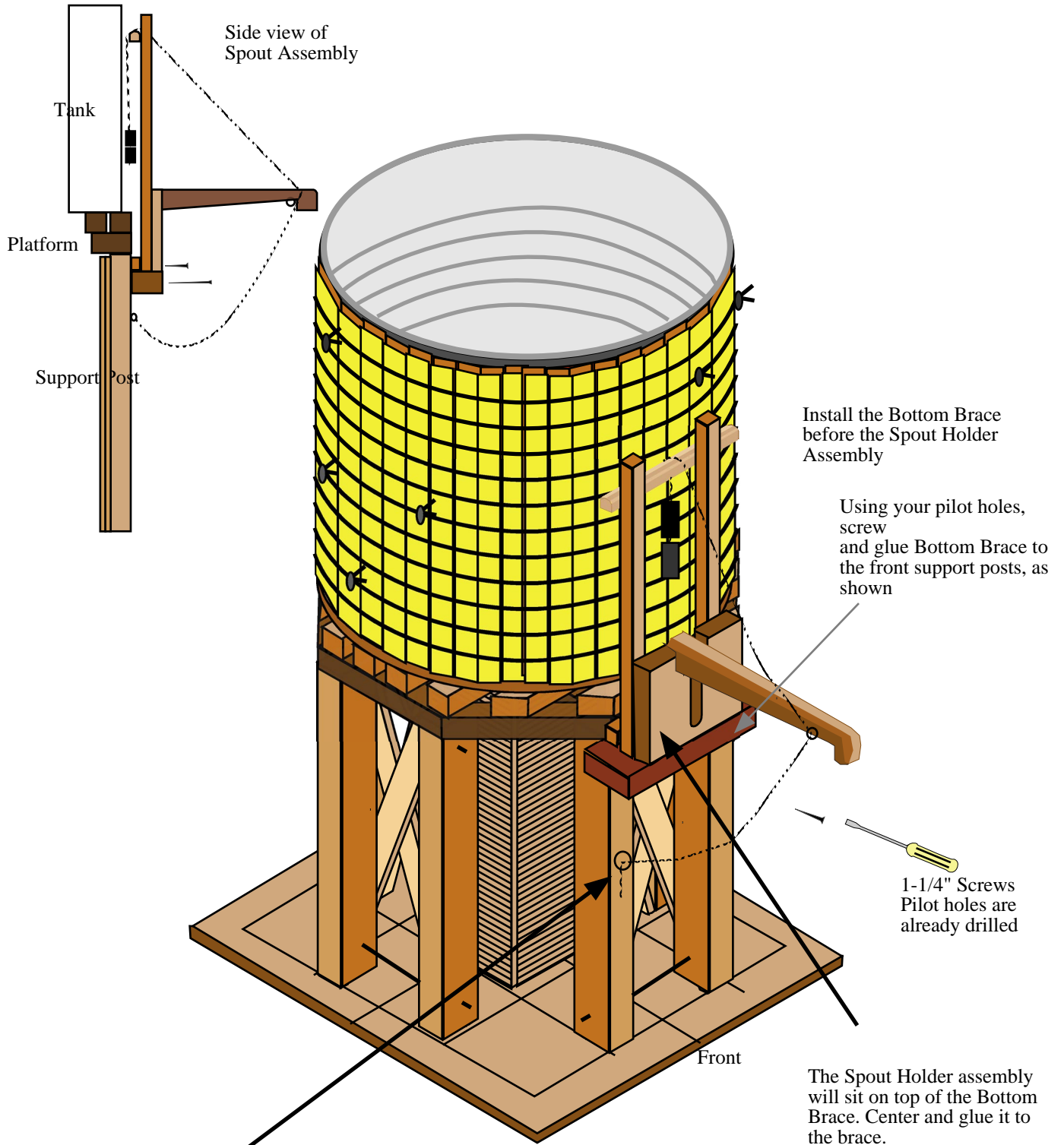

Arrange the chain to your satisfaction and screw a small screw eye into the support post. Run the end of the chain through the eye and secure with a wire.

The Spout Holder assembly will sit on top of the Bottom Brace. Center and glue it to the brace. Using your pilot holes in the spout holder, screw and glue the entire spout assembly to the platform behind it.

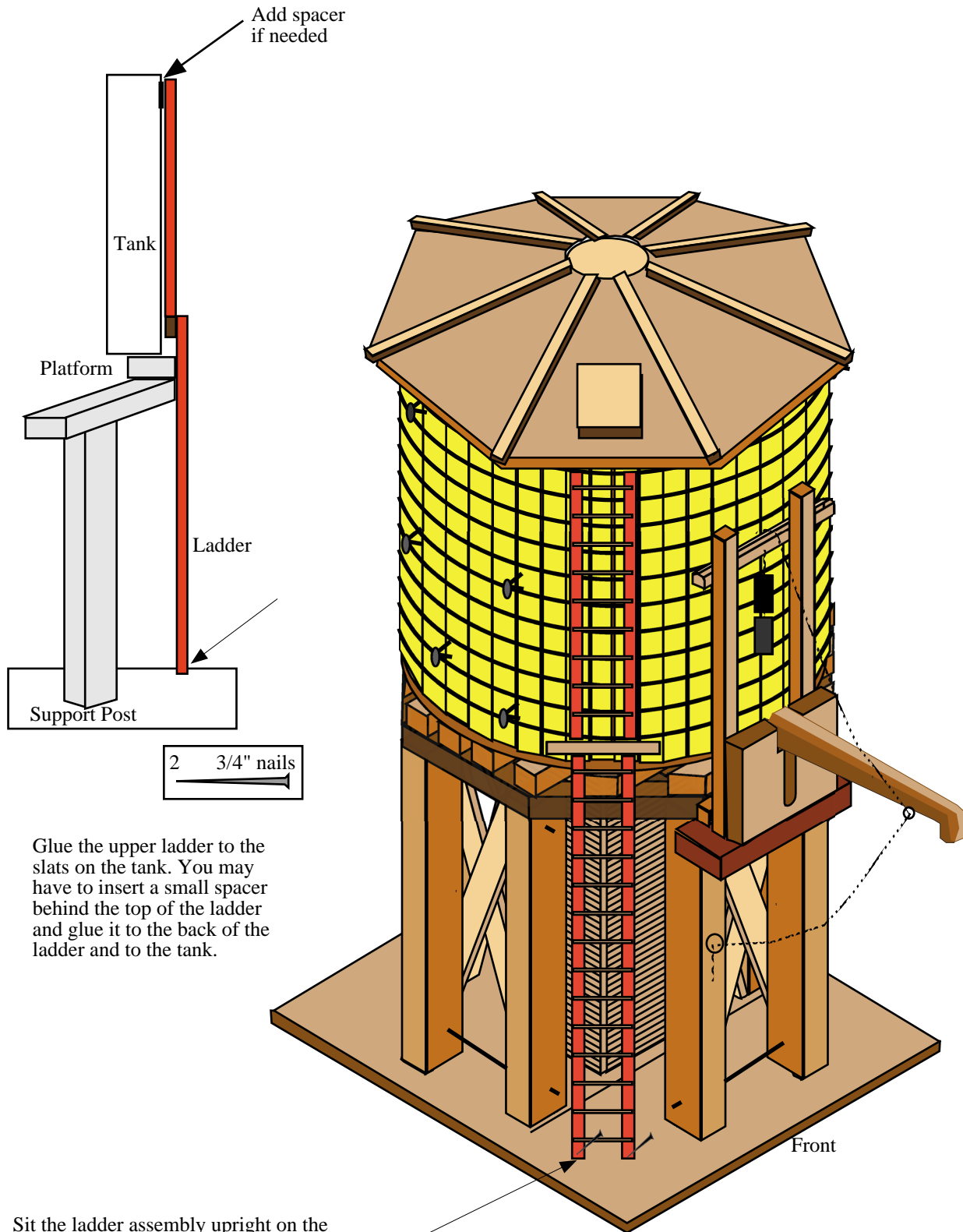

Glue the upper ladder to the slats on the tank. You may have to insert a small spacer behind the top of the ladder and glue it to the back of the ladder and to the tank.

Sit the ladder assembly upright on the base and position it straight against the tank.

Drill a small pilot holes in each of the lower ladder sides. Secure ladder to the base with a small nail and glue on each side.

Add the lid. It will simply fit inside the tank. Position it so that the roof door fits directly over the ladder.