

- Build your houses from 1/4" plywood to your own design
- Decorate with commercial trims or make your own trims
- Add commercial windows and doors on the 1:24 scale or build your own from 1/8" wood. Garden Towns Doors and Windows patterns sold separately.
- Optional: Add lights, using manufacturer's instructions

Scaled and easy to read patterns and instructions for wood houses. Yard and Garden Buildings Compatible with Garden Railroads or a delight for any child's collection

**House Patterns:**  
 Walls, roof, and foundation  
**Accessories Patterns:**  
 Room Addition  
 Porch  
 Chimney  
 Dormer

Overall Dimensions

Basic House Foundation\*: 10" x 15-1/2"  
 Walls: 1 Story - 5-1/2" high with 10" roof peak  
 2 Story - 10" high with 15" roof peak

\*Room addition, porch or chimney will add to foundation



1  
 Basic House  
 (no additions)

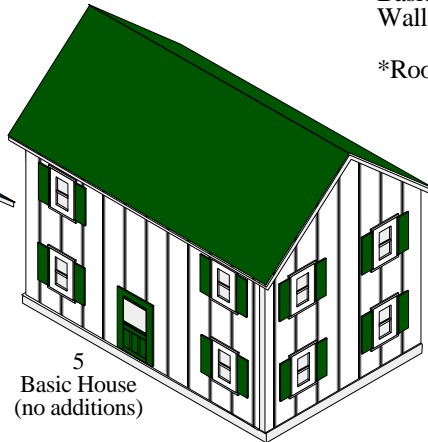

5  
 Basic House  
 (no additions)



6  
 With room addition on side  
 centered porch and centered ground chimney

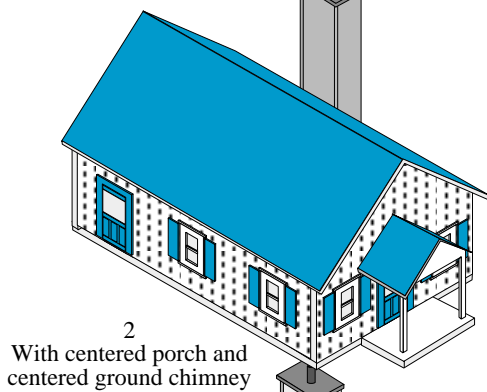

2  
 With centered porch and  
 centered ground chimney

There are nine houses illustrated  
 with specific walls.  
 Walls shown are not inclusive.  
 You can mix and match the wall  
 arrangements to design your  
 own house.

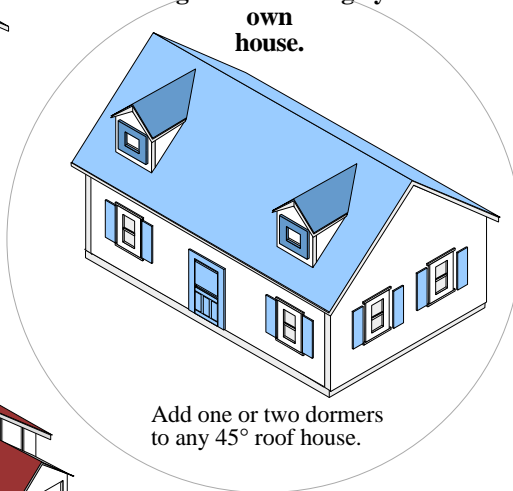

Add one or two dormers  
 to any 45° roof house.

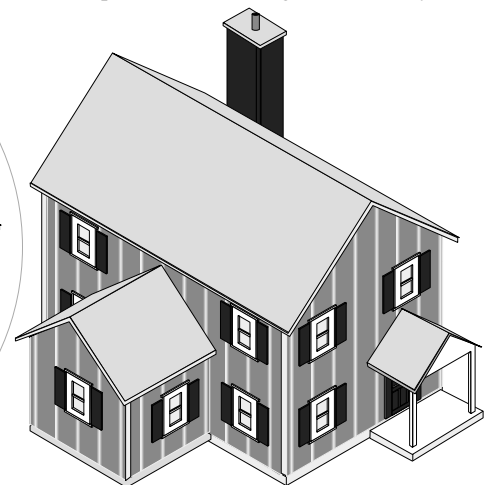

7  
 With room addition on side, porch to  
 side  
 and ground chimney to side

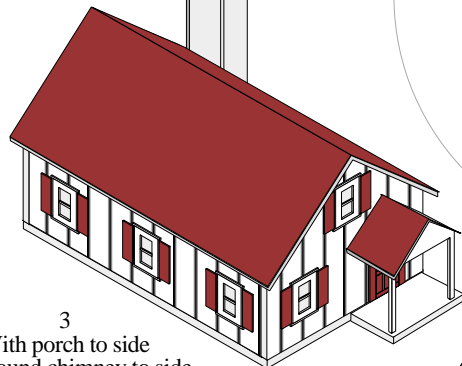

3  
 With porch to side  
 and ground chimney to side

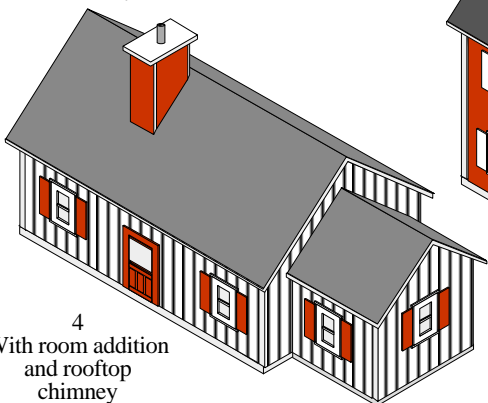

4  
 With room addition  
 and rooftop  
 chimney

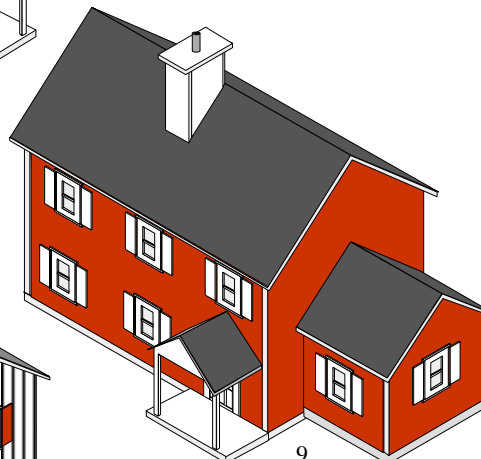

9  
 With room addition on end,  
 rooftop chimney and porch to side

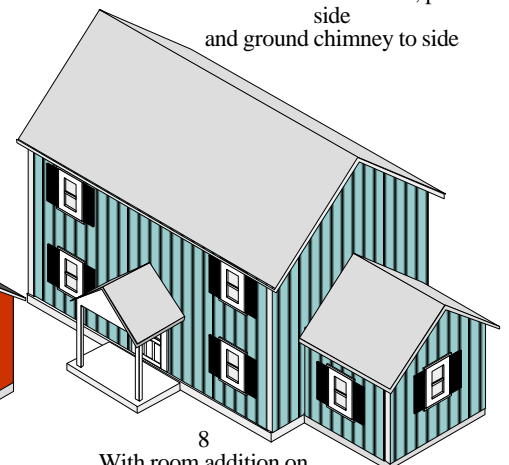

8  
 With room addition on  
 end  
 and centered porch



Thank you for purchasing the Garden Town pattern. As a background, the Garden Town houses and buildings were inspired by the Garden Scale Railroads. We wanted to build small towns as backdrops for the trains. After building several prototypes, we discovered that they are actually fun to make. They don't even have to have a railroad to accompany. Depending on your choices, each of the houses can be different. They can be an addition to your flower garden. Or a backdrop toy for a child. If you are building yours for outside display, do keep in mind the elements. Houses will have to be sealed with polyurethane or varnish to minimize weather damage.

Please take a few minutes and go over the Steps to Building Your House before you begin.

We hope you enjoy your project!

---

Table of Contents

<b>Before You Begin</b>	
<b>Steps to Building Your House</b>	3
<b>Tools and Supplies</b>	
General	4
Door and Window Requirements	5
Working With Small Items	6
Layout - Accessories Only	7
Layout - Houses with Accessories	8
The Frame	9
<b>Hints and Tips</b>	
Two Ways to Assemble Roof	10
Mitering	11
<b>Planning the House</b>	
1 Story Plans to choose from	12
2 Story Plans to choose from	14
<b>Planning the Walls</b>	
Addition walls and 1 Story Side Walls	17
1 Story End Walls	18
2 Story Side Walls	19
2 Story End Walls	21
<b>Accessories - Patterns and Assembly</b>	
Chimney	22
Dormer	26
Porch	28
<b>Patterns</b>	
1 Story House Walls	30
2 Story House Walls	31
Roofs for 1 or 2 Story	32
Room Addition - all 45° Roof Houses	33
Foundations	34
<b>Assembly</b>	
Walls	37
Building	39

Planning the House - 1 or 2 Story Plans to choose from - Decide which house you will build. If you use one of the houses we have illustrated, we have indicated which floor plan patterns and wall fitments to use.

Planning the Walls section is to be used as a guide for placement of doors, windows, chimney and room addition.

**Accessories:**

A Room Addition or Porch will fit on the End Wall of a 1 or 2 Story House. They will fit on 2 Story Side Walls only. (The roof line is too low on a one story house).

Roof Chimney will fit on any house. Don't place the chimney directly over a door or window. Towards the peak of the roof is the desired area.

Ground Chimney can be used on 1 story or 2 story house.

The 2 story chimney is taller. Dimensions are given for the patterns. Be sure and use the appropriate roof half which has the chimney cut-out. Use Floor Plan 2 or Floor Plan 4 which has a chimney base.

Dormer can be used on any of the roofs.

Doors and Windows

Opening Type Doors - If you use commercially purchased doors, you will have to cut into the house frame. Our illustrations show how to make the opening. The size of the opening will depend upon the doors and windows you purchase and the instructions which come with them.

Non-Opening Doors-Such as Kiva Design Garden Town Doors and Windows, which you build yourself, you can build a simple "box frame" for the house. The window openings will be above the frame and the 1/8" thick doors will fit into the 1/4" walls.

Keep in mind:

A house should have a minimum of 2 exits (doors). Door and window openings will need to be at least 1" from the sides and 1" from the top of the wall so they don't interfere with the building frame behind the walls.

**Before You Begin**

**Tools and Supplies -**

"Layout"

Record how much 1/4" Plywood you will need to build the house you want.

"Door and Window Requirements"

Record how many you will need. Decide if you want to purchase or build. Record supplies you will need.

"Frame"

Record how many feet of 1" Furring Strip you will need.

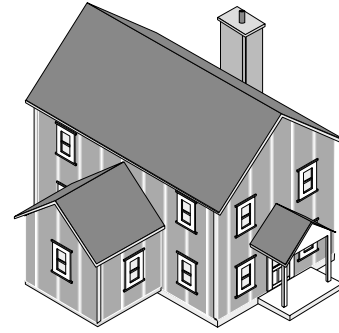

Optional - Items to consider from the hobby store:

Lights - Add Lights according to manufacturers instructions. We suggest that you use screws instead of nails when attaching the roof to allow future access to the wiring and bulb.

You can buy scaled wood shingles for your roof as well as assorted other detailed items. You can make your own signs with help from a stencil or the stick-on letters and numbers available.

**Ready to Build**

Determine which patterns you will need:

- 1- Foundation
- 2- Side Walls
- 2- End Walls
- 2 - Roof Halves
- Accessories, as desired

- Cut out all wood, according to Pattern dimensions.
- Mitre the pieces, as indicated on the patterns (see **Before You Begin - Hints and Tips - "Mitering"**).
- Cut Furring Strips for frame (see **Before You Begin - Frame**).
- Measure and cut out door and window openings from the walls, as needed (see Assembly - Walls).
- Sand off any rough edges.
- Optional: Paint or stain the walls. Dings can be touched up later. You may prefer to do this step after assembly is completed.
- Assemble the Accessories, as per individual instructions.

- Assemble the building (see Assembly - Building).

If you are placing your house outside, be sure to protect it with a good seal of polyurethane or varnish.

Window and Door Placement

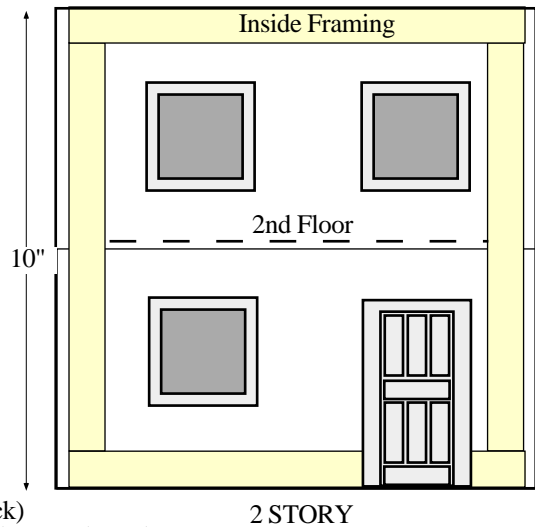
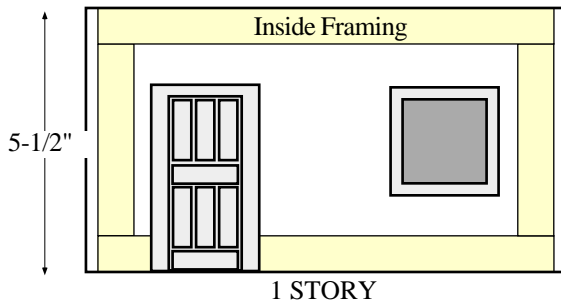

- Buildings and porches are constructed from 1/4" thick plywood
- Framing for the walls is made from 1" Furring strips (nominally 3/4" thick)
- Garden Town Doors and Windows are made from 1/8" thick Balsa wood or Hardwood and plastic glazing for the window panes
- Windows and doors have to be at least 1" from sides and top (to clear inside building frame)
- Doors are placed at floorline
- Floorline on 2nd floor will be 5-1/8" from bottom of wall
- Windows are placed with tops level with doors (some exceptions)

For a few hints to experiment with on the wall finishes, see "Simulated Patterns" in our free **Food for Thought** brochure.

**Tools Needed for Building**

- Saw (for cutting small wood pieces, a jig saw or coping saw)
- Hammer or Stapler or Air Gun
- Drill (optional for pilot holes)
- Clamps
- T-Square
- Level
- Ruler and Pencil (We prefer see-thru rulers with grids for the small pieces)

**Plus If you are making Doors & Windows from Balsa wood**

- X-ACTO knife and metal ruler for guide
- Optional:**
- Ruler - the plastic see-thru kind with 1/8" grid is a plus
- Balsa stripper - This little gizmo is used for making various widths of uniform strips from balsa wood. You can set it to cut small widths, (1/8", 1/4", 1/2" etc.)It saves a lot of time if you prefer to cut your own strips.
- Of course you can buy the strips "ready made" at a higher price.
- Clamps (small) - The X-ACTO clamps for small pieces are very handy.

**Supplies Needed - General**

- 5/8" Staples or Brads
- 1" #6 Wood Screws, flat head
- Small 3/8" - 1/2" wood screws flat head
- 2" Finishing Nails
- Wood Glue
- Paint or Stain - We suggest the water based Acrylic Paints found in a multitude of colors in arts and crafts stores.
- Sealer - Water Base Varnish found with the acrylic paints or a sealer such as polyurethane.
- Optional: Caulking for sealing porches, roofs, etc.

Guide for 1" x 1" x 8' Furring Strips		
1	8'	96"
2	16'	192"
3	24'	288"
4	32'	384"
5	40'	480"

<b>Specific Building Supplies Large 45° Houses</b>		For Details See Page
<b>1/4" Plywood</b>		
1 Story	48" x 42"	8
2 Story	48" x 47"	8
(No. of Sheets)	(1) 4' x 4'	any house
<b>1" x 1" Furring Strips (nominally 3/4" x 3/4")</b>		
1 Story	152"	9
2 Story	184"	
<b>Purchased Doors &amp; Windows or 1/8" Balsa or Hardwood (4" x 36" Boards)</b>		5
Doors & Windows		
1 Story	2	
2 Story	3	
<b>Clear Plastic Glazing for Windows</b>		5
8" x 10" Sheet	1	
Optional Small Parts Frame - Page 6		
1/4" Plywood - 12-3/4" x 12-3/4"		
1" x 1" Furring Strips - Add 52"		

**Doors and Windows**

Option: You can purchase ready-made doors and windows which actually open. For example, Grandt Line carries a well made and ready to paint plastic selection for Scale 1:24.

or

you can make your own (Garden Towns Doors and Windows Patterns by Kiva Design) These doors and windows are also 1/24 scale, but are a little larger overall for ease in building. They are non-opening (no hinges).

The following are samples represented for the scaled dimensions.

Buildings are illustrated with the Kiva Design Samples. Neither of the samples are inclusive all all doors and windows available.

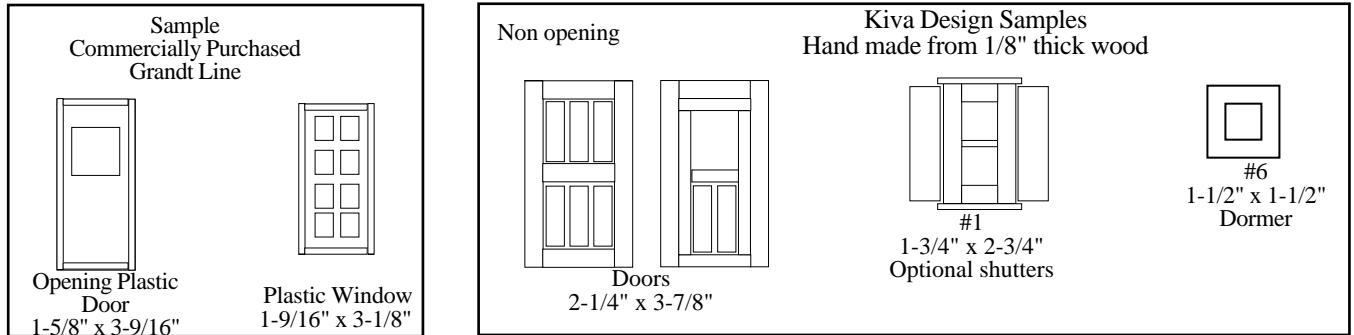

•Purchased Doors and Windows as required

OR

•1/8" Balsa wood or Hardwood for Doors and Windows:  
 4" x 36"

(common size at hobby shops)

House	Doors	Kiva Design # 1 Windows	1/8" thick Balsa Wood or Hardwood Number of 4" x 36" boards needed for houses shown*
1 1 Story	2	10	2
2 "	2	9	2
3 "	2	9	2
4 "	2	8	2
5 2 Story	2	17	3
6 "	2	16	3
7 "	2	15	3
8 "	2	14	3
9 "	2	15	3

Use your choice of Garden Towns doors

\*Doors and windows shown for the building can be made from the number of boards indicated. However, "we" personally always buy one extra board in the unlikely event that we'll need it to redo our "errors". Left-overs are saved for the next project.

•Clear Plastic for Windows  
 8" x 10" Sheet  
 (from hobby shop framing area)

**Assembly Frame for Small Items**

**Patterns**

Cut from plywood -1/4" thick or any scrap

Cut from 1 x 1 Framing (nominally 3/4" x 3/4")

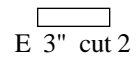
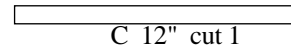
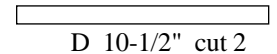
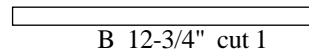
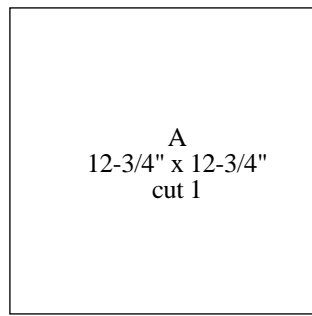

**Assembly**

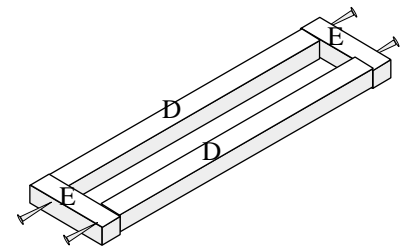
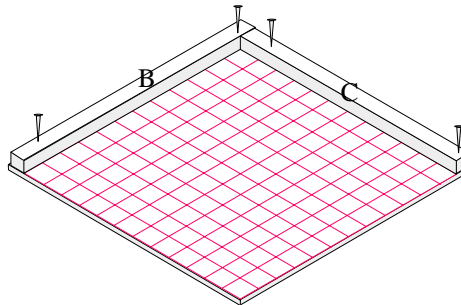
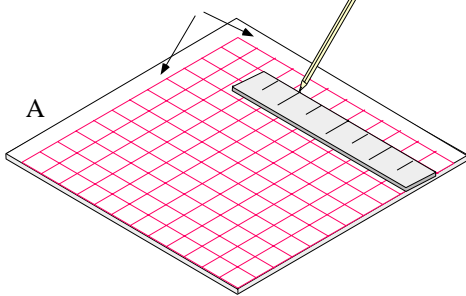

1. Using pencil or pen and ruler, draw lines 3/4" inside of 2 adjacent sides of the base. The frame will be placed in this area. From those 2 lines, draw lines at 1" intervals, forming a 1" grid.

2. Nail and glue frame parts B and C in place, as shown, maintaining a square corner.

3. Using glue and nails, assemble the frame "push bar", as shown. Again, make sure that the corners are square.

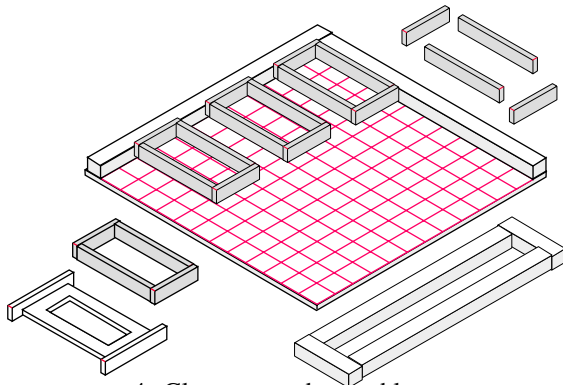

4. Glue parts and assemble inside the frame. The grid will help you keep the pieces straight. You can assemble several "like" pieces at one time.

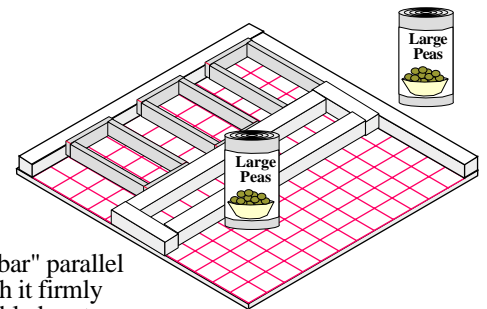

5. Keep the "push bar" parallel to side C and push it firmly against the assembled parts. Use anything with weight to hold the push bar in place until parts are dry. Canned goods you didn't want for dinner work well.

**Trimming 1/8" Balsa wood or hardwood**

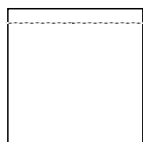

1. Using ruler and pencil make a line 1/8" from the inside edge to be mitered

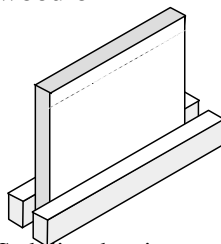

2 Stabilize the piece to be mitered with a clamp or other means

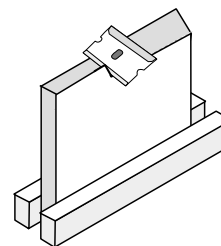

3. With blade, carefully trim from the top outside to the marked line. Alternately, the piece can planed or sanded.

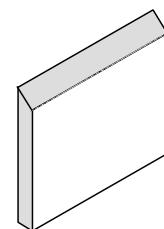

Trimmed on the inside

**Accessories Only**  
**1/4" Plywood**

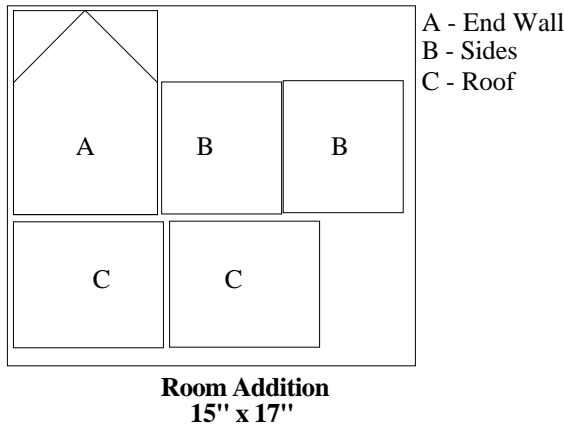
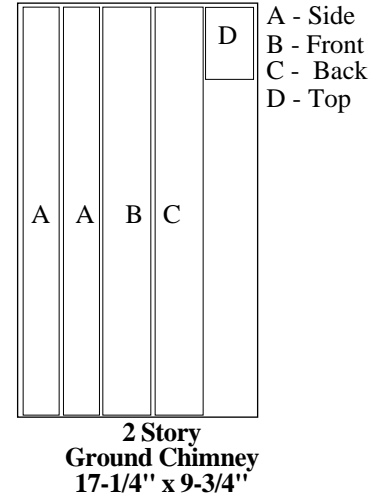
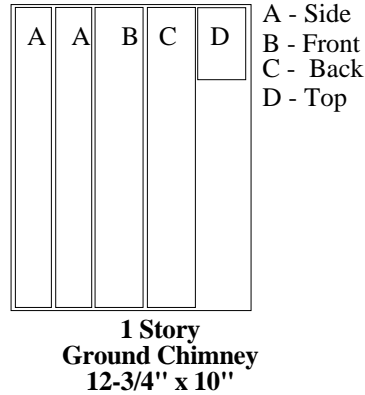
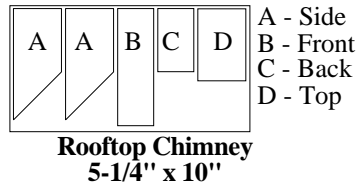
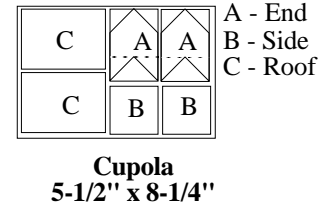
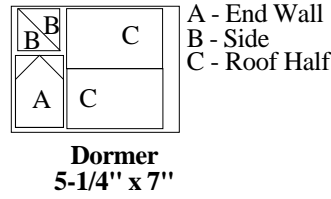
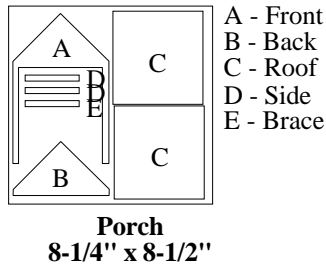

Note for House Layouts on following page:  
 The space allowed for foundation and additions  
 represents the Basic Foundation and room for  
 Addition placements, according to the floor plans  
 provided.

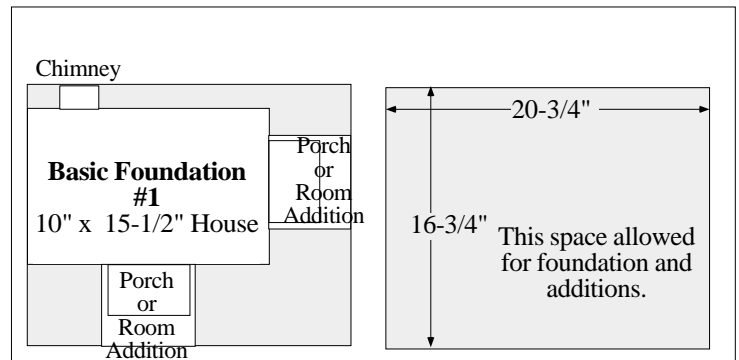



**1 Story  
 Cut from  
 1/4"  
 Plywood**

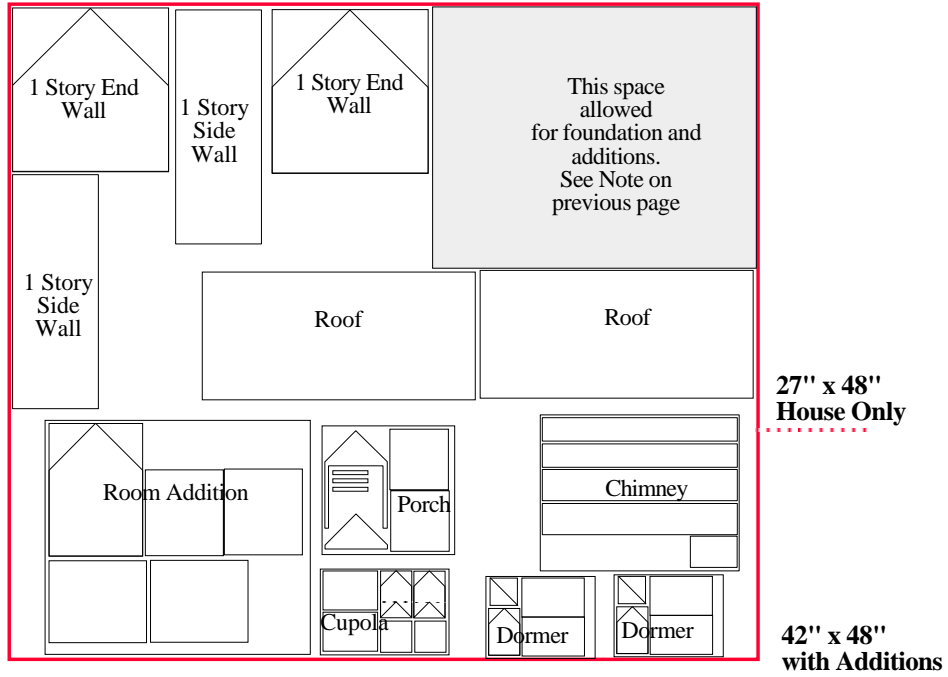

**2 Story  
 Cut from  
 1/4" Plywood**

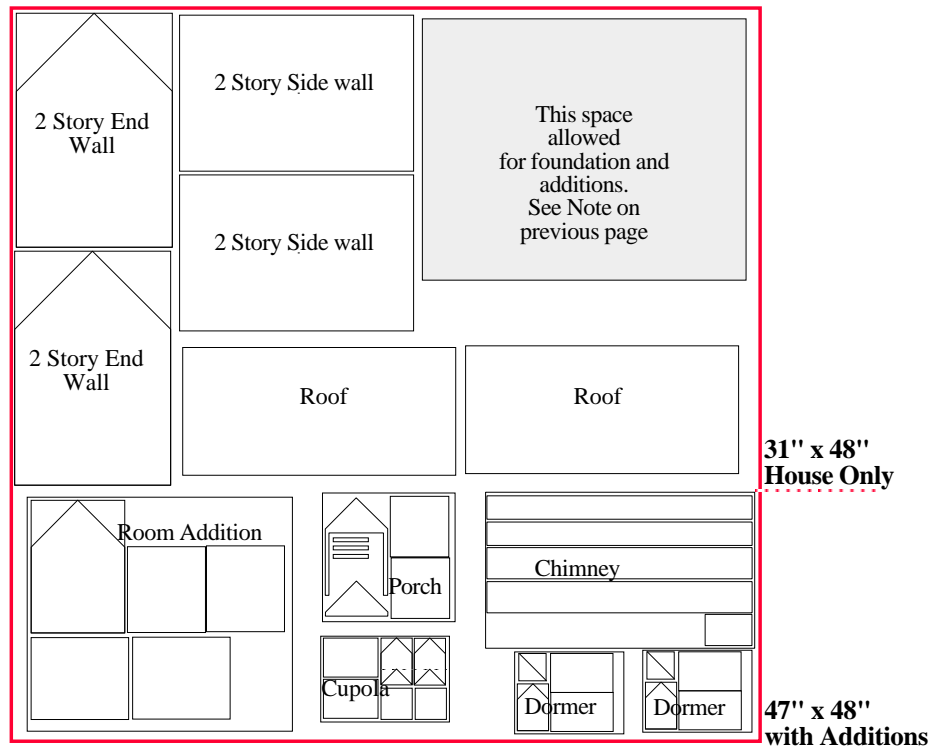

**The Frame**  
 You will need to build a frame for which to attach the walls.

If your building will have doors which do not physically open, you can build a simple box for your wall braces. The windows and doors will fit into the walls.

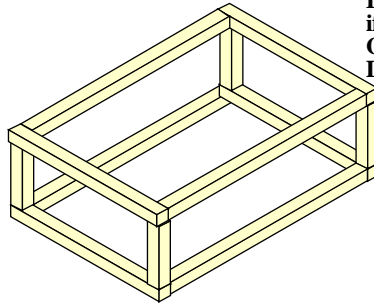

**Build this frame if you are using Garden Town Doors and Windows**

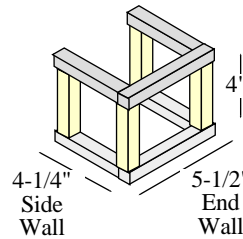
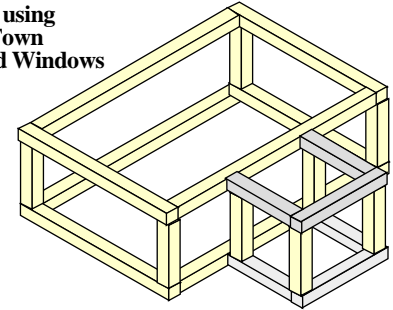

Room Addition	
4 @ 4-1/4"	17"
2 @ 5-1/2"	11"
4 @ 4"	16"
<b>Total</b>	<b>44"</b>

If your house will have doors which do physically open, you will be cutting openings in the bottom frame.

**Vertical Braces for:**  
 1 Story Houses and all Room Additions are 4" high.  
 2 Story Houses are 8-1/2" high.

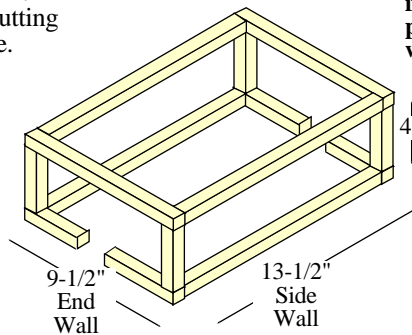

**Build this frame if you are using purchased doors which open**

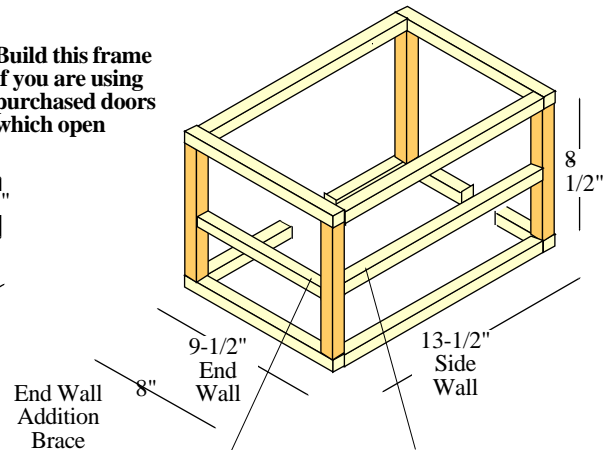

Two story houses with a room addition will need 1 extra horizontal brace.  
 •Side wall brace will be the same length as the side wall frame.  
 •End wall brace 1-1/2" shorter to fit inside the vertical frames.

**Frame Assembly is shown on page 40.**

1" Furring Strips for Framing 1 Story	
4 @ 9-1/2"	38"
4 @ 13-1/2"	54"
4 @ 4"	16"
<b>Total for Basic House</b>	<b>108"</b>
<b>Addition Total</b>	<b>44"</b>
	<b>152"</b>

1" Furring Strips for Framing 2 Story	
4 @ 9-1/2"	38"
4 @ 13-1/2"	54"
4 @ 8-1/2"	34"
<b>Total for Basic House</b>	<b>126"</b>
<b>Addition Total</b>	<b>44"</b>
1 @ 8" or	
1 @ 13-1/2"	13-1/2"
	<b>183-1/2"</b>

Conversion Inches = Feet	
12"	1'
24"	2'
36"	3'
48"	4'
60"	5'
72"	6'
84"	7'
96"	8'
108"	9'
120"	10'
132"	11'
144"	12'
156"	13'
168"	14'
180"	15'
192"	16'
204"	17'
216"	18'
228"	19'
240"	20'

**Note: 1" Furring strips are nominally 3/4" square. If yours are different, make adjustments so that they fit in the same area as the assembly diagram indicates on page 40.**

**Roofs made from 1/4" plywood**

There are two ways to assemble your 45° roof. Either way will allow the two halves to meet at the top smoothly.



Areas that need to be mitered in order to fit will be designated with this icon on the pattern. The specific mitering angle is noted on the pattern page.

**Method 1 - Miter the Tops**

The first and more professional procedure is to miter the top edges of the roof halves on the inside. One way you can do this is to cut out the roof with a jigsaw which has an adjusting base plate. Example:

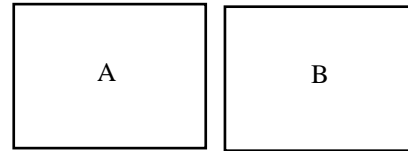

Both roof halves are each 3" high x 4" long

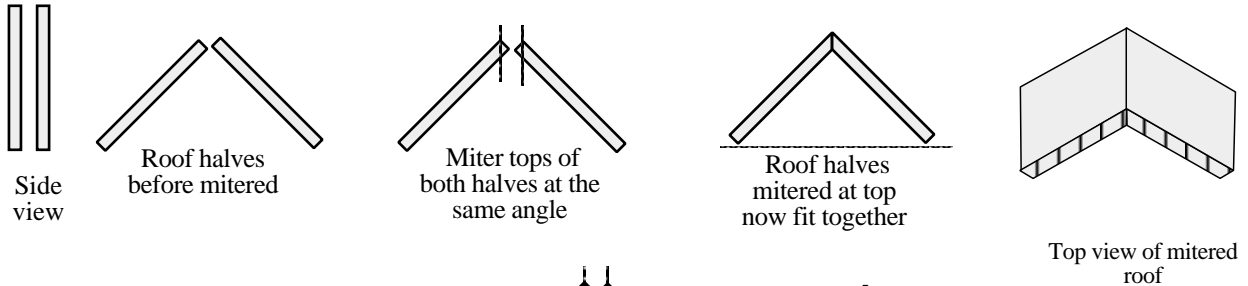

Optional:

As a matter of taste, you may also choose to miter the inside bottom edge of the roof. If you miter the bottom of the house roof, you should also miter all addition roofs you will use with the house.

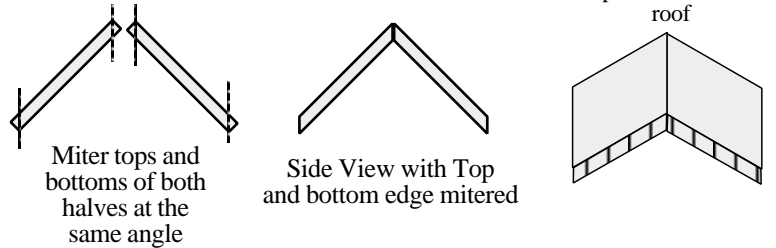

**Side wall Option**

Mitering the side wall will allow the roof to fit better.

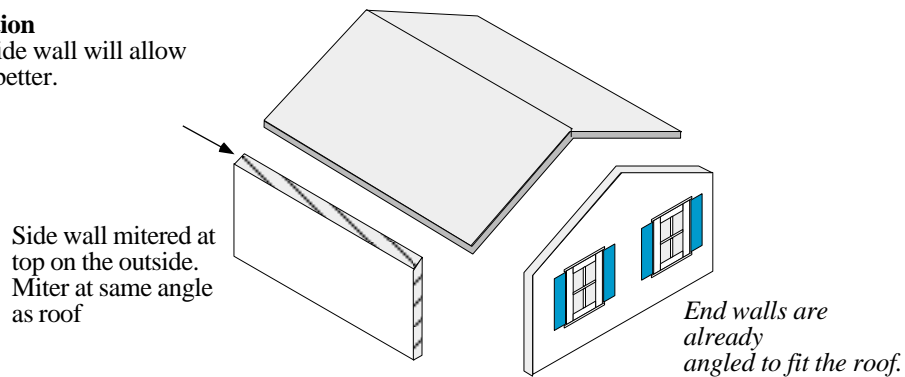

**Method 2 - No Mitering**

Add 1/4" to the height of one roof half only  
 Example

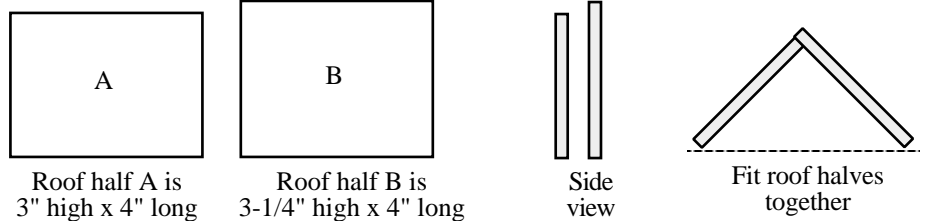

**Roofs made from 1/2" plywood**  
Add 1/2" to the height of one roof half only

No matter what depth of wood you use,  
Always add the depth of the wood to one half only

**Chimneys - Rooftop Type**

The Back is always towards the peak of the roof and is shorter than the Front to accommodate the slope of the roof.

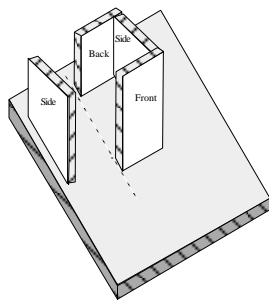
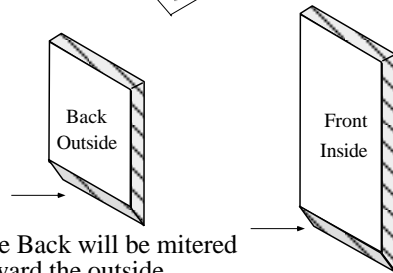
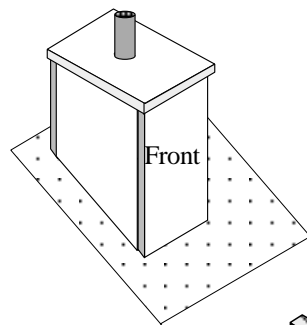
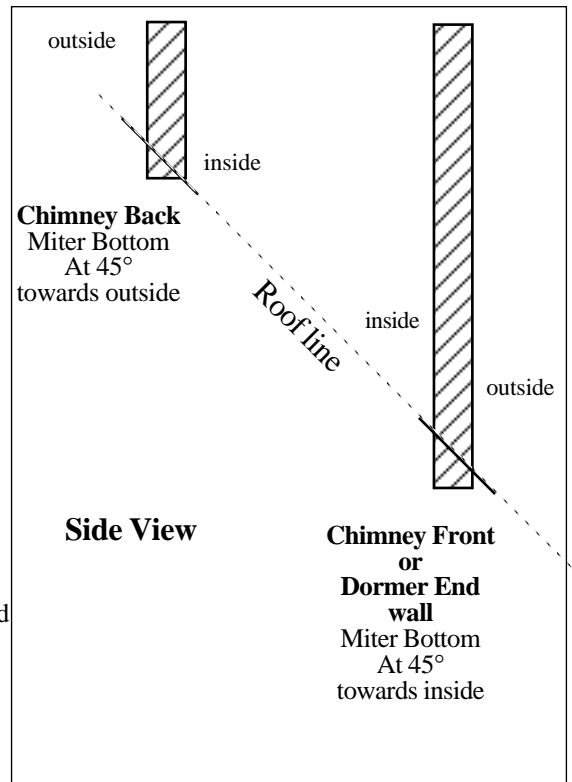

Illustration to show placement only. Chimney to be completed before attaching to roof.



The Back will be mitered toward the outside

The Front will be mitered toward the inside.  
 Same as for Dormer End Wall



**Dormers**

**Dormer Roofs**

Miter in same manner as the main roof so that the tops will fit together smoothly.

If you have also mitered the bottom sides of the main roof, you'll want to miter the bottoms of the addition roof to correspond.

**There is one additional step for Dormer Roofs.**

In order for the angled edge to fit onto the main roof, miter the inside of the angled edge. Miter all three sides at the same angle.

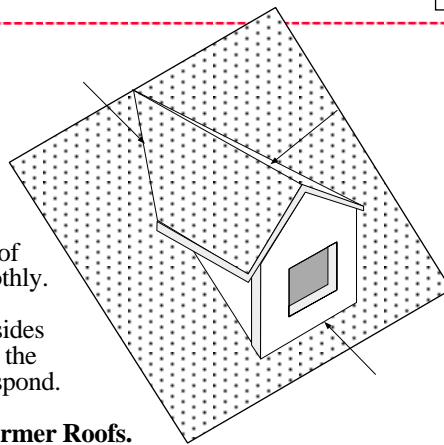

End wall is handled like chimney front.

Inside view  
 Dormer roof half

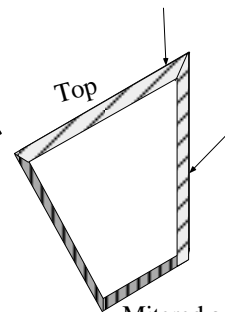

Mitered on top and angled side only

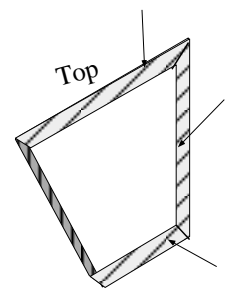

Mitered on top, angled side and bottom.

**Porches**

Any porch with an angled roof will need to be mitered in the same manner as Main roofs

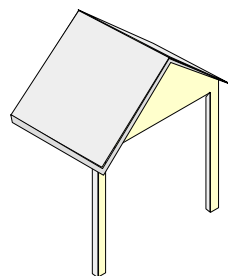

Roof halves will be mitered to fit each other at top

1

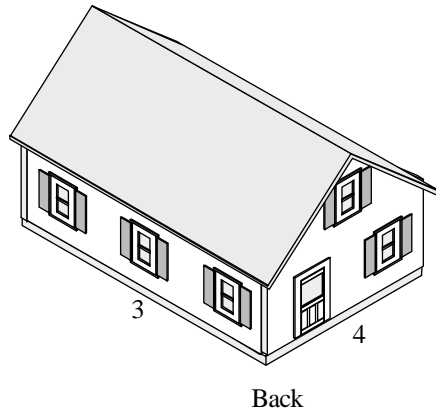
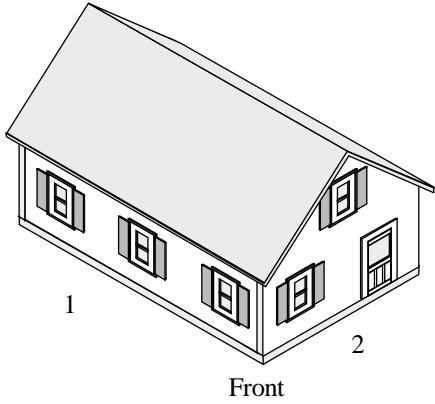

Use Foundation # 1  
 See Planning the Walls  
 for placement details

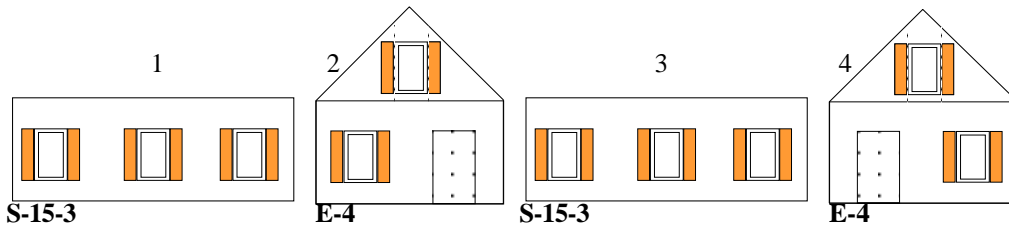
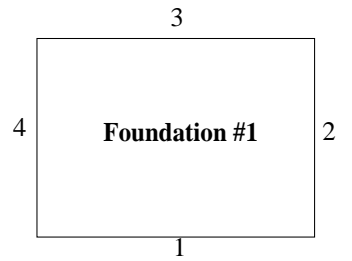

2

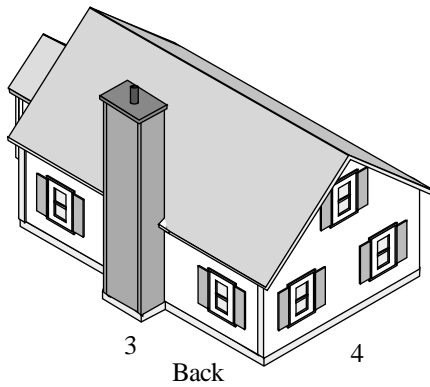
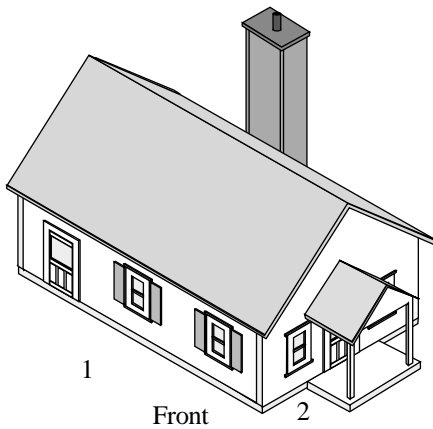

Use Foundation # 2  
 See Planning the Walls  
 for placement details

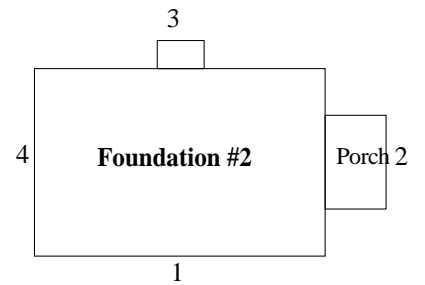

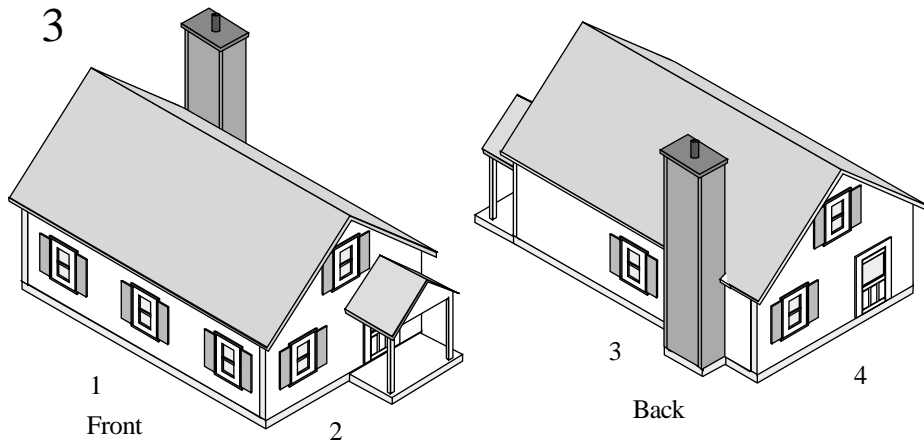

Use Foundation # 3  
 See Planning the Walls  
 for placement details

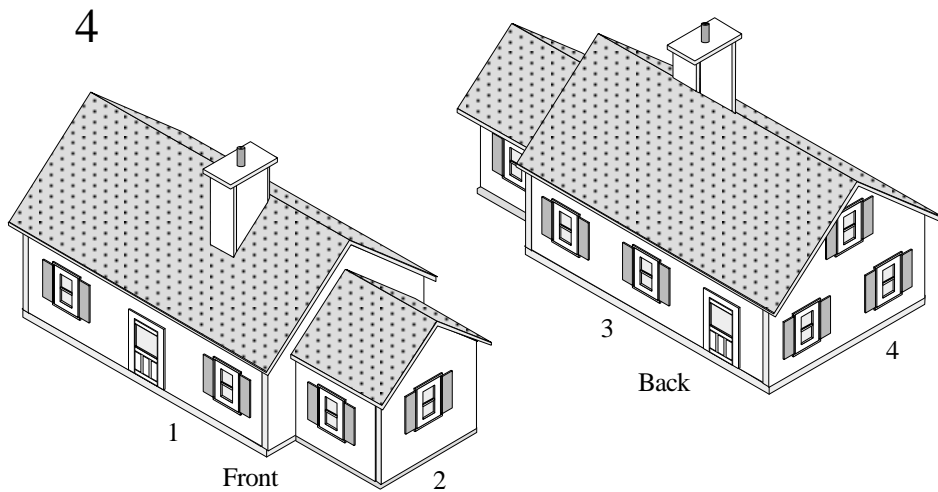
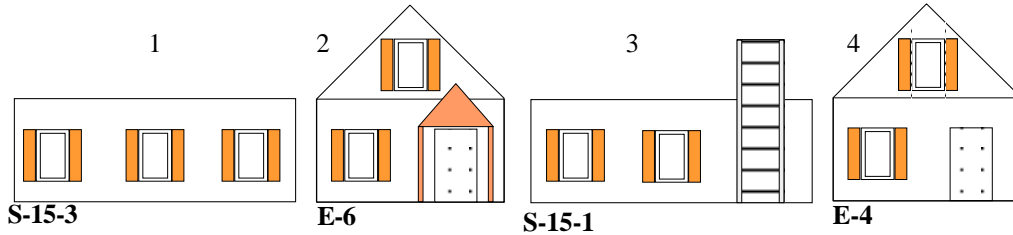
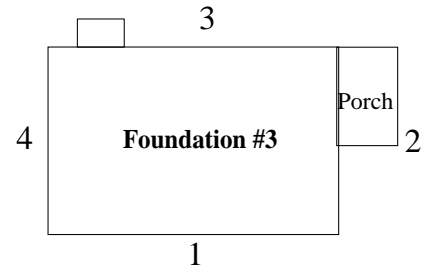

Use Foundation # 4  
 See Planning the Walls  
 for placement details

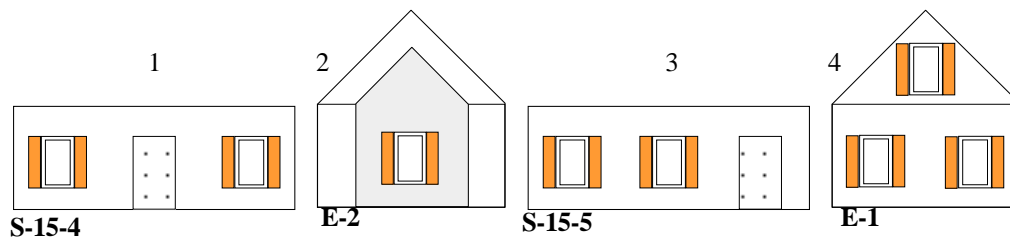
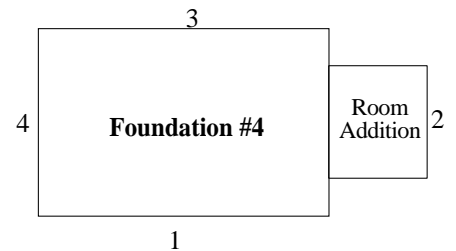

5

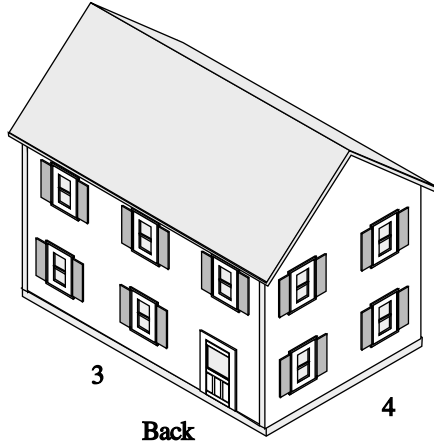
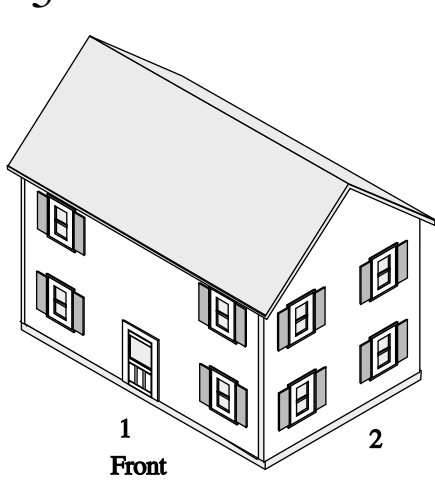

Use Foundation # 1  
 See Planning the Walls  
 for placement details

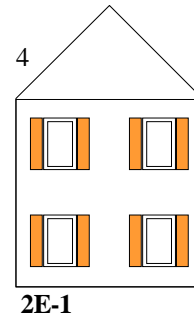
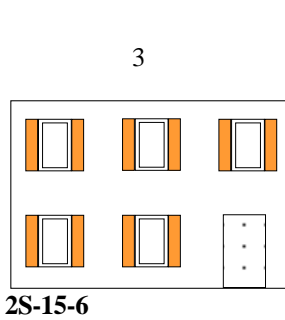
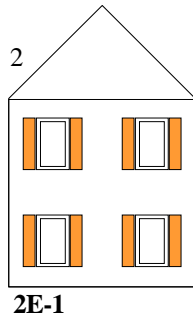
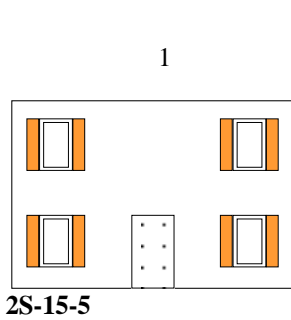
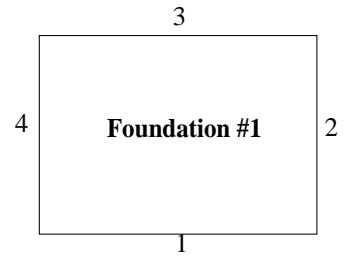

6

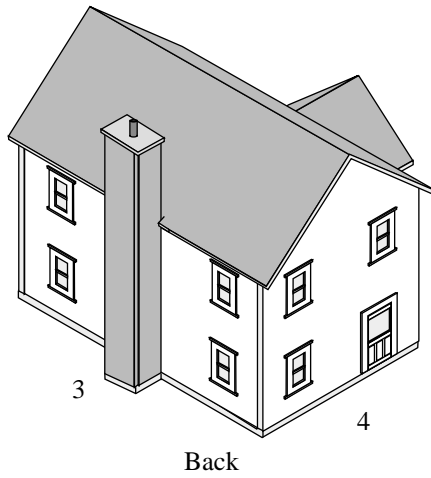
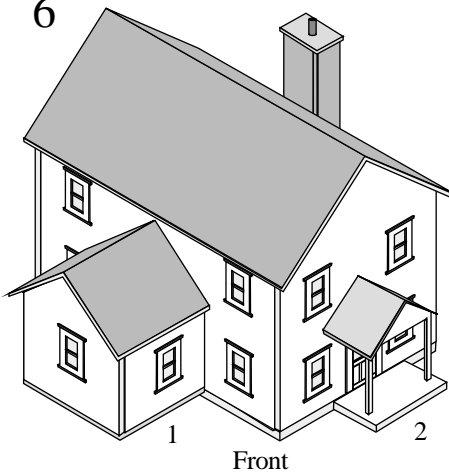

Use Foundation # 2  
 See Planning the Walls  
 for placement details

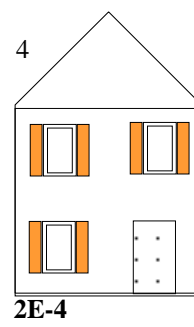
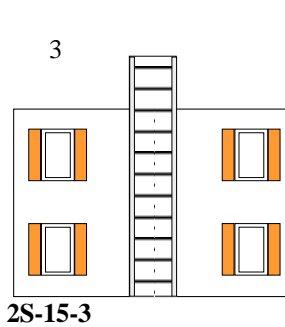
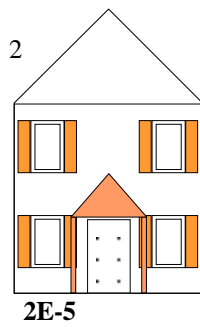
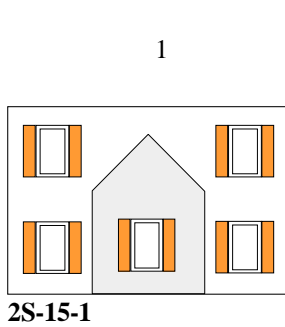
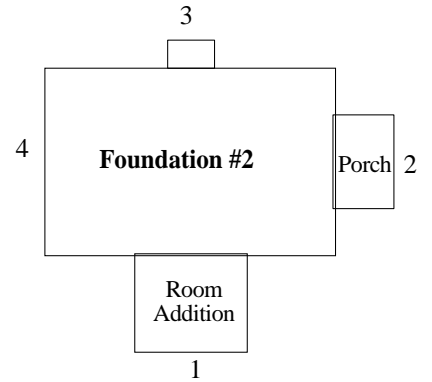

7

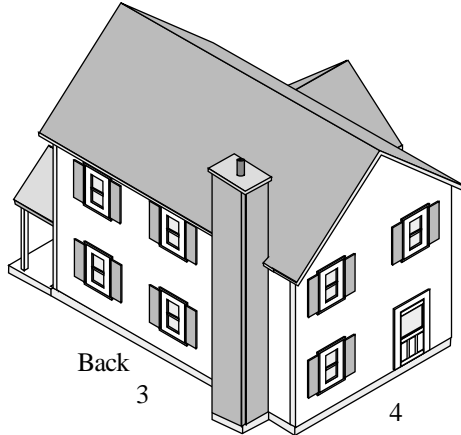
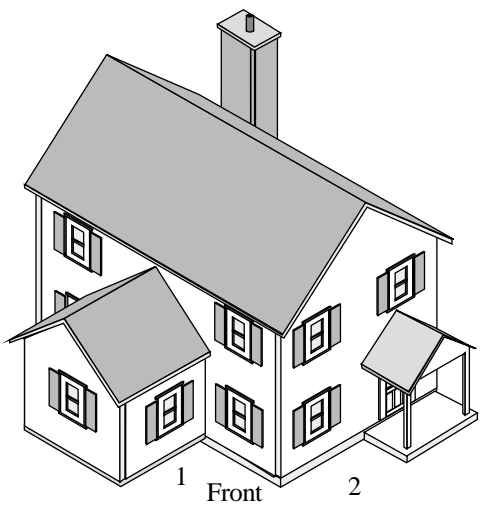

Use Foundation # 3  
 See Planning the Walls  
 for placement details

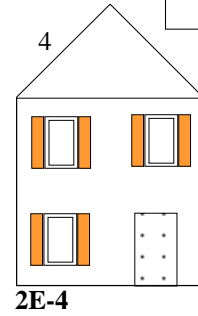
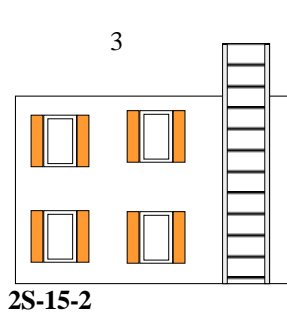
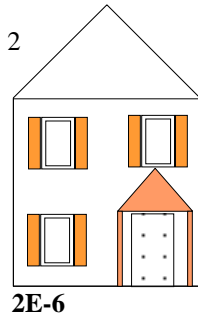
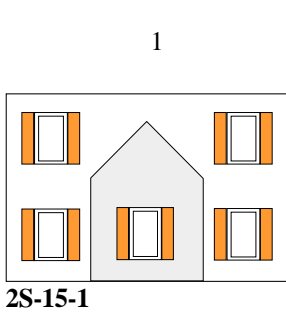
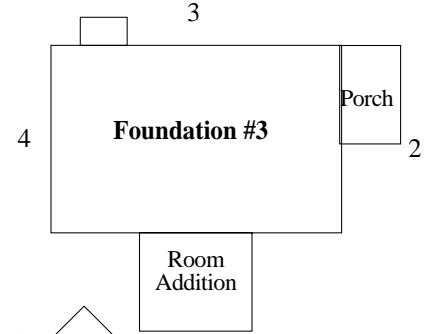

8

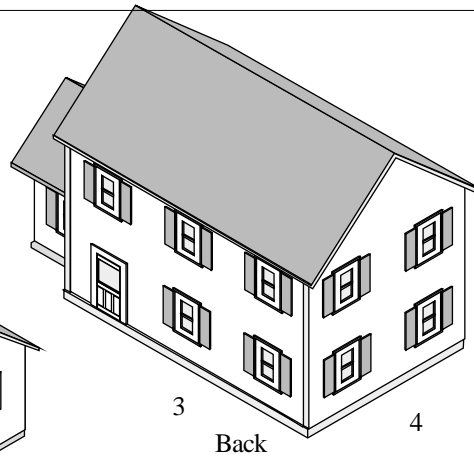
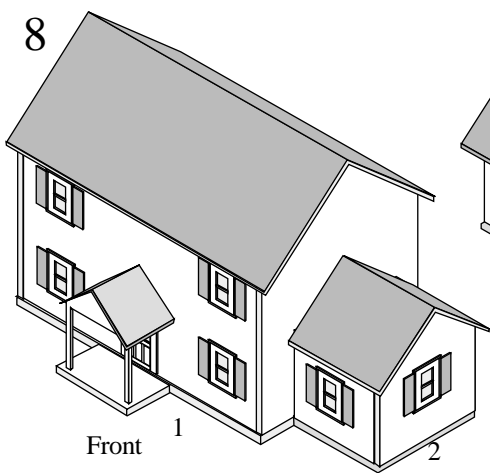

Use Foundation # 4  
 See Planning the Walls  
 for placement details

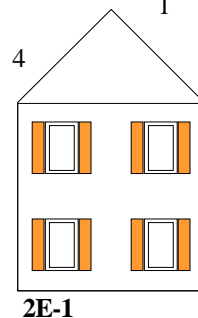
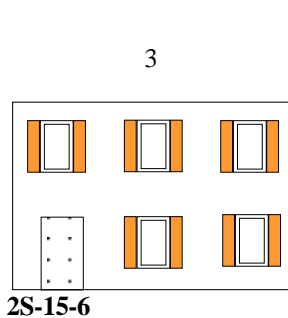
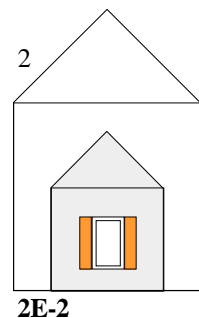
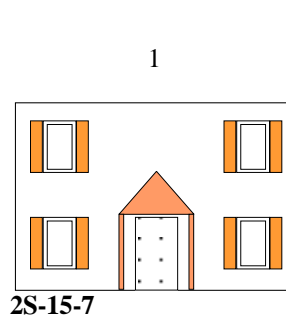
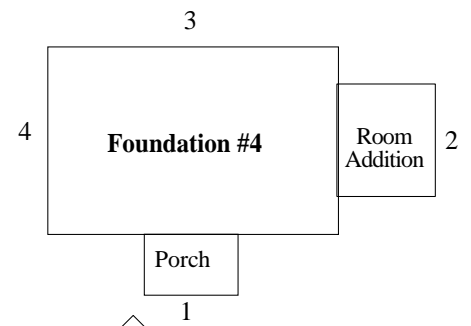



9

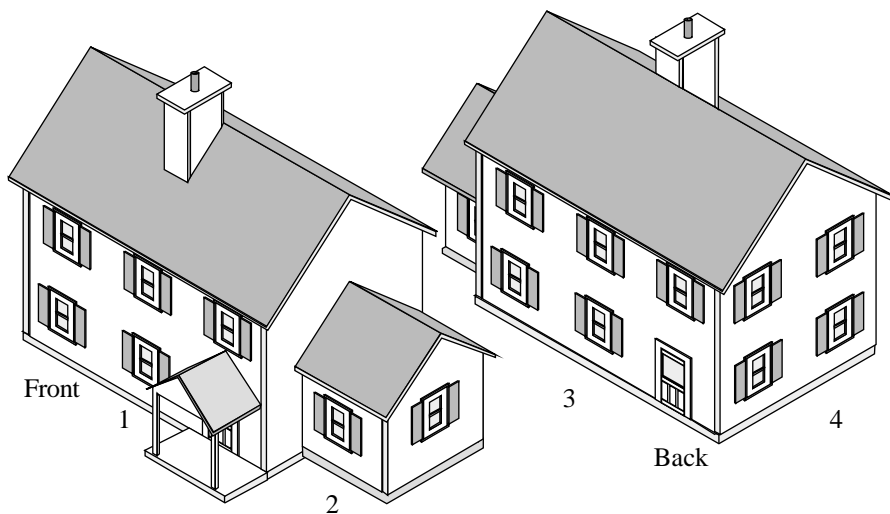

Use Foundation # 1  
 See Planning the Walls  
 for placement details

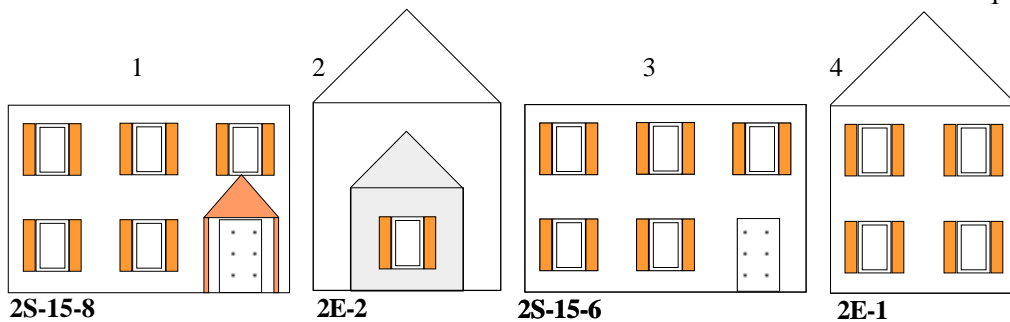
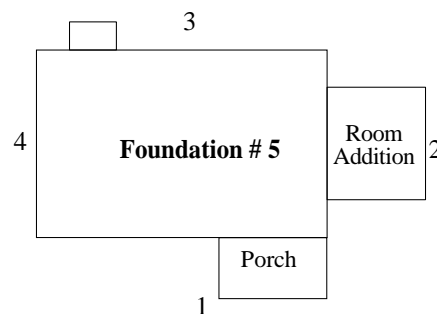

Doors and windows represented on the walls are from Kiva Design Garden Town Doors and Windows. Illustrations are to be used as a guide. If you use different size windows and doors, adjust your placements accordingly. Openings have to be at least 1" from the sides and 1" from the tops of the walls. (See Hints and Tips - Construction Scale Information)

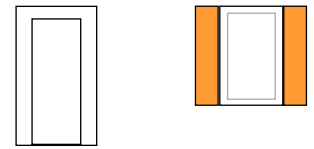

Door 2-1/4" x 3-7/8" Window # 1 1-3/4" x 2-3/4"

1-1/2"

**Important Note:** Spacer measurements shown in the wall illustrations are from a point to window or door frame. They are not the cutting lines for window or door openings. Mark the measurements on your walls. Then use the corresponding window or door templates which will show where to cut the opening. See page 37 for details.

**Room Addition Walls Window and Door Options**

One end of the side wall will be attached to the house wall. The other end will be assembled inside the end wall.

AE-1 AS-1

**1 Story 15" Side Walls**

**Door, Window, Room Addition and Chimney Placements**

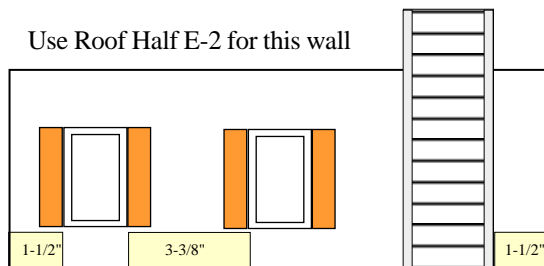

**S-15-1**

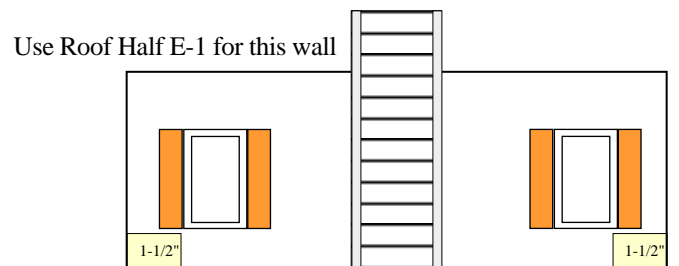

**S-15-2**

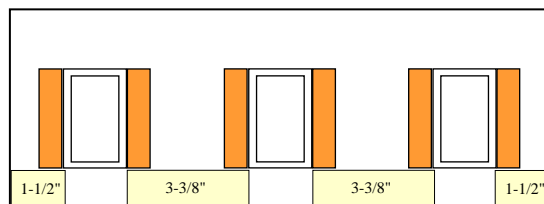

**S-15-3**

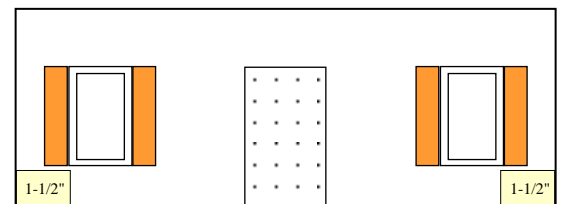

**S-15-4**

Door Centered - Porch will not fit on 1 story side wall

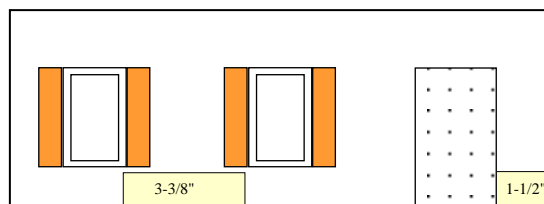

**S-15-5 RH Door**

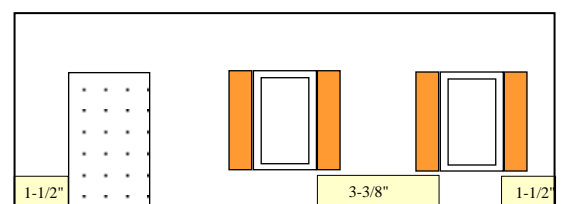

**S-15-5 LH Door**

Door to Side - Porch will not fit on 1 story side wall

**1 Story End Walls**

Door, Window, Room Addition and Chimney Placements

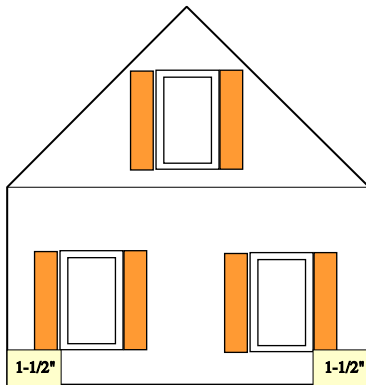

**E-1**

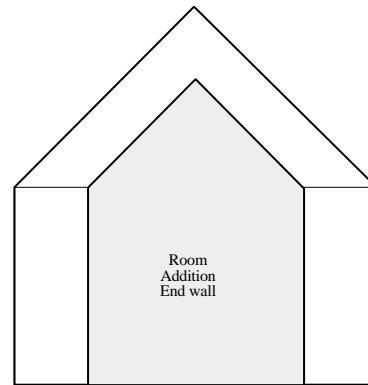

**E-2**

Room Addition  
 Windows can not be effectively used  
 on the house walls.  
 See Room Addition walls for  
 options.

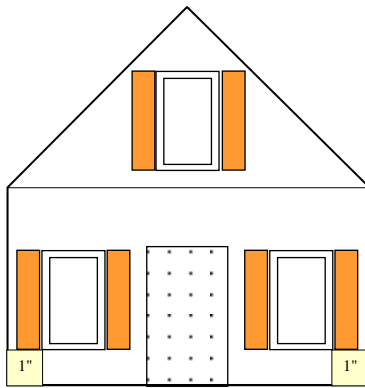

**E-3**

Door centered  
 without Porch can have top window

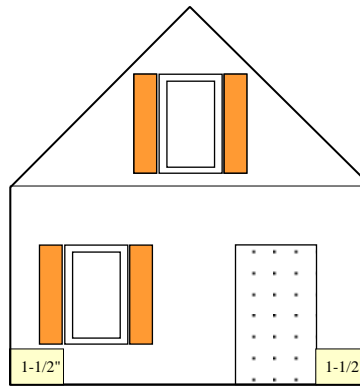

**E-4**

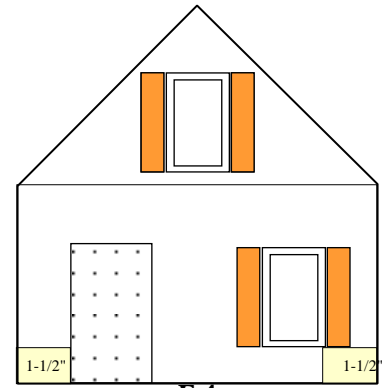

**E-4**

Door to side  
 without Porch

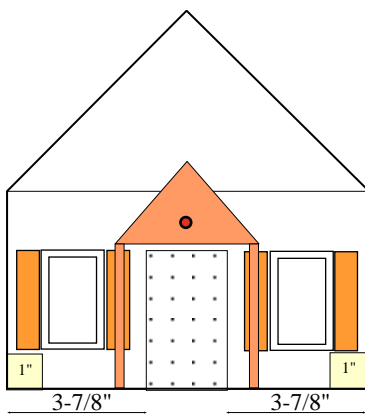

**E-5**

Door Centered  
 with optional Porch  
 Top window will not fit

Wall E-5  
 Drill a very small pilot hole through the  
 wall to attach the porch back. Hole will be  
 centered at  
 5" from each side and  
 4-3/4" above floorline

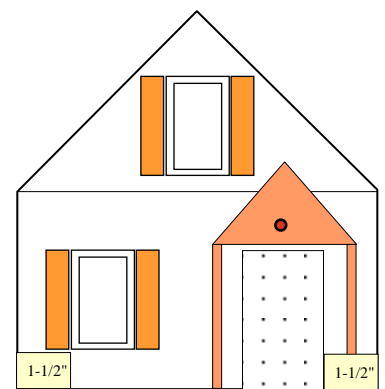

**E-6**

Door to Side  
 with optional Porch  
 and top window

Wall E-6  
 Drill a very small pilot hole through the  
 wall to attach the porch back. Hole will be  
 placed at  
 2-5/8" from the side and  
 4-3/4" above floorline

**2 Story  
 15" Side Walls**

Door, Window, Room Addition and Chimney Placements

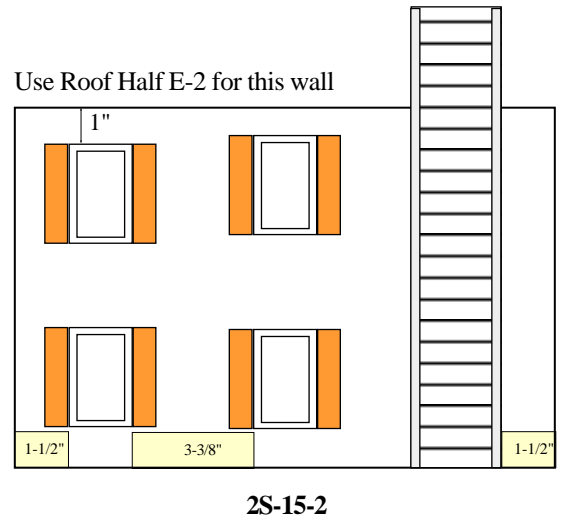
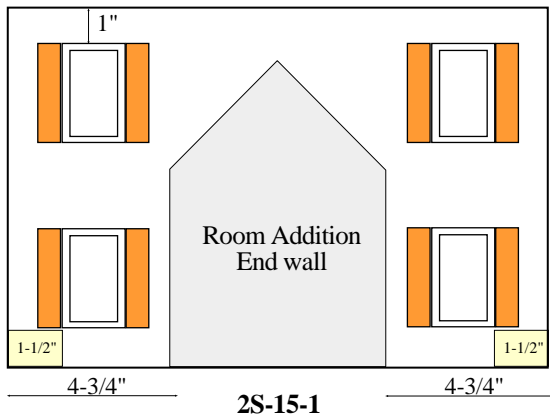

Use Roof Half E-3 for this wall

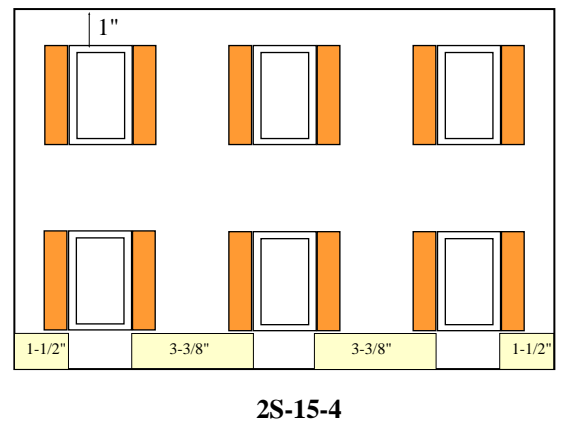
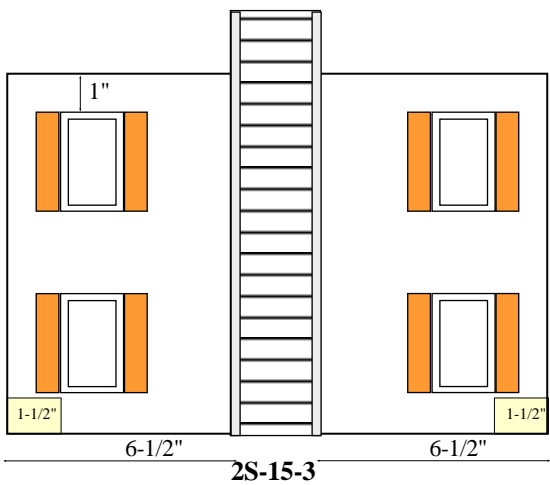

**2 Story**  
**15" Side Walls**

Door, Window, Room Addition and Chimney Placements

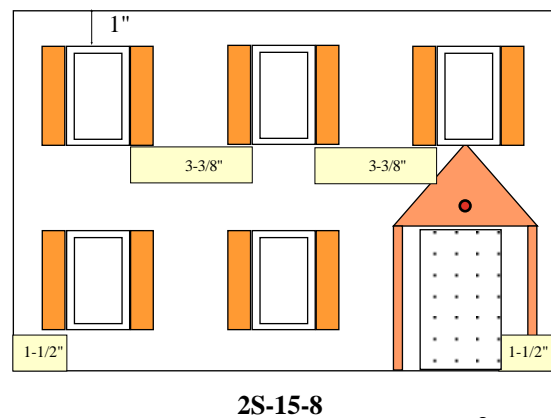
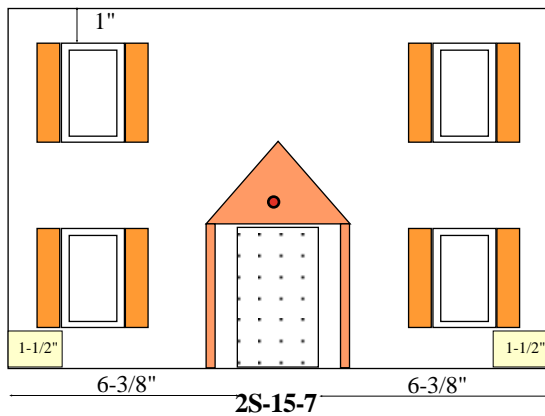
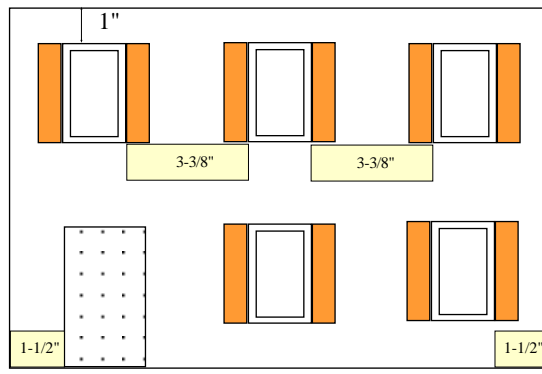
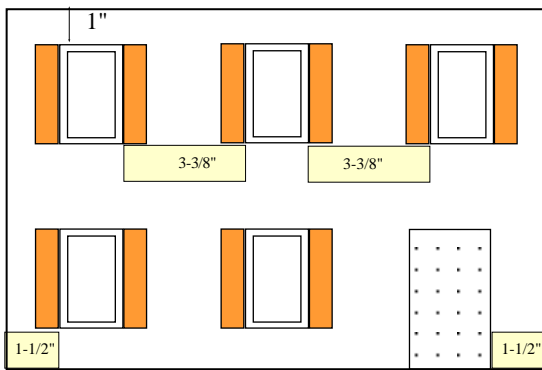
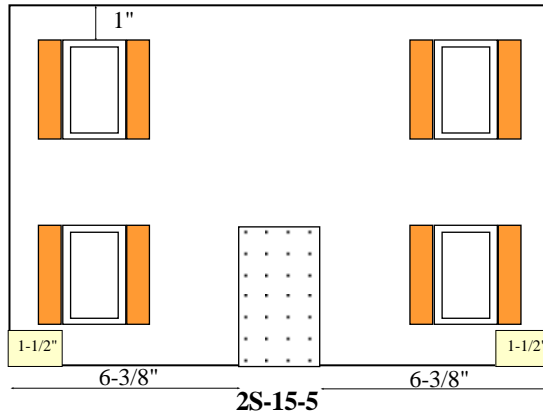

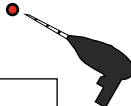

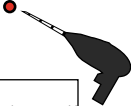
 Wall 2S-15-7  
 Drill a very small pilot hole through the wall to attach the porch back. Hole will be centered at  
 7-1/2" from each side and  
 4-3/4" above floorline

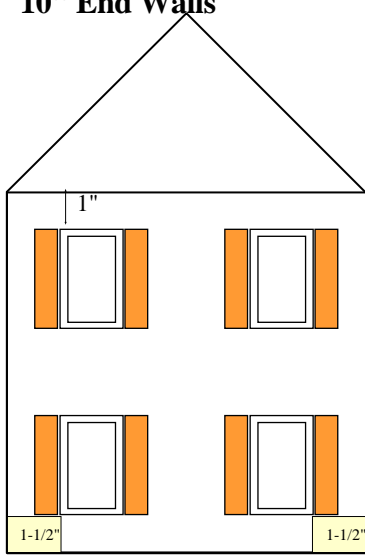

 Wall 2S-15-8  
 Drill a very small pilot hole through the wall to attach the porch back. Hole will be placed at  
 2-3/4" from the side and  
 4-3/4" above floorline

**2 Story  
 10" End Walls**

**Door, Window, Room Addition and Chimney Placements**

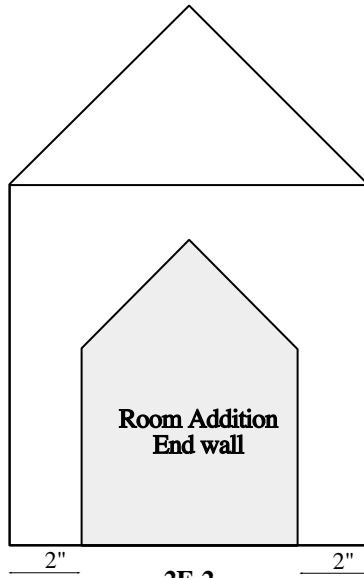

**2E-1**



**2E-2**

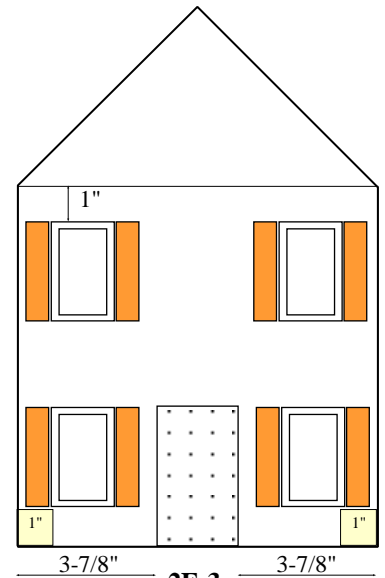

**2E-3**

Room Addition  
 Windows can not be  
 effectively  
 used on the house walls.  
 See Room Addition  
 walls for options.

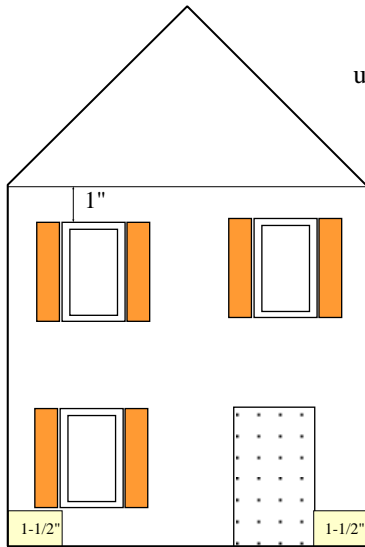

**2E-4  
 RH Door**

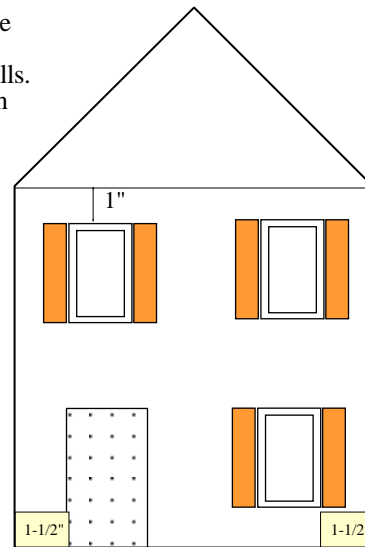

**2E-4  
 LH Door**

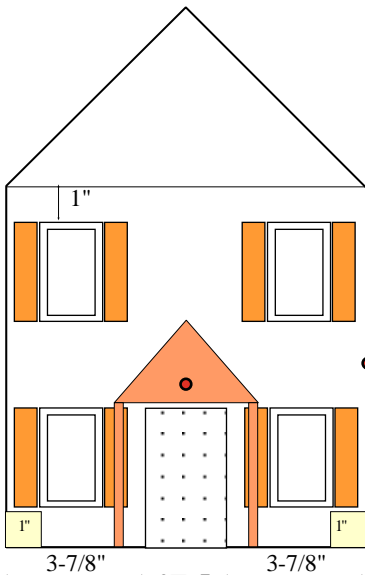

**2E-5**

Wall 2E-5  
 Drill a very small pilot hole through the  
 wall to attach the porch back. Hole will be  
 centered at  
 5"  
 from each side and  
 4-3/4" above floorline

Wall 2E-6  
 Drill a very small pilot hole through the  
 wall to attach the porch back. Hole will be  
 placed at  
 2-5/8" from the side and  
 4-3/4" above floorline

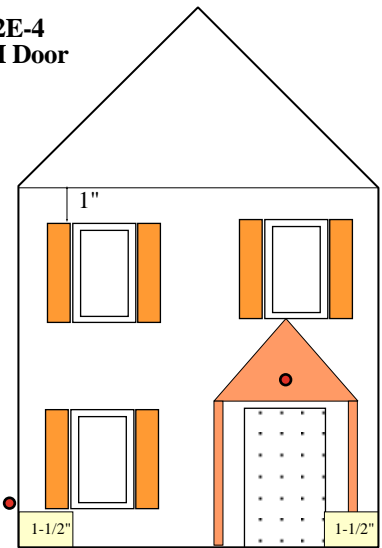

**2E-6**

**Roof top  
Chimney**

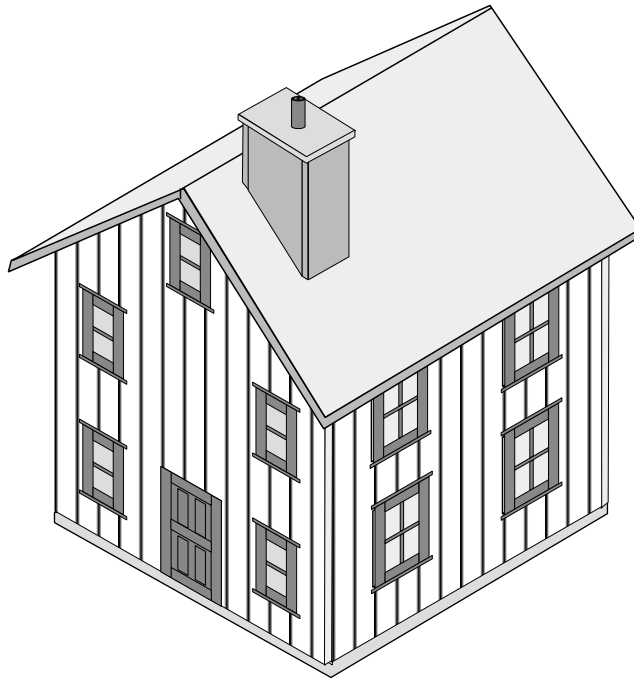

**Ground Level  
Chimney**



**Patterns**

**Rooftop Chimney  
 use with  
 Top and Dowel**

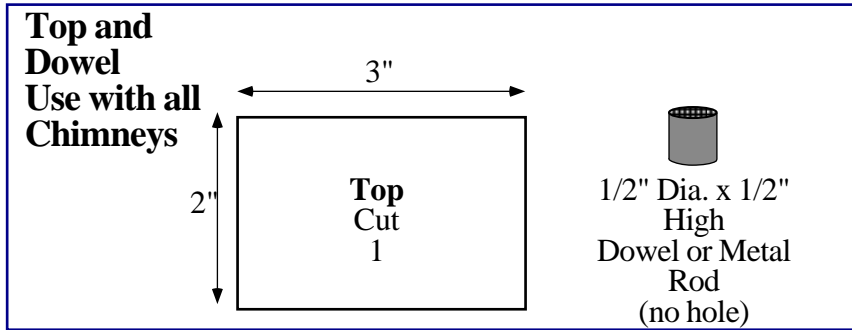
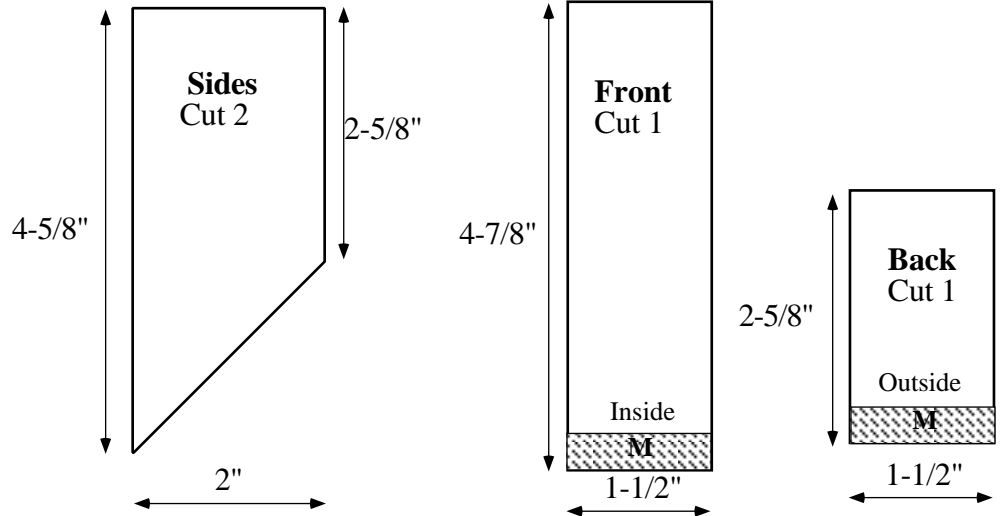

**Ground Chimney  
 use with  
 Top and Dowel**

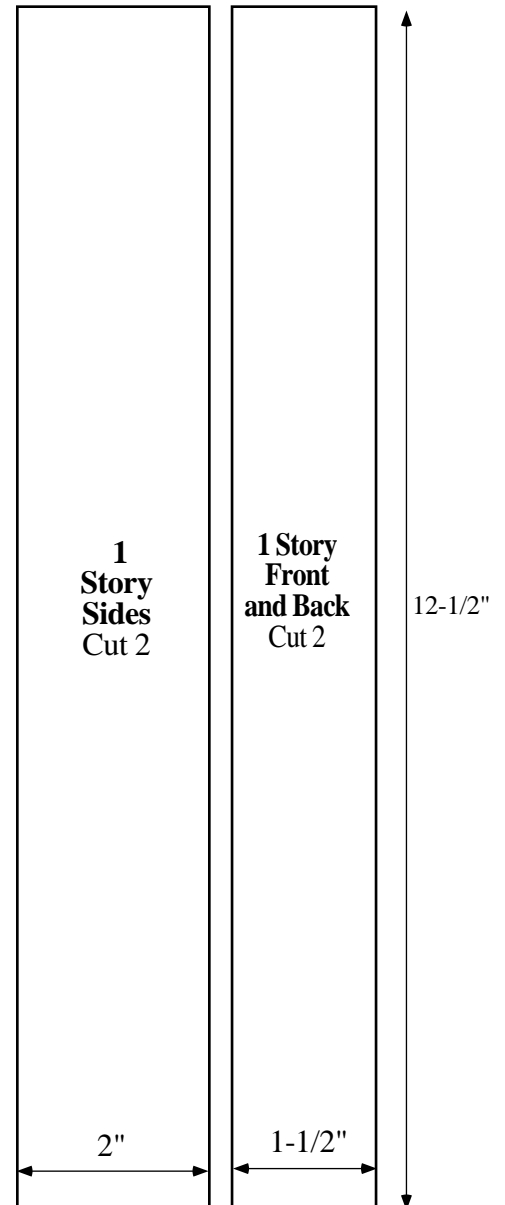
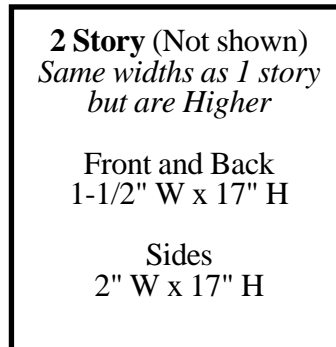
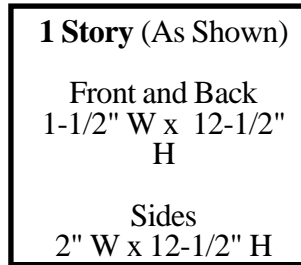



**Assembly**

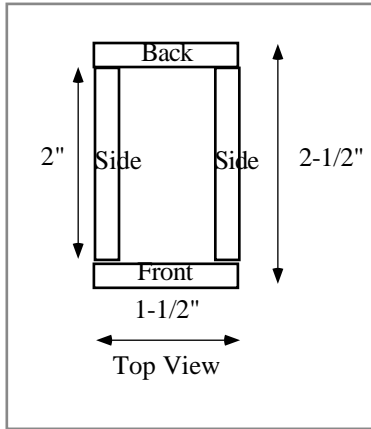

Note that the Sides are assembled inside of the Front and Back. This will form a 1-1/2" x 2-1/2" chimney.

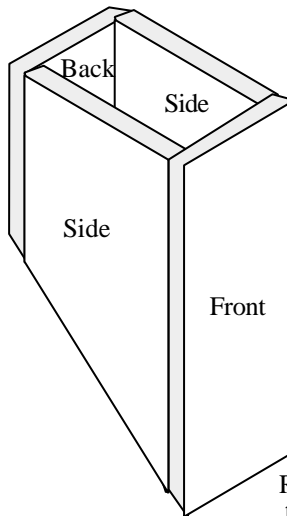

Run a bead of wood glue down the seams and securely nail or staple the chimney to form a box. Hint: You may want to clamp the wood in place before nailing.

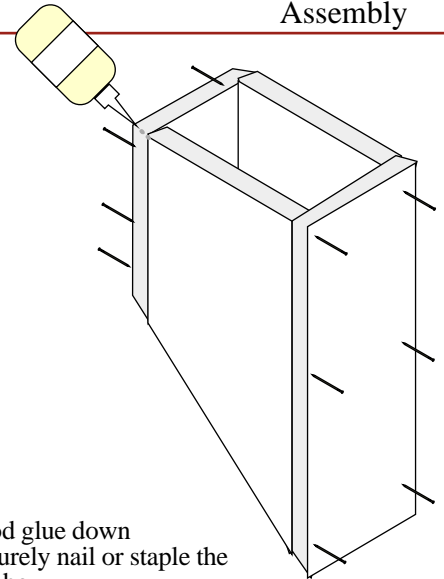

**All Tops**

2" X 3" with 1/2" diameter x 1/2" high dowel or metal rod (no hole) painted black. If building is to be used outside, you won't want rain water to run down a hole into the chimney.

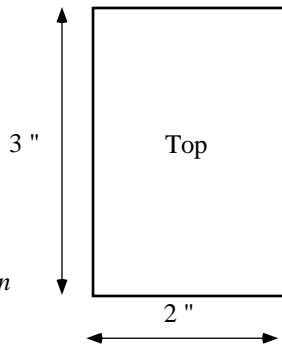

The Top will have an overhang of 1/4" on all sides.

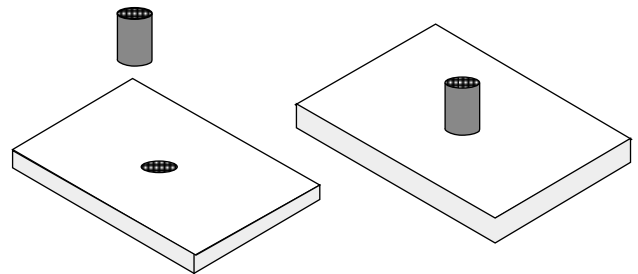

Drill a 1/2" hole in the center of the chimney top. Check to see that the rod will fit. It should be tight. Place a dab of glue inside the rim of the hole and insert dowel or rod.

Center and add the Top to the Chimney walls. Glue and nail or staple in place.

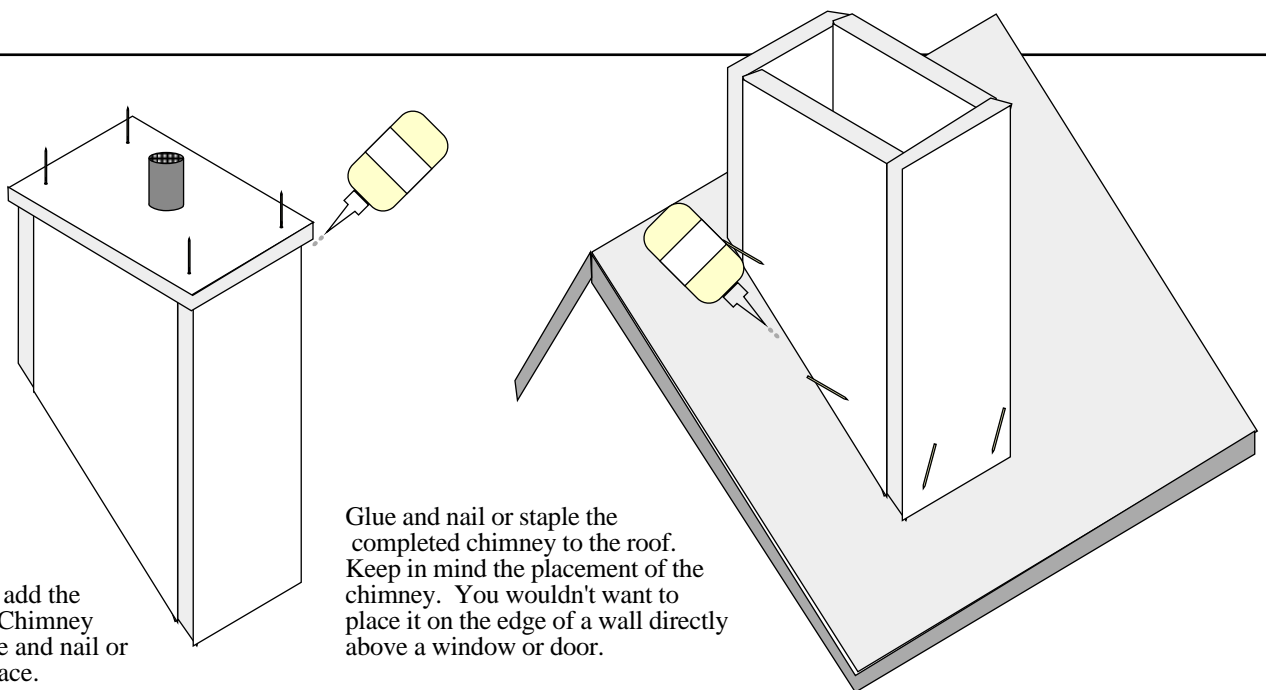

Glue and nail or staple the completed chimney to the roof. Keep in mind the placement of the chimney. You wouldn't want to place it on the edge of a wall directly above a window or door.

**Assembly** **Ground Level Chimney**  
 The ground level chimney is assembled exactly the same as the rooftop chimney except there is no mitering.

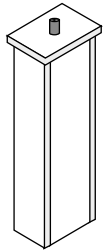

In order to get the chimney to fit up against the building, you will have to cut out a space on your roof for the chimney to slide into. Cut this notch before assembling the roof. Measure and mark where you want your chimney. This will be in the same position vertically as the foundation addition for the chimney.

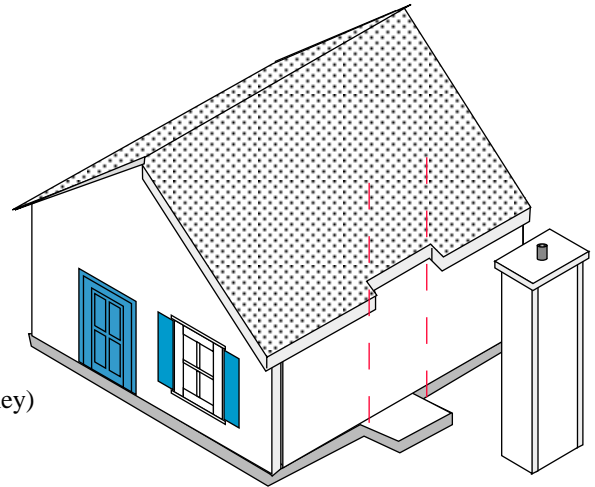

The notch will be 2-1/2" wide (width of the chimney) x 1/2" deep (or the depth of the overhang.) You may have to sand a little off to get a snug fit.

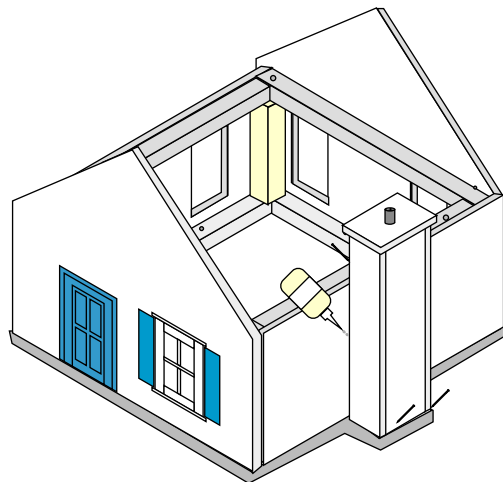

The Chimney should be installed against the house before attaching the roof. Use your wood glue and nail or staple chimney in place to the side walls (from inside of house) and the foundation.

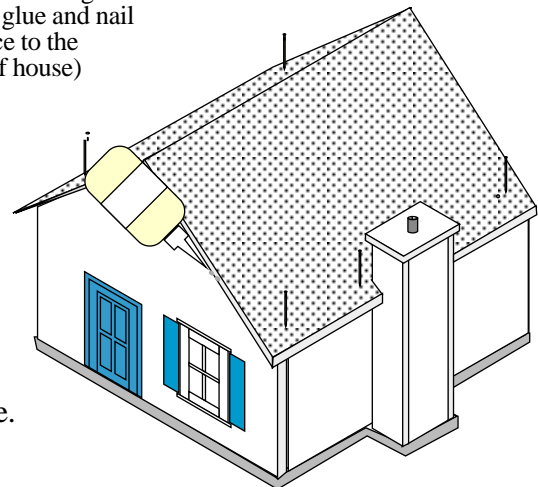

Add the roof and attach in place.

**Optional ideas**

Experiment with some scrap pieces before you begin on your chimney.

1. If so inclined, you could use a bit of ready mix concrete (just add water) which is usually used for patching. Rough up the sides and the top of the chimney and cover them with a thin film of the concrete. You may have to let it dry and go over it a couple of times in thin films to build up the desired layer. The top could be "flat" (no pattern) You can use an old sponge, brush, towel or whatever to brush the damp concrete for a rough finish or a specific pattern. The concrete can be painted or left natural.

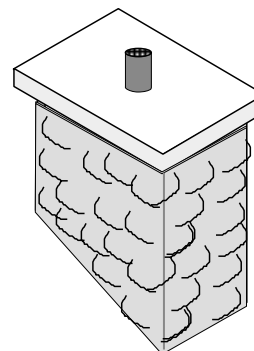

2. Gather up some small stones or pebbles of like sizes and using epoxy, attach them to the chimney sides. Fill in the "gaps" with a thin layer of concrete, let dry for a little bit and brush the residue off the stones before it hardens. Cover the top piece with a layer of the concrete.

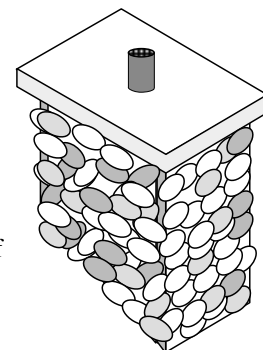

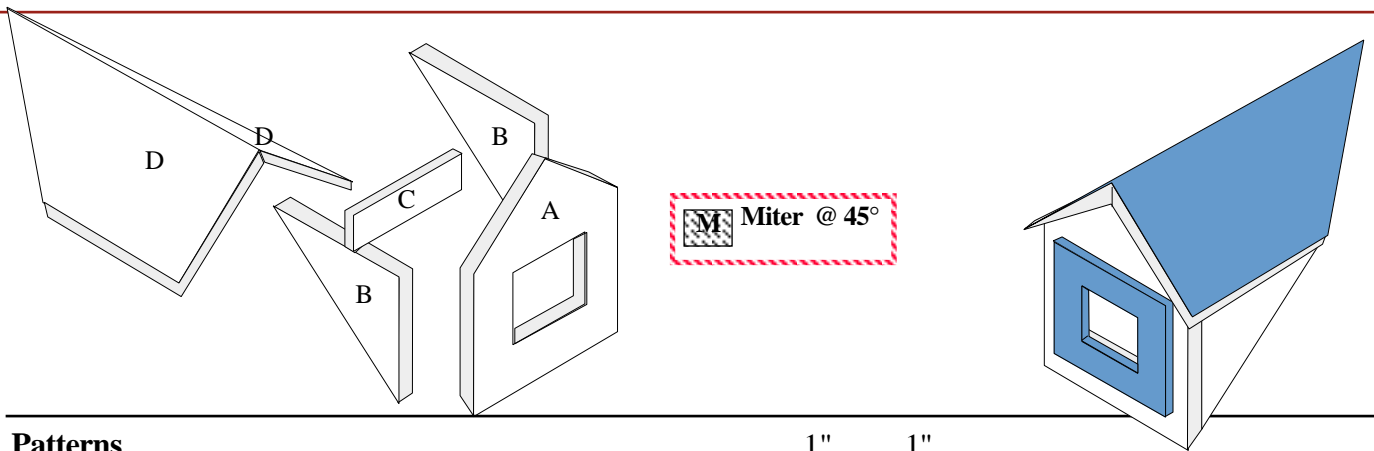

**Patterns**

A - 2" Wide x 3" High (center) and 2" High (side)

- Begin with a rectangle 3" High x 2" Wide
- Measure and mark the top center (1" from each side)
- Measure and mark 2" up from the bottom on both sides
- With ruler, draw your lines between the x's, forming the roof line.
- Cut out 1 End Wall
- Cut out window opening prior to assembly (See Dormer Window)

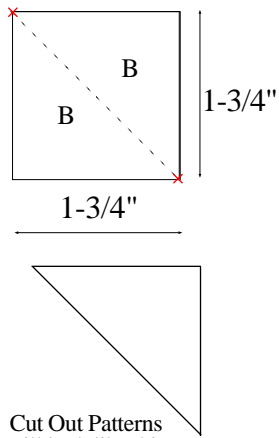
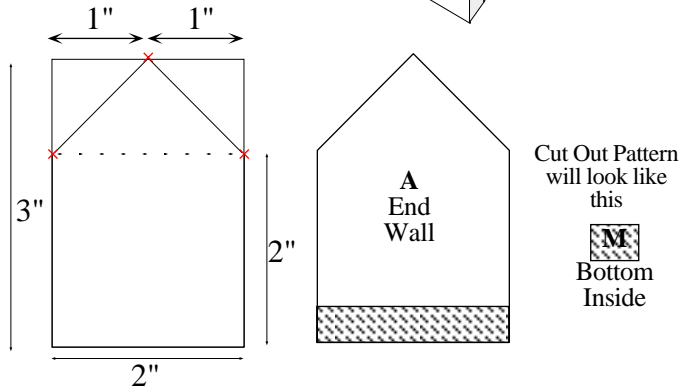

**B - Dormer Sides**

- Begin with a rectangle 1-3/4" High x 1-3/4" Wide
- With ruler, draw an angle from the top Left Hand Corner to the bottom Right Hand Corner.
- Cut out 2 Side Walls
- The two halves will make 2 side walls*

**C - Inside Brace**  
 1/2" x 1-1/2"  
 Cut 1

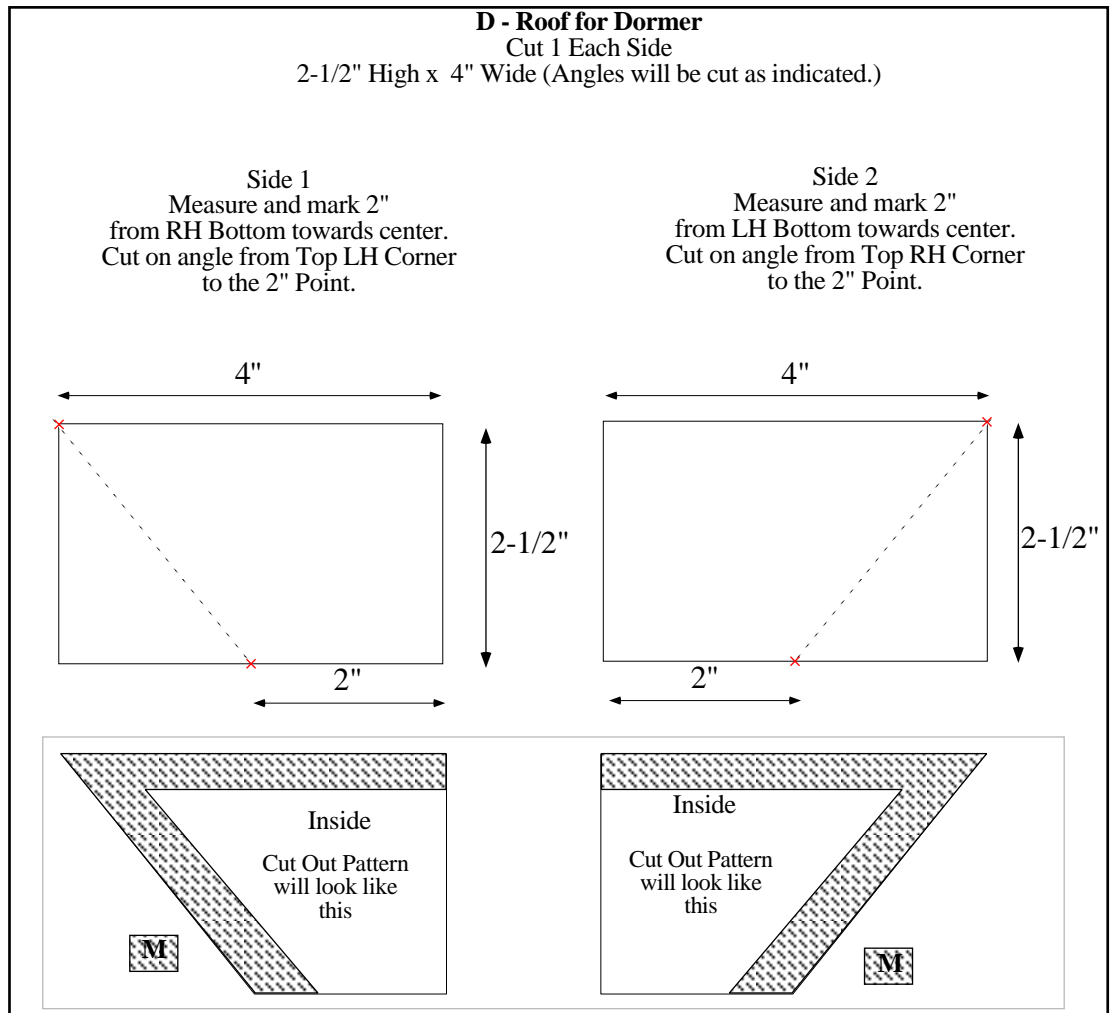

**Assembly**

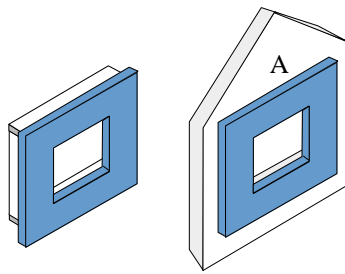

Front

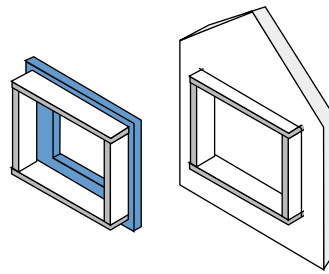

Back

1. Window opening will have to be cut prior to assembly. It will probably be easier if you also go ahead and install the window, as it should be in place prior to adding the roof.

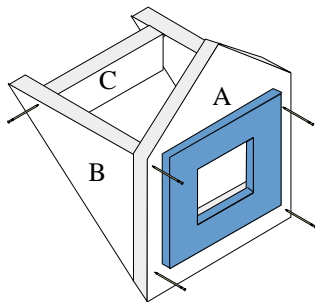

2. Note part A (End) is assembled on the outside of part B (Sides). Part C (brace) fits inside the sides. Lightly Glue and nail or staple the sides, end and brace together as illustrated.

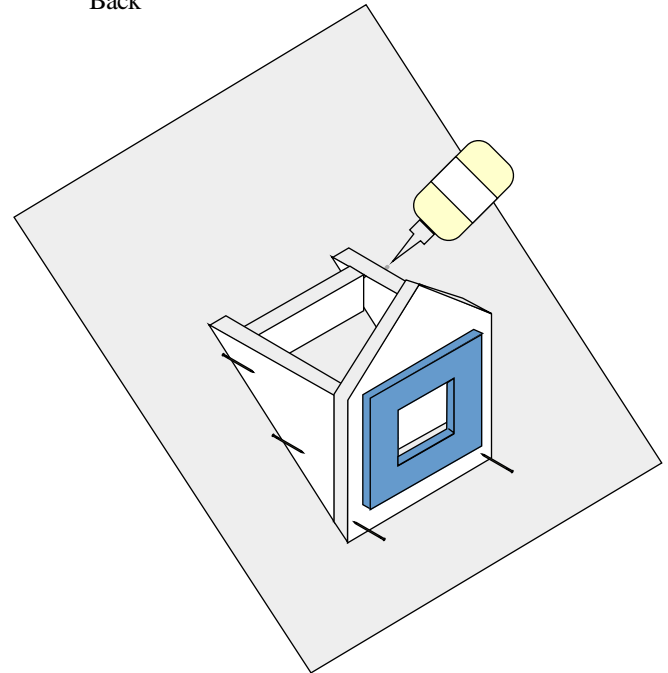

3. Attach the dormer to the roof of the house, again using a light bead of glue and nails or staples. Run a bead of glue along the top exposed wood of the dormer, where the roof will fit.

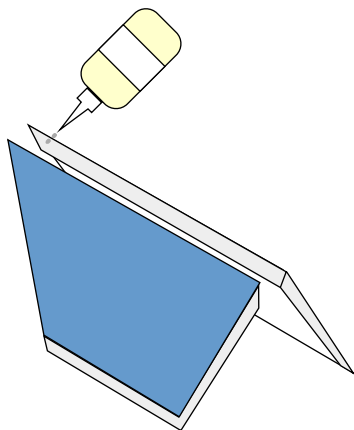

4. Run a bead of Wood Glue along the top inside mitered sides of the dormer roof.

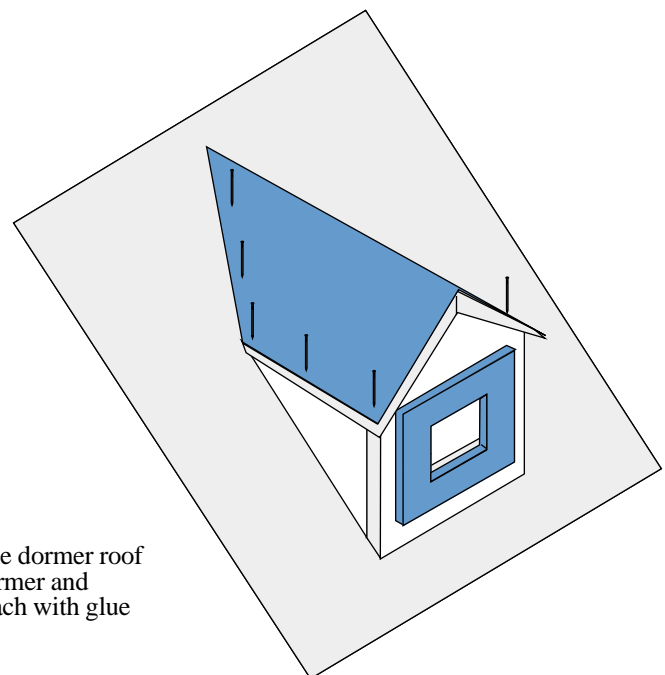

5. Center the dormer roof on to the dormer and securely attach with glue and nails.

Can be used with  
 1 Story building (end wall only)  
 or  
 2 Story building. (any wall).

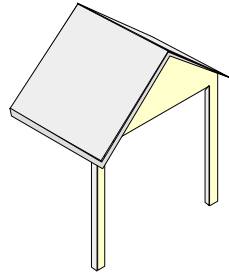

**Patterns**

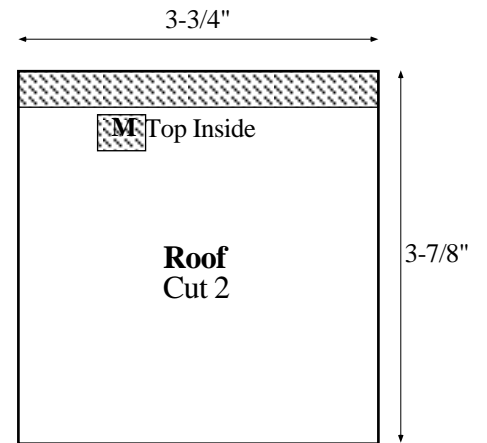
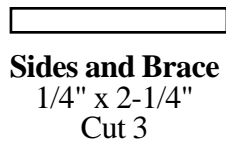
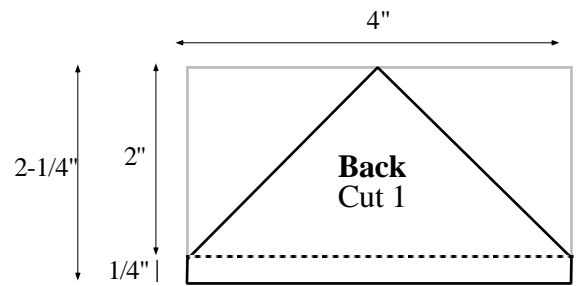
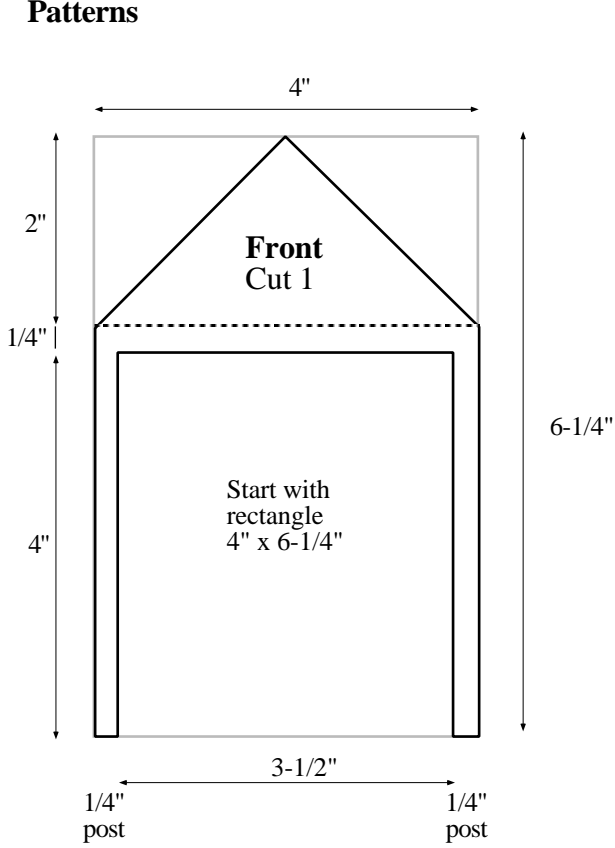

**Assembly**

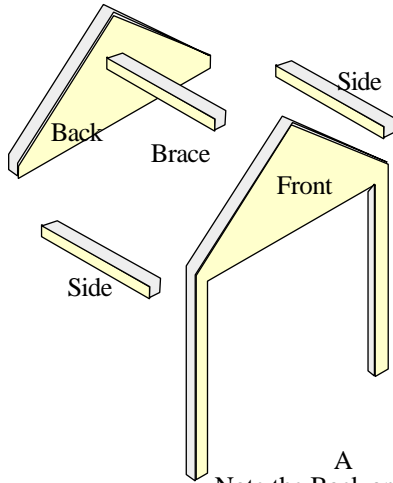

**A**  
 Note the Back and Front  
 are assembled on the outside  
 of the Sides and Brace.  
 Glue and nail porch as shown.

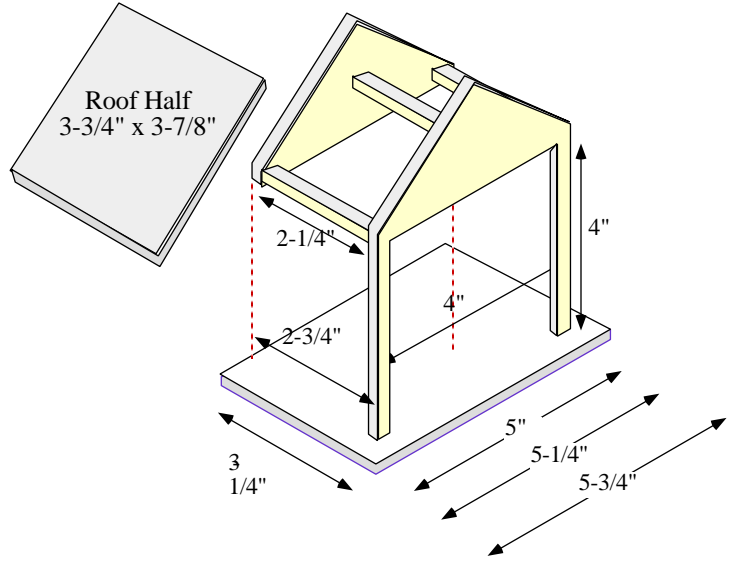

Base is added to the foundation  
 Length According to Placement on wall  
 Any wall porch centered 3-1/4" x 5"  
 End Wall - porch to the side 3-1/4" x 5-1/4"  
 Side Wall - porch to the side 3-1/4" x 5-3/4"

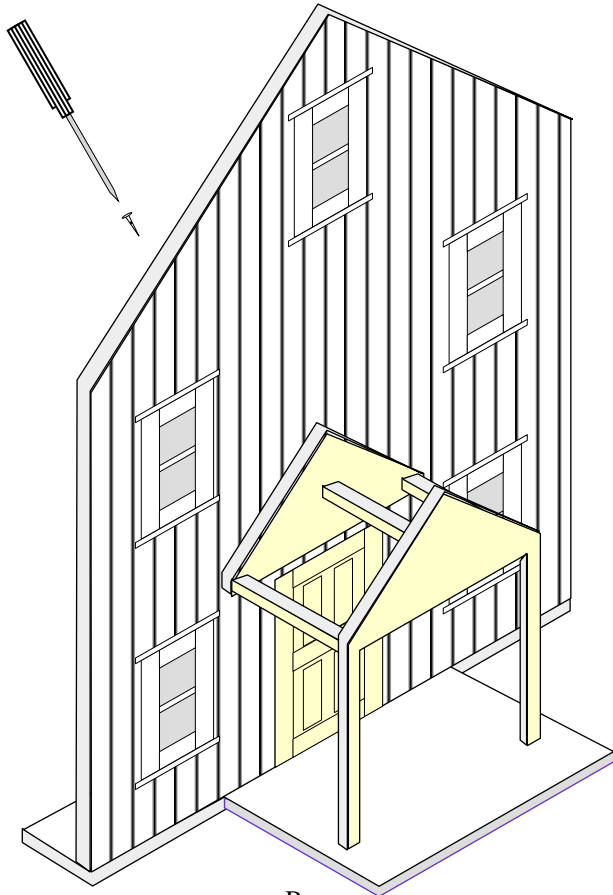

**B**  
 Glue the back of the porch frame.  
 From the inside wall, put a small  
 screw through the pilot hole into  
 the porch frame to secure porch.

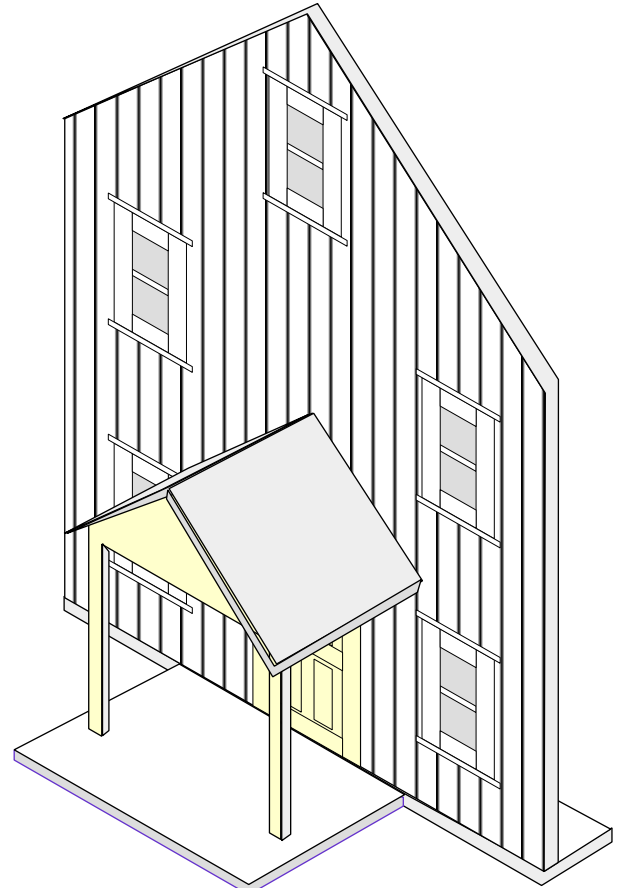

**C**  
 Carefully center  
 and glue roof onto porch as shown.

Cut from 1/4" Plywood

**1 Story End Walls**

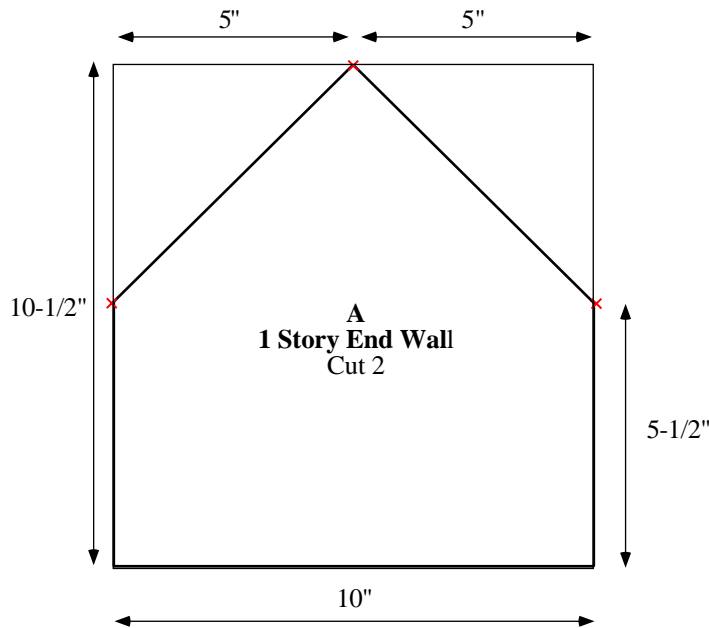

**End Wall**

- Begin with a rectangle 10-1/2" High x 10" Wide
- Measure and mark the top center (5" from each side)
- Measure and mark 15-1/2" up from the bottom on both sides
- With ruler, draw your lines between the x's, forming the roofline
- Cut out two End Walls

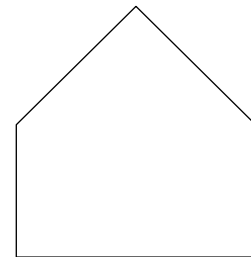

Cut-out End Wall  
will look like this

**1 Story Side Walls**

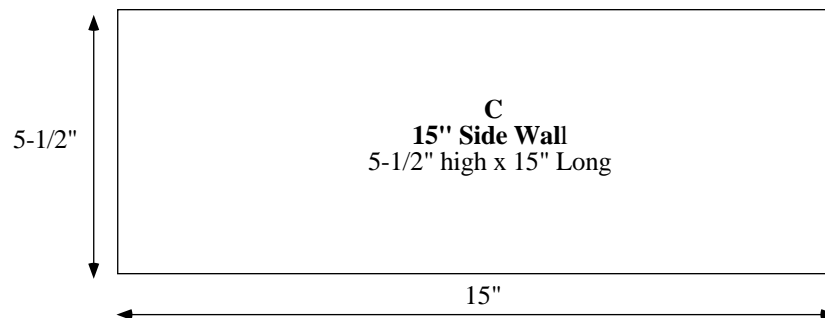

**Cut from 1/4" Plywood**

**2 Story End Walls**

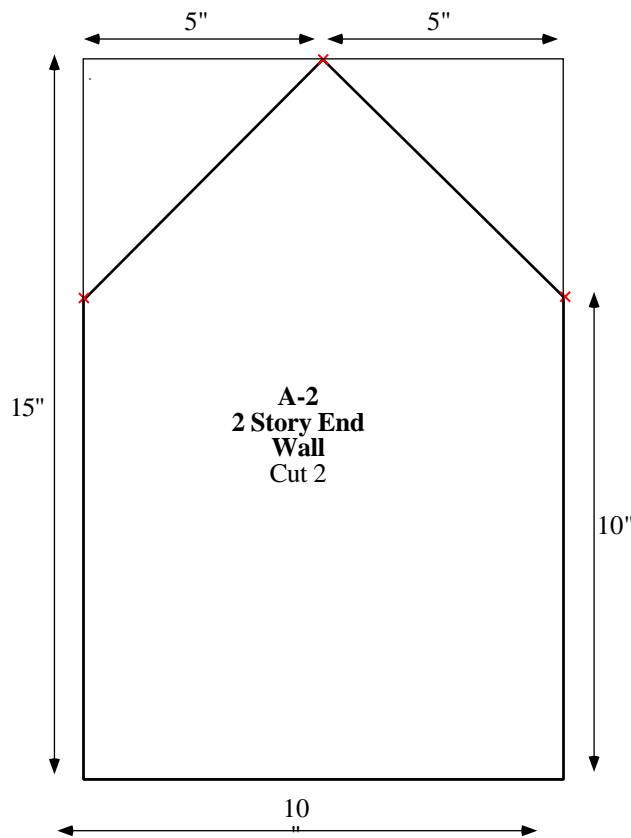

**End Wall**

- Begin with a rectangle 15" High x 10" Wide
- Measure and mark the top center (5" from each side)
- Measure and mark 10" up from the bottom on both sides
- With ruler, draw your lines between the x's, forming the roofline.
- Cut out two End Walls

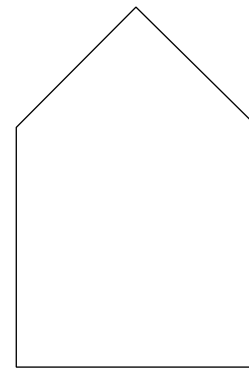

Cut-out End Wall will look like this

**2 Story Side Walls**

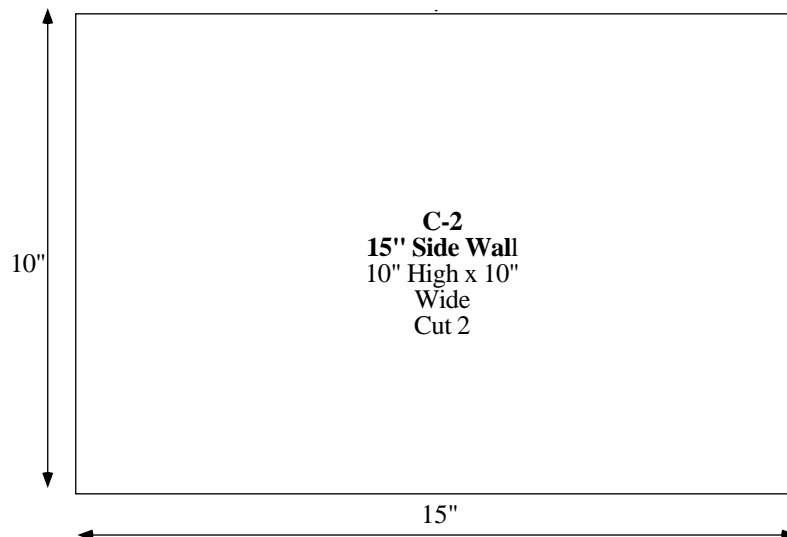



**Cut from 1/4" Plywood**

**Roofs for 1 or 2 Story Houses**  
**15" Sidewalls - Choose 2 Halves, as required**

**M** Miter @ 45°  
 \*\*\*See Before You Begin - Hints and Tips  
 Two Ways to Assemble 45° Roofs  
 For non-mitered roof, add 1/4" to height for one roof half only

Plain Roof Halves

For 1 or 2 Story Side Walls  
 with no ground type chimney

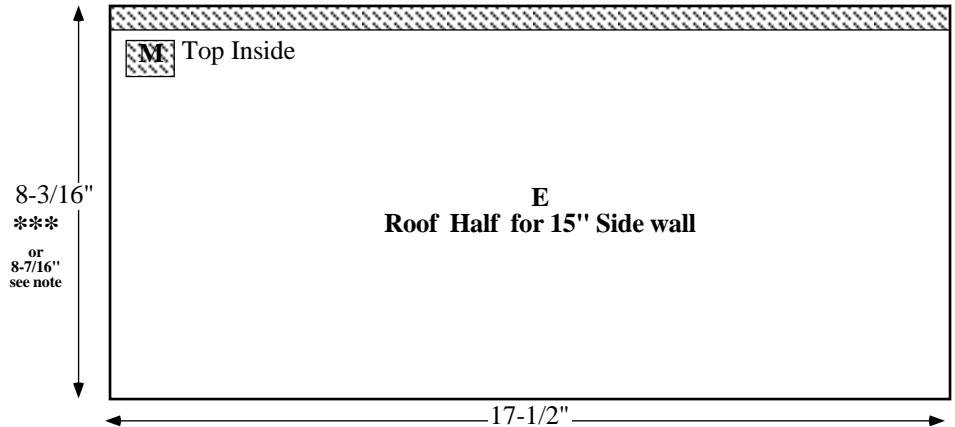

For 1 or 2 Story Side Wall  
 with offset Ground Chimney

Make the notch 2-1/2" wide and 1/2" deep  
 You may have to trim a bit more when  
 actually fitting the chimney in place. .

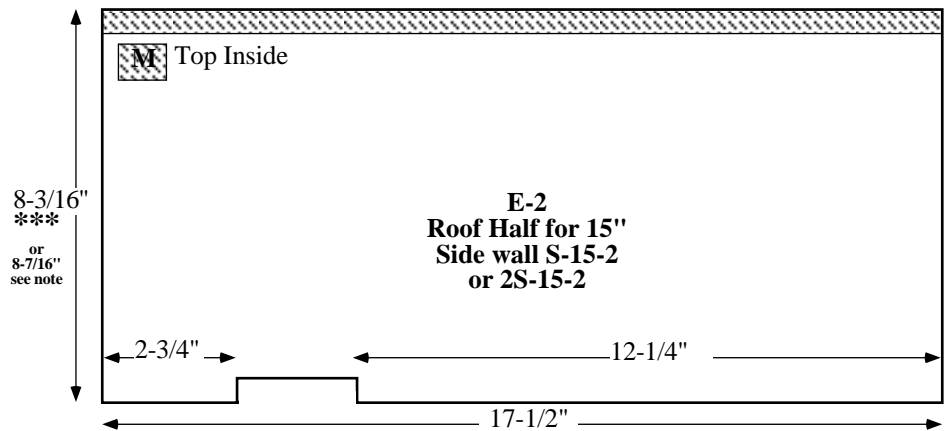

For 1 or 2 Story Side Wall  
 with centered Ground Chimney

Make the notch 2-1/2" wide and 1/2" deep  
 You may have to trim a bit more when  
 actually fitting the chimney in place. .

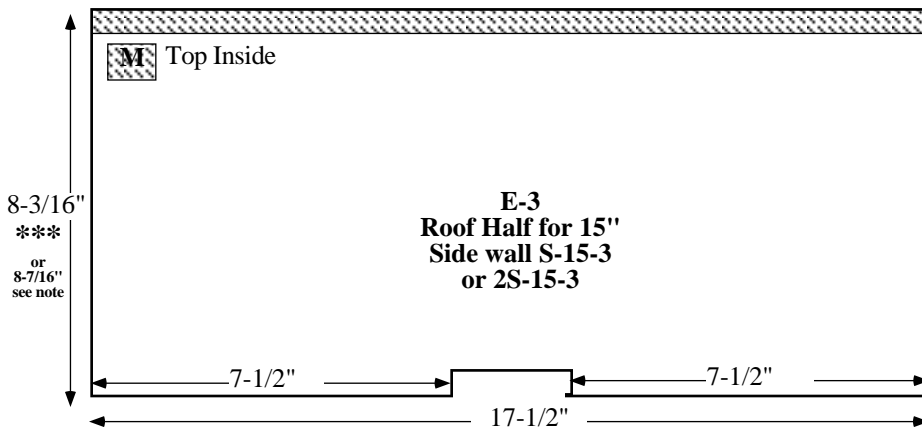

Cut from 1/4" Plywood

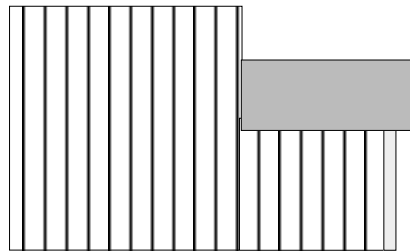

**Room Addition**  
 Use with 1 or 2 Story End Wall  
 or 2 Story Side Wall

**Room Additions**  
 Side Walls and End Wall

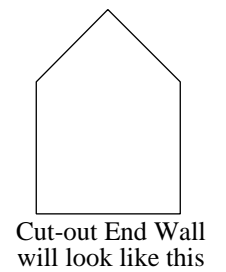
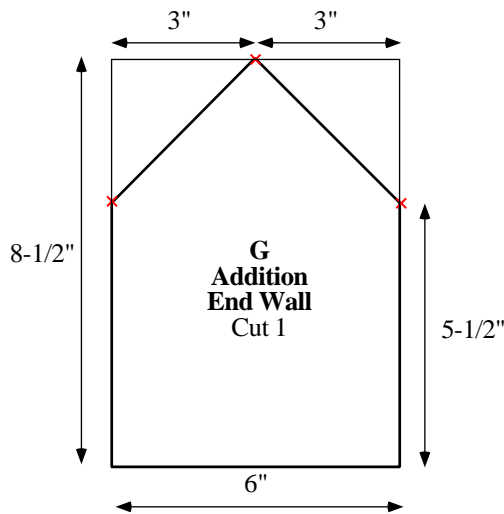
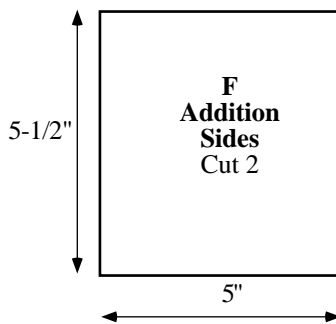

- End Wall**
- Begin with a rectangle 8-1/2" High x 6" Wide
  - Measure and mark the top center (3" from each side)
  - Measure and mark 5-1/2" up from the bottom on both sides
  - With ruler, draw your lines between the x's, forming the roofline.
  - Cut out 1 End Wall

**Addition Roof**

**M** Miter @ 45°

\*\*\*See Before You Begin - Hints and Tips  
 Two Ways to Assemble 45° Roofs  
 For non-mitered roof, add 1/4" to height for one roof half only

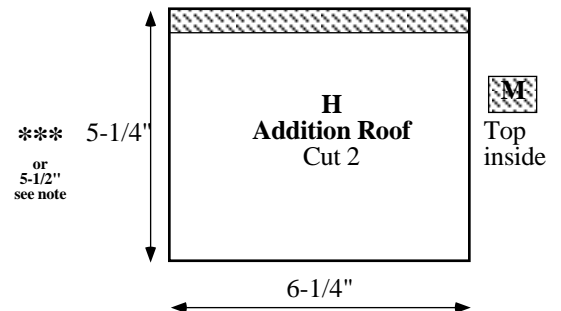

**The Foundations INFORMATION FOR ADJUSTMENTS IF REQUIRED**

All Additions (chimney, porch, and room) will fit on a 2 Story House. Because of the roof angle, a Room Addition or a Porch will not fit on a 1 Story House Side Wall. They will fit on an End Wall.

You can leave off any addition to the foundations if you wish to use a basic wall instead of one with an addition. Use the appropriate measurements which do not include the dimensions for the addition.

The Sample to the right is of Foundation 2, as shown in the patterns. The Samples below are adjustments to Foundation #2. Use the same technique with any of the foundations.

# 2  
 With All  
 Dimensions  
 Shown

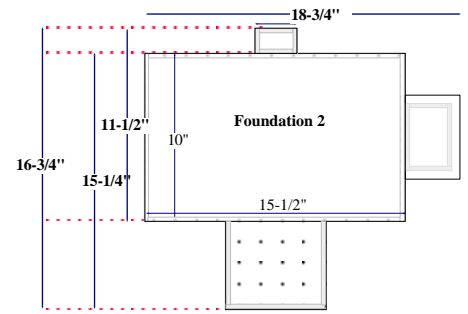

<p># 2                  With Chimney, Porch                  and Room Addition                  2 Story only 16-3/4" x 18-3/4"</p>	<p># 2                  With Chimney                  and Room Addition                  2 Story only 16-3/4" x 15-1/2"</p>	<p># 2                  With Porch                  and Room Addition                  2 Story only 15-1/4" x 18-3/4"</p>
<p># 2                  With Chimney and                  Porch on End Wall                  1 Story or 2 Story                  11-1/2" x 18-3/4"</p>	<p># 2                  With Chimney                  1 Story or 2 Story                  11-1/2" x 15-1/2"</p>	<p># 2                  With Porch on End Wall                  Use with 1 Story or 2 Story                  10" x 18-3/4"</p>

**Foundation Patterns**

Note:  
 Side Walls are assembled  
 inside of the End Walls.  
 Illustration shows wall placement  
 inside the foundation.

**1** Basic Foundation

Foundation # 1 for 1 Story or 2 Story Houses which do not have any additions.

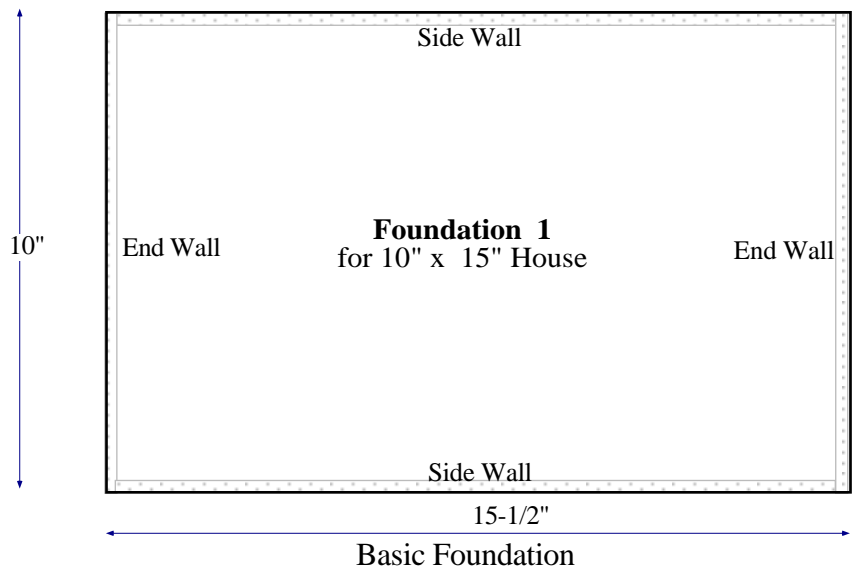

# 2

**For 1 Story House**  
 begin with rectangle  
 11-1/2" x 18-3/4"  
 (Leave off  
 Room Addition  
 Foundation)

**For 2 Story House**  
 begin with rectangle  
 16-3/4" x 18-3/4"

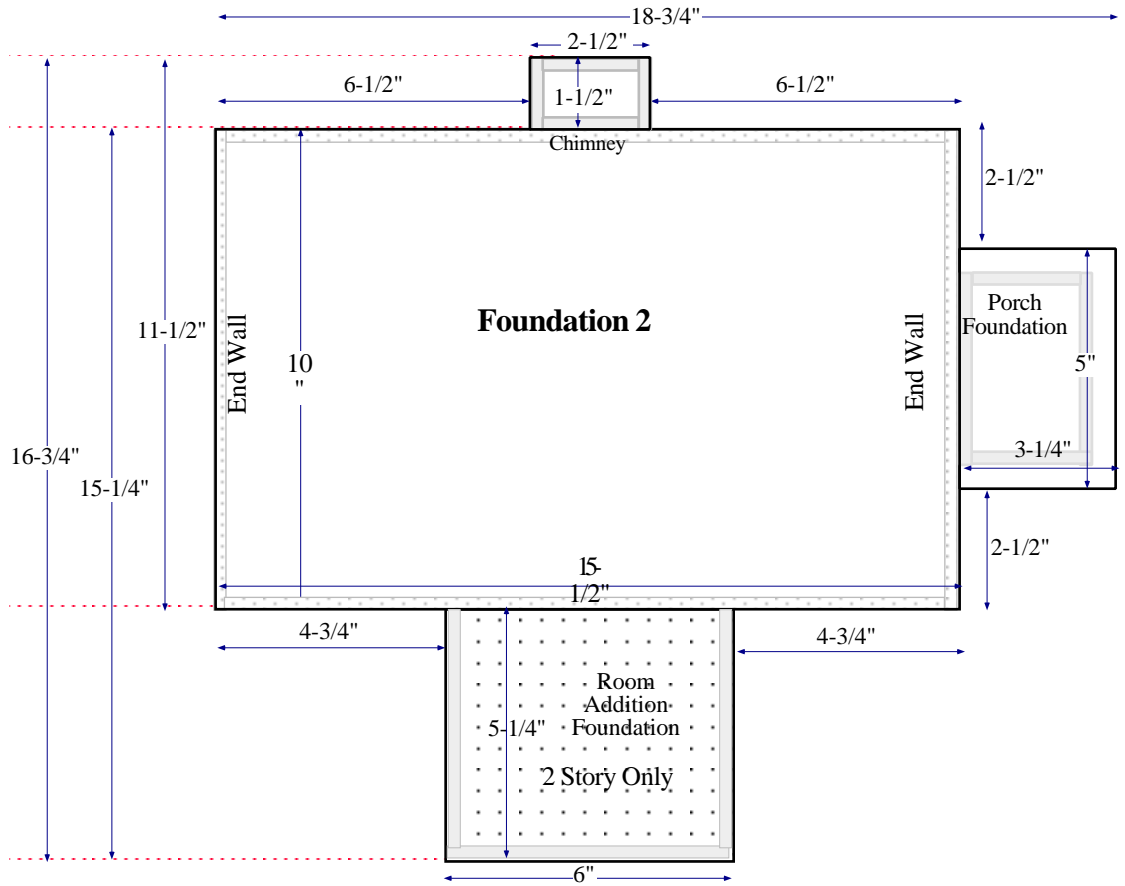

# 3

**For 1 Story House**  
 begin with rectangle  
 11-1/2" x 18-3/4"  
 (Leave off  
 Room Addition  
 Foundation)

**For 2 Story House**  
 begin with rectangle  
 16-3/4" x 18-3/4"

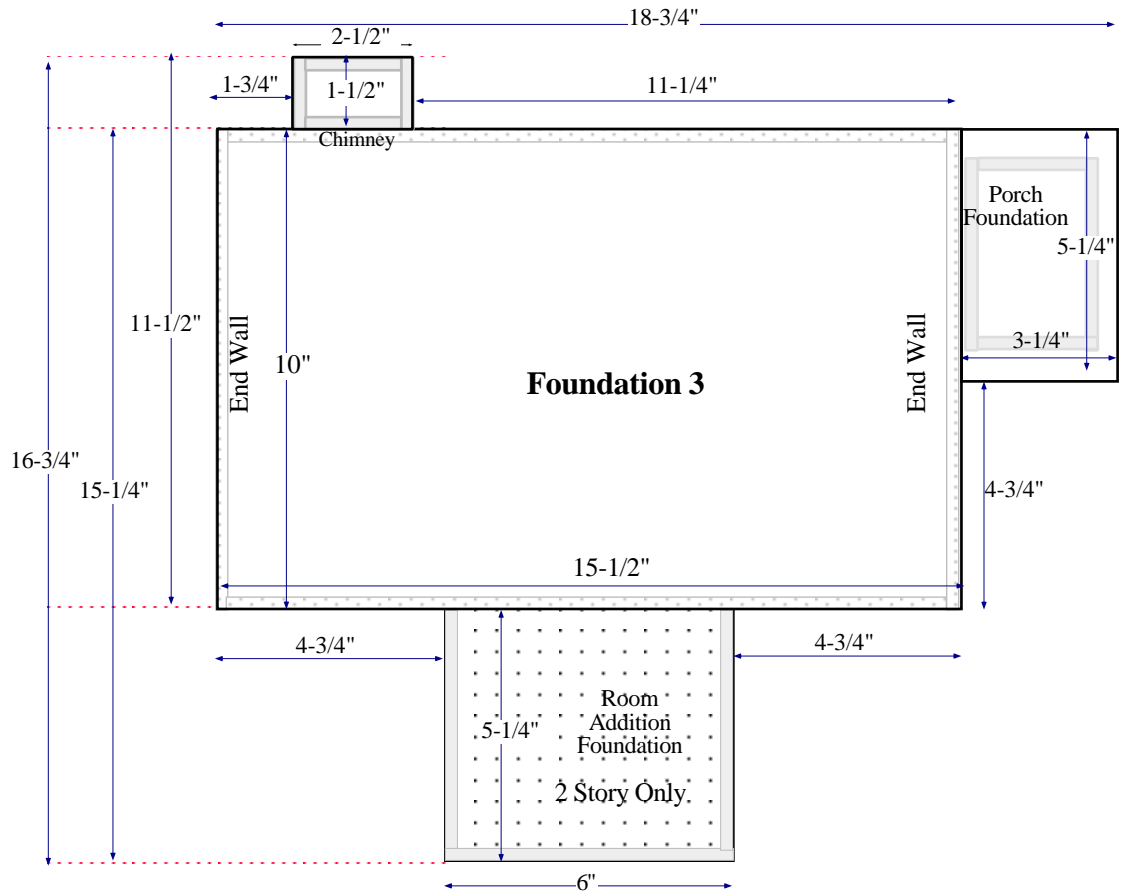

4

**For 1 Story House**  
 begin with rectangle  
 10" x 20-3/4"  
 (Leave off  
 Porch Foundation)

**For 2 Story House**  
 begin with rectangle  
 13-1/4" x 20-3/4"

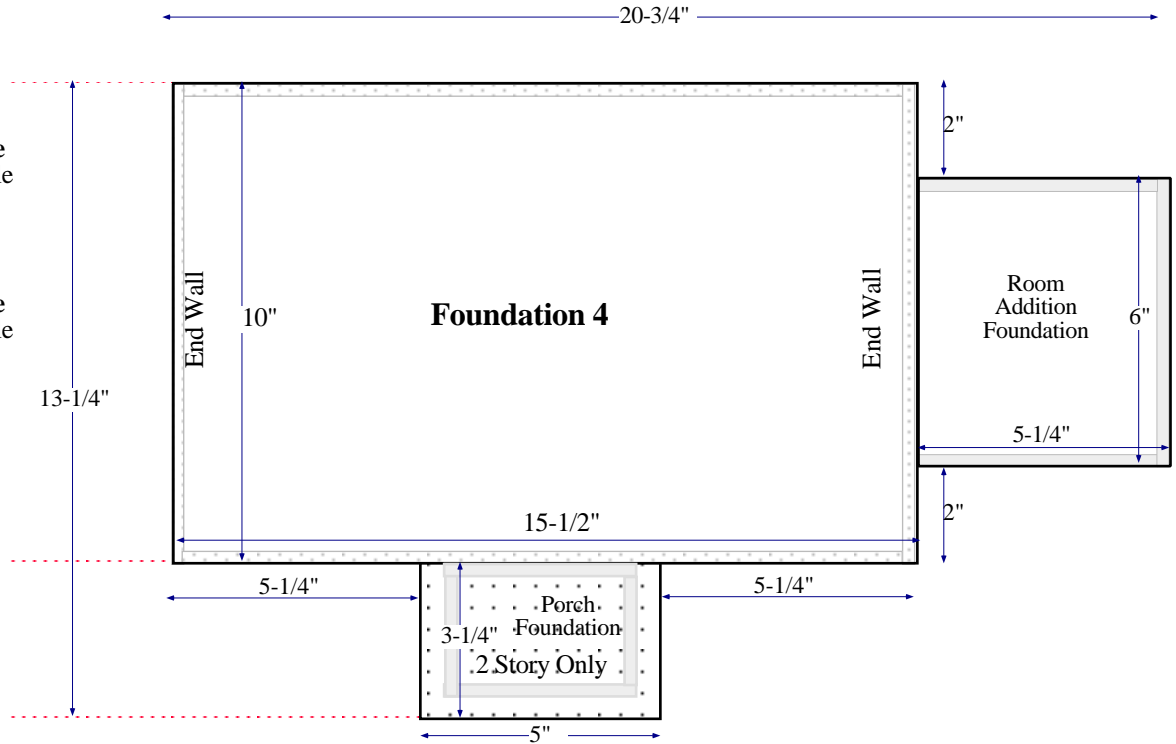

5

**For 1 Story House**  
 begin with rectangle  
 11-1/2" x 20-3/4"  
 (Leave off  
 Porch Foundation)

**For 2 Story House**  
 begin with rectangle  
 14-3/4" x 20-3/4"

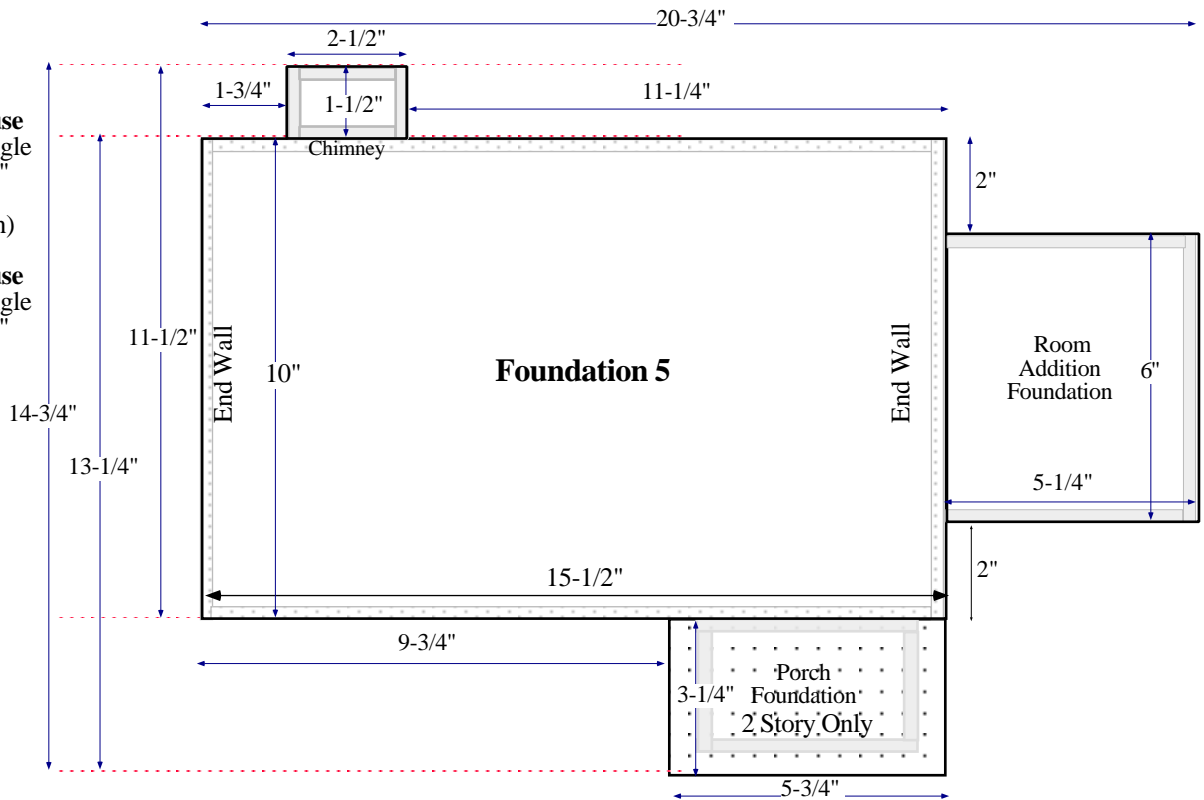

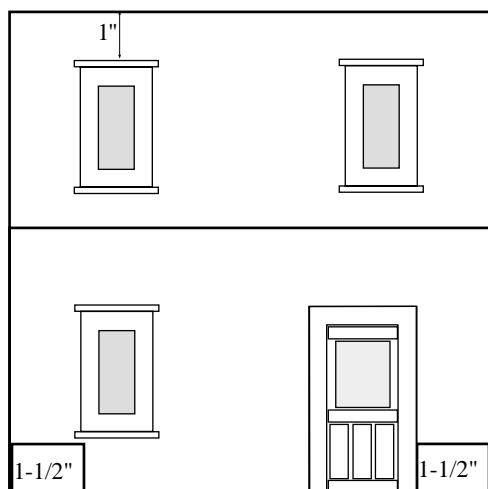
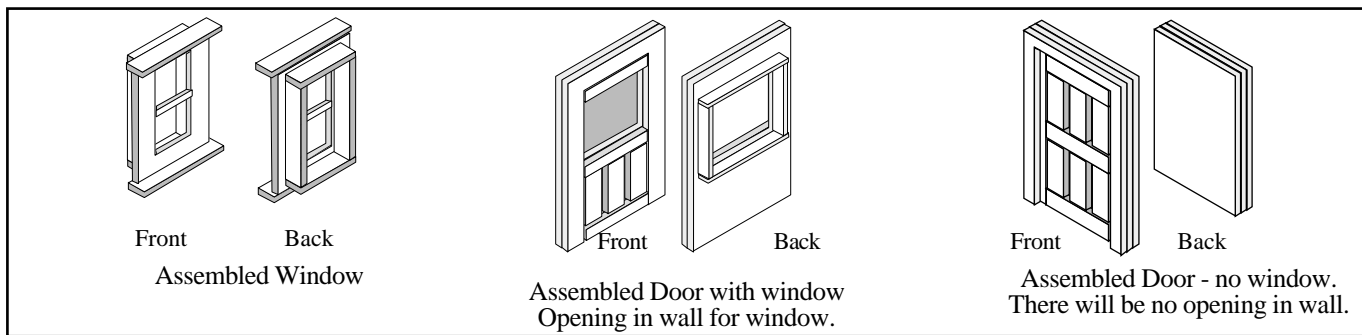

Decide where you want to place door and windows on the cut-out wall

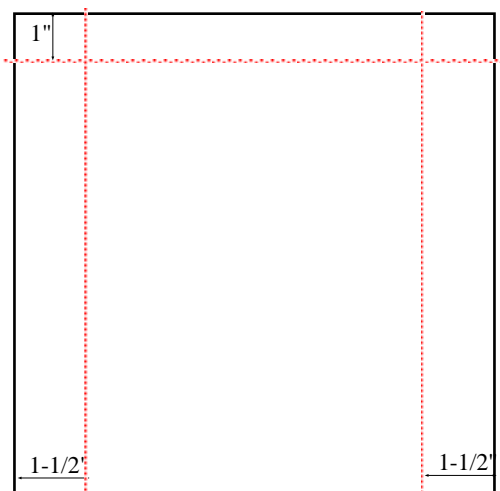

With pencil and ruler, lightly draw guide lines on the wall.

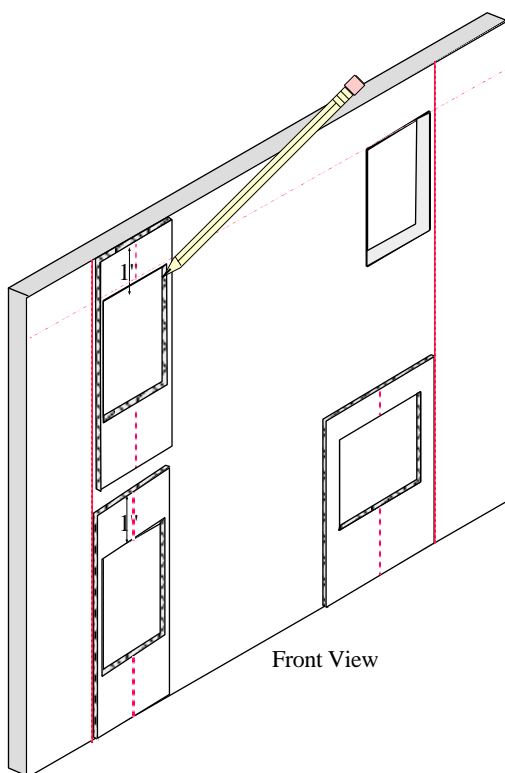

### Template for Window Opening in Wall

**Important:** After you cut your template check that your sizes and openings are accurate according to the dimensions noted. Use a ruler to check. You can take a finished window or door and make sure that it physically fits into the template opening.

Using your side guide lines, place the template as follows.

- Ground floor:**  
Bottom of template will be on bottom of wall
- 2nd floor**  
Top of template will be on top of wall

Using template and pencil, mark the window opening on the building. Cut out opening on building. The opening is now ready for the finished door or window.

Note: Doors and windows should be painted or stained before you actually insert and secure them into the building. Before gluing windows, check to see that they will easily fit the wall openings. Trim openings if necessary.

**Walls should be assembled and painted prior to installing doors and windows.**  
 See page 44

Place some wood glue on the flat backs of the finished window and door with window. (around the frame) This will adhere to the front of the wall.

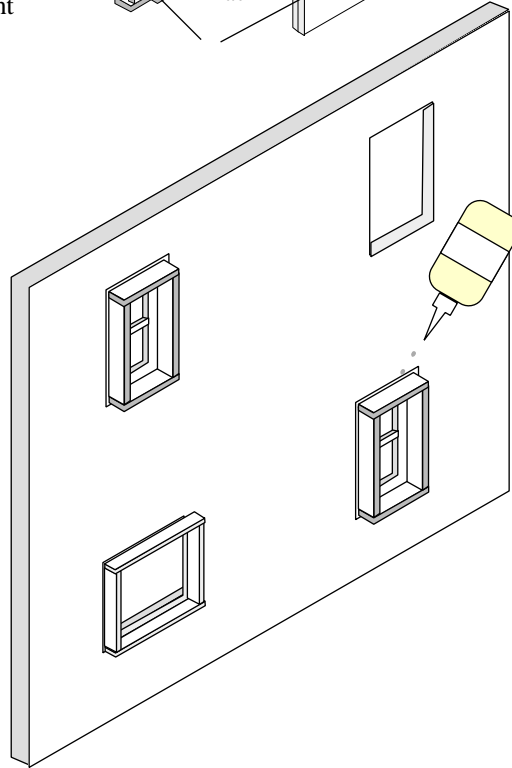
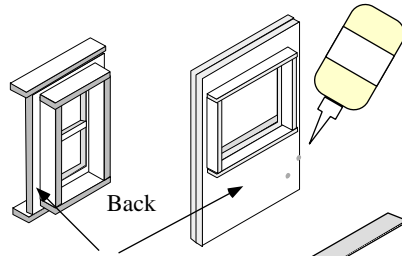

Insert the glued window or door with window into the appropriate wall opening. Look at the front side and using a level, make sure the window is straight. Run a bead of wood glue around the window brace. Allow the glue to dry.

Back View

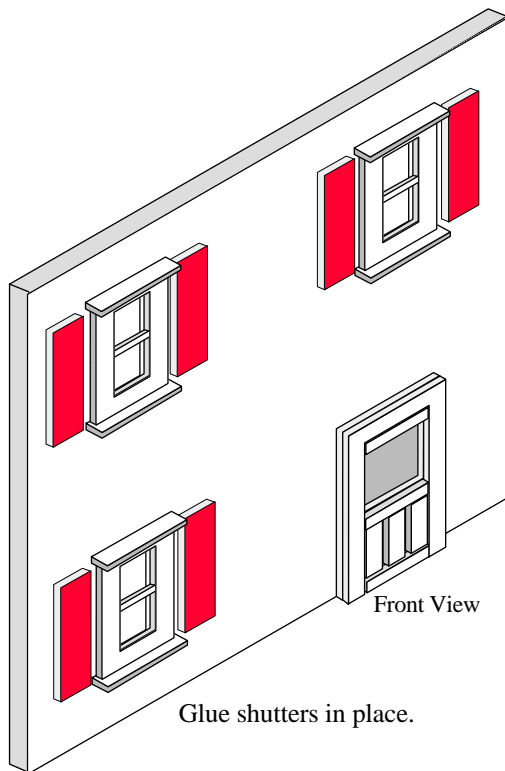

Glue shutters in place.

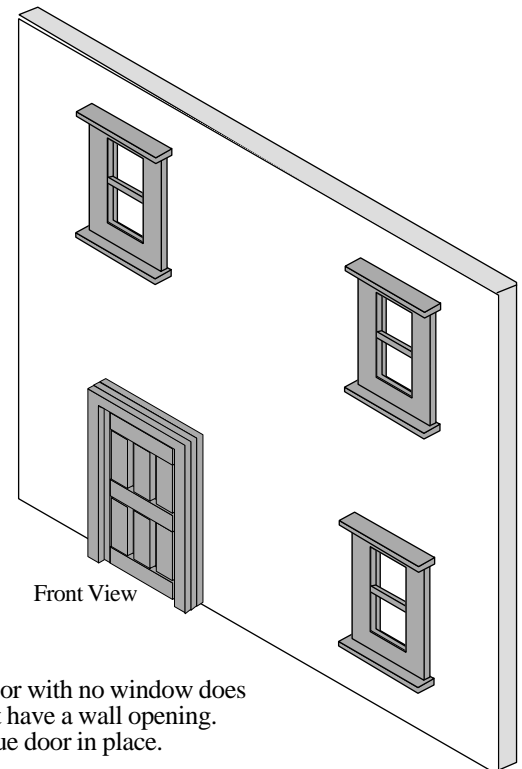

Door with no window does not have a wall opening. Glue door in place.

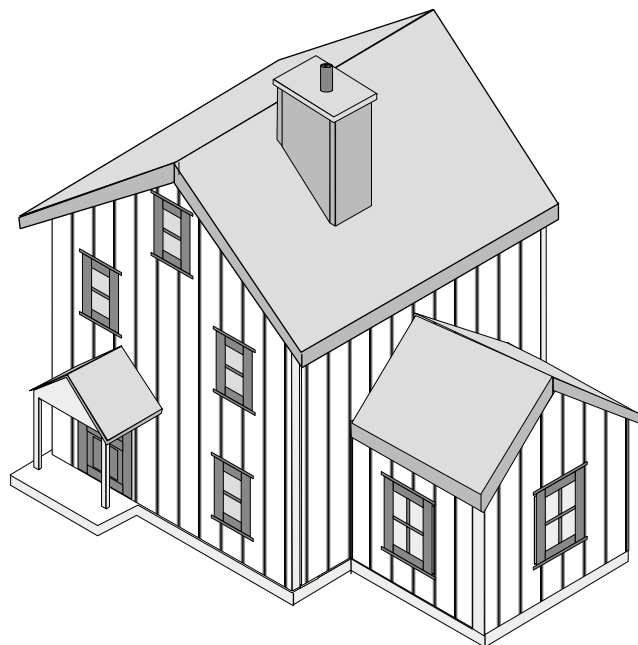
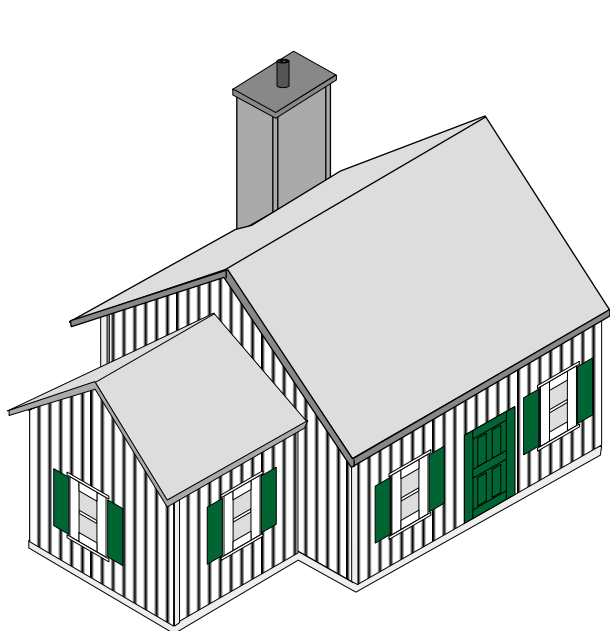

The following illustrations will show assembly of two 45° roof houses; a one story and a two story. The length of the sidewalls doesn't matter. Instructions apply to both houses unless noted otherwise. The specific instructions will be in boxes.

1 Story House  
with room addition,  
and ground  
chimney

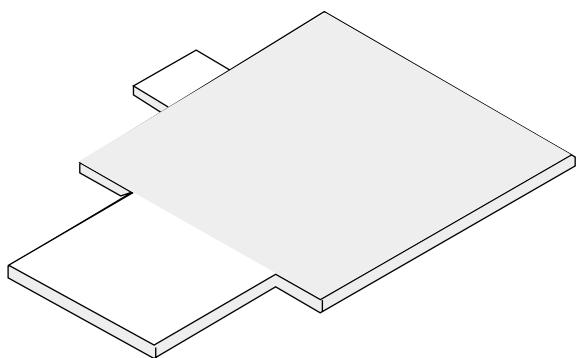

2 Story House  
with room addition,  
porch and rooftop  
chimney

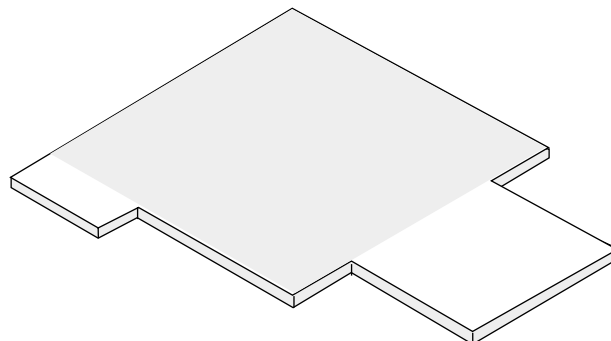

- 1.** The Foundation  
Using your Basic Foundation plans and any additions you have decided upon, cut out the Total House Foundation. (For illustration only, the Basic Foundation area is shaded.)



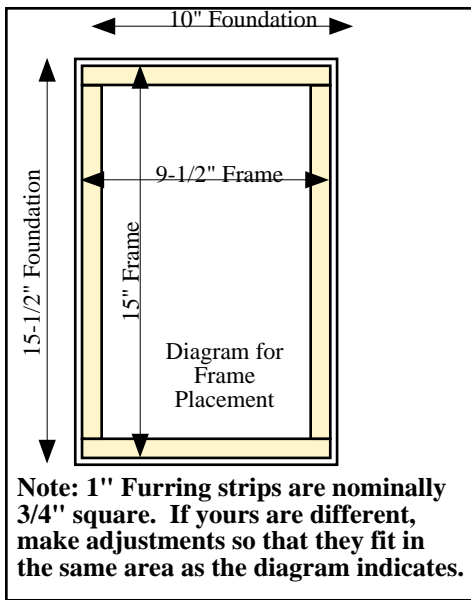

**Reminder:**  
 Do not cut openings in bottom frame if using Garden Town or other non-opening doors

**2.** Bottom Frame  
 Refer to the Diagram for Frame Placement

- With ruler and pencil measure and mark 1/4" inside the foundation. (For depth of the walls)

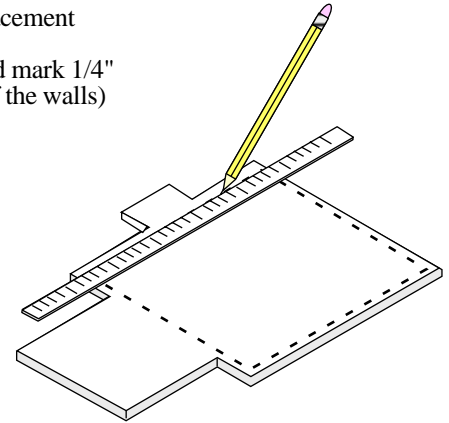

**3.**

- Lay the Frame pieces out on the foundation and make sure they fit inside the 1/4" lines.
- If you are using opening doors, cut out appropriate spaces wherever you wish to place the doors.
- Glue bottom frame in place one piece at a time. Immediately go to step 3A.

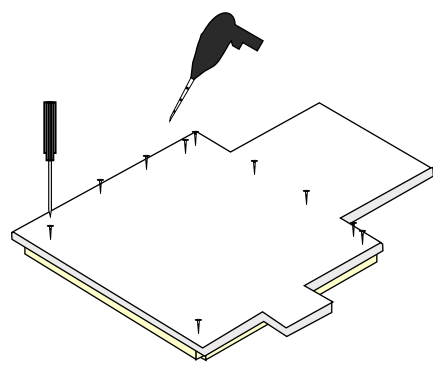
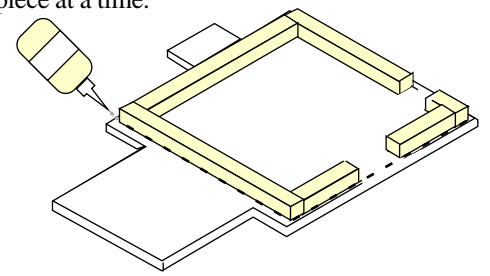

**3A.**

- To strengthen the assembly:
- Flip the foundation assembly over to the back.
  - Drill small pilot holes through the foundation and the frame pieces. Insert small flat head wood screws to hold the frame in place.
- Be sure to maintain right angles at corners*

**4.** Top Frame

- Lay the pieces out on a flat surface, using continuous pieces. (No openings for doors.) The overall dimensions will be the same as the bottom frame
- Glue and nail or staple the top frame together, again maintaining corner angles.

Check Alignment of Horizontal Braces

- Position the Top Brace over the Bottom Brace to ensure that the two pieces are in alignment.
- The two braces should line up vertically and be the same dimensions on all sides. If they don't line up, double check your work and make adjustments. (Favorite thing to do)

- Then lay the Top Brace aside.

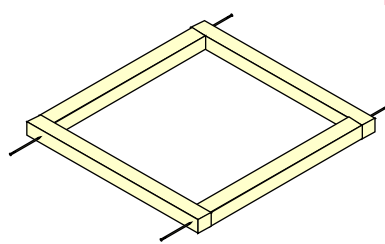

(1 story house illustrated)

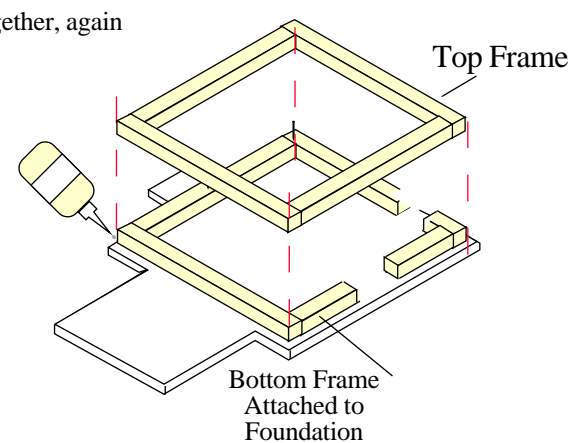

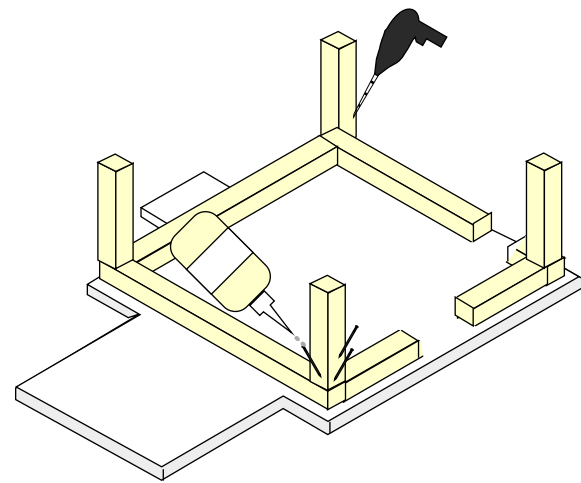

1 Story

**5.** Vertical Studs  
 Each wall needs a vertical stud on each end. Lightly glue and nail or staple a vertical stud at each corner for the walls to be attached to.

Note: Nailing the studs in place will be much easier if you begin with drilling a small pilot hole for the nail.

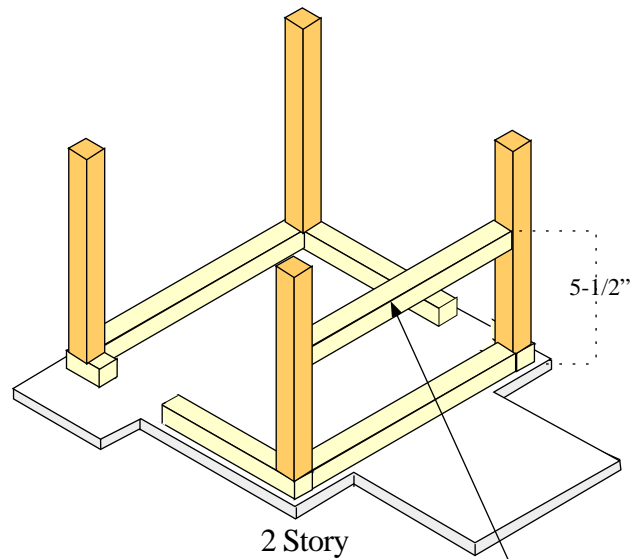

2 Story

**2 Story only**  
 If you are building a two story house with a room addition, you can add an additional horizontal brace to your frame. Cut it the same length as the upper and lower braces on that side.

Measure and place the top of the brace at 5-1/2" above the foundation.

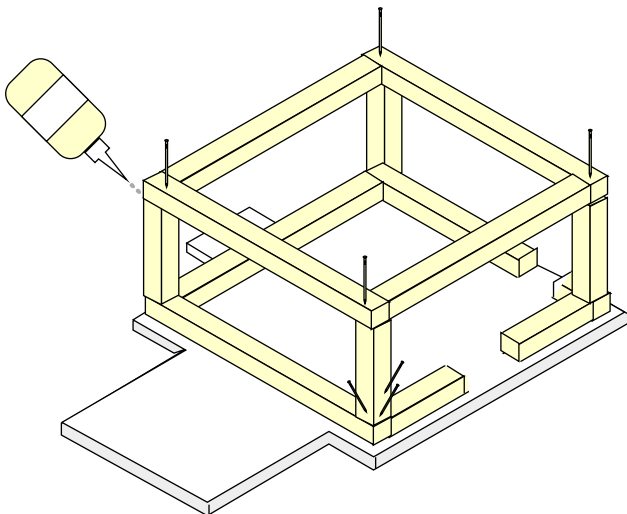

1 Story

**6.** Lightly glue the tops of the vertical studs. Place the assembled top brace on top of the vertical studs, matching up with the bottom brace. Nail or staple the top brace to all vertical studs.

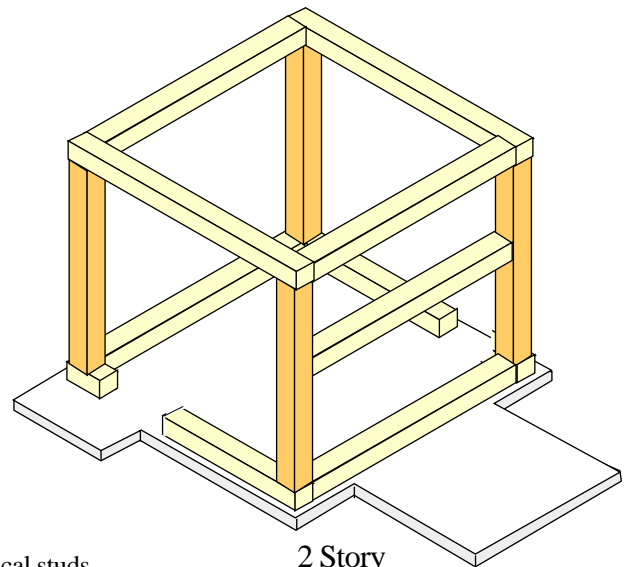

2 Story

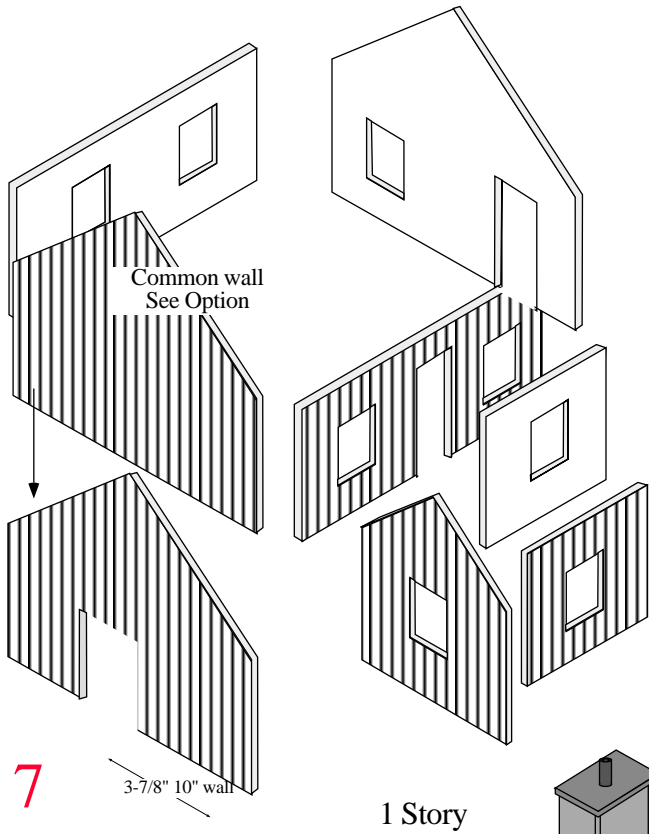

1 Story

**Common Wall Option**  
 For adding inside lights to your house:  
 On common wall which the addition will attach to -  
 cut out an inside doorway to correspond with your room addition. Center the doorway.  
 Make the doorway 2-1/4" w x 4" h.  
 This opening will not be fitted with a door but will allow the light to flow through the entire house. You won't have to cut into the bottom frame for this wall.

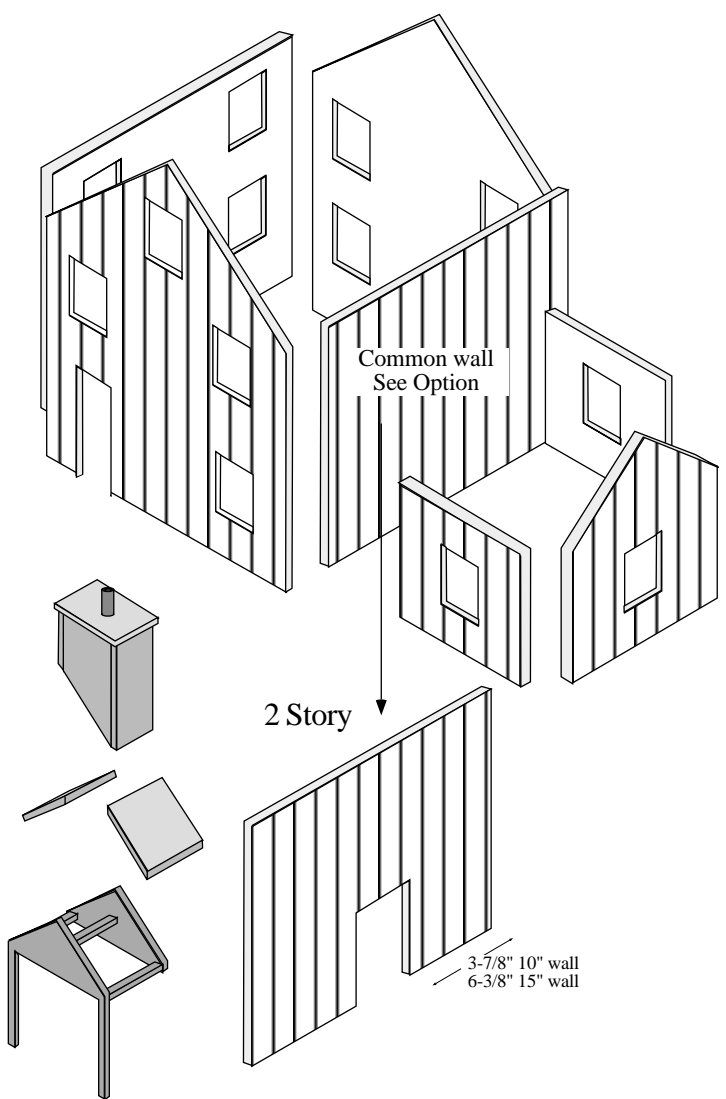

2 Story

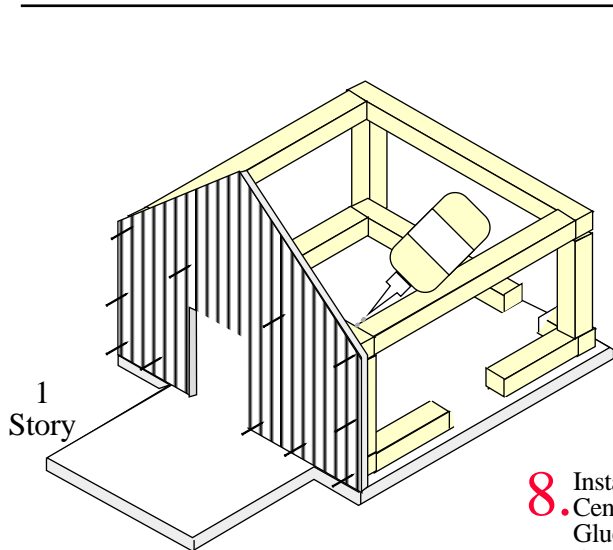

1 Story

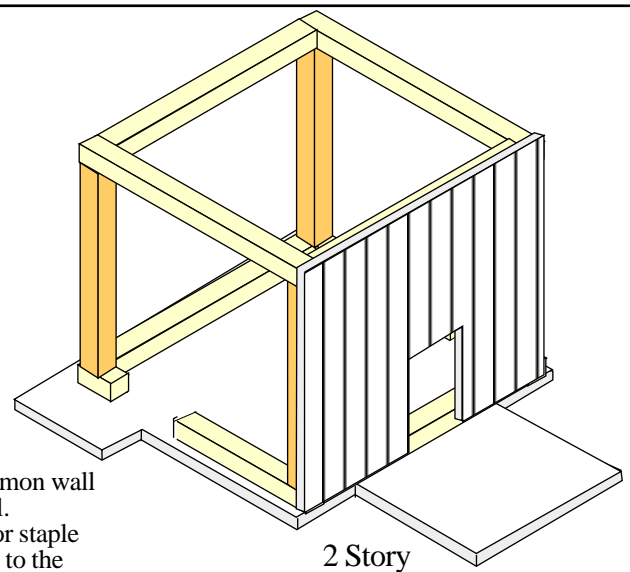

2 Story

**8.** Install the common wall  
 Center the wall.  
 Glue and nail or staple  
 the wall firmly to the  
 frame.

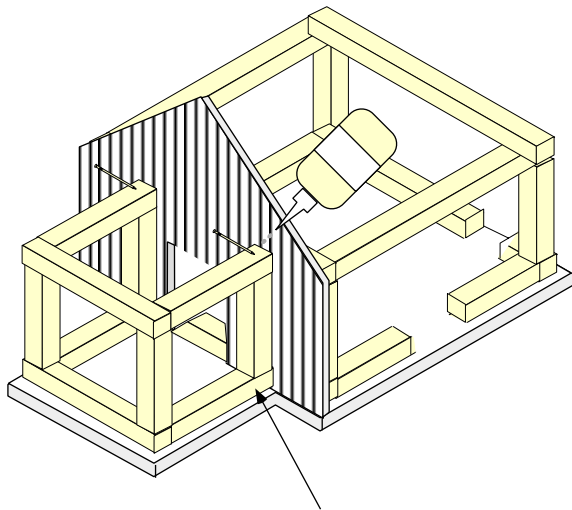

1 Story

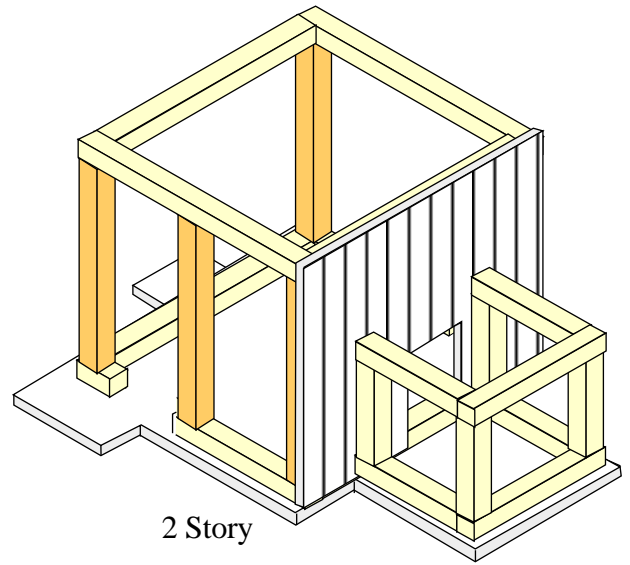

2 Story

9. Using the same rules as you used for the house frame, build up the room addition frame. (Attach the bottom parts to the foundation. Then the vertical braces and top frame.)  
Glue and nail the frame top to the common wall and top house brace.

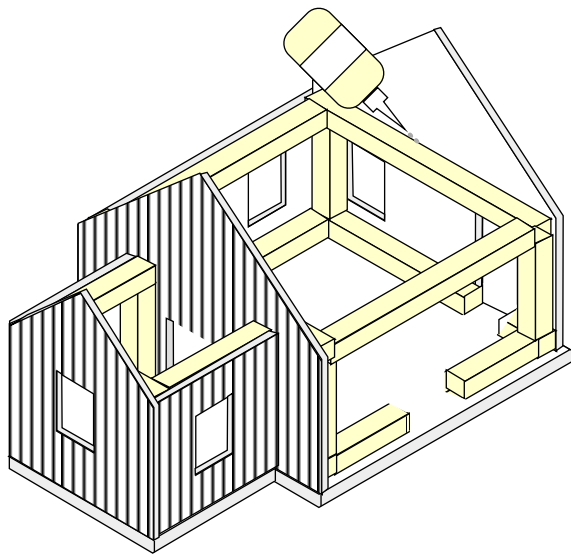

1 Story

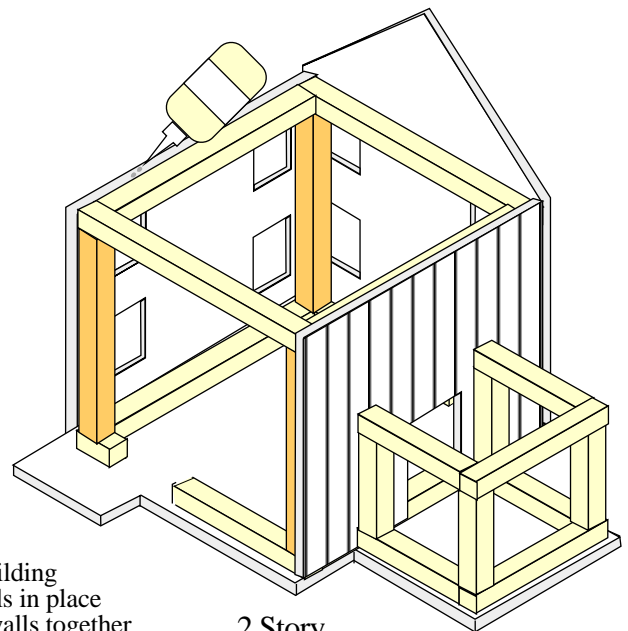

2 Story

10. Start at one end of building and nail or staple walls in place to the frame. Work walls together in a clockwise or counterclockwise direction. Direction doesn't matter. Just fit the adjacent walls and keep going in the same direction.

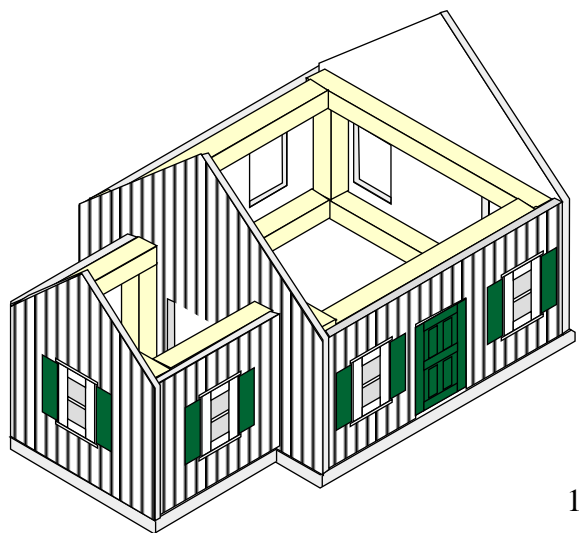

1 Story

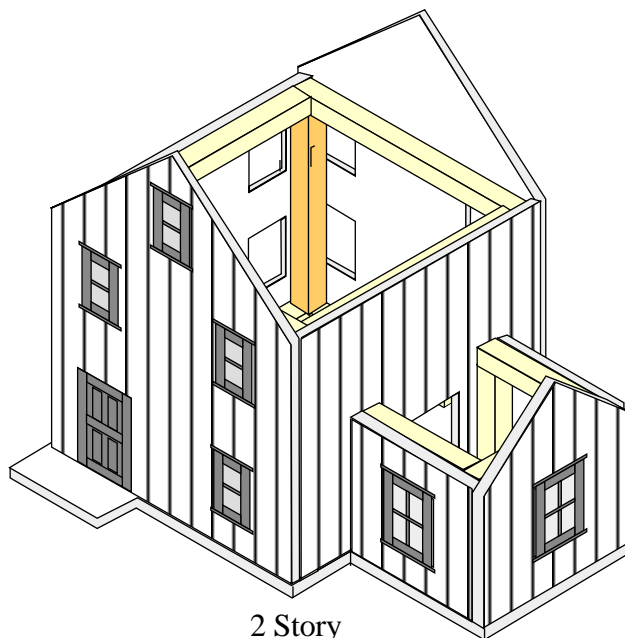

2 Story

**11.**

Continue adding walls until all walls are in place. Always nail or staple into the frame. Check that each wall is sturdily attached and that there are no "floppy" walls.

**Install your doors and windows before adding the porch or the roof.**  
See Assembly - Walls

Note:  
1 Story house an not have a porch on the side wall because the house roofline is too low. If you install a porch on the end wall, use one of the foundations with porch floor. Attach in the same manner as the two story illustration.

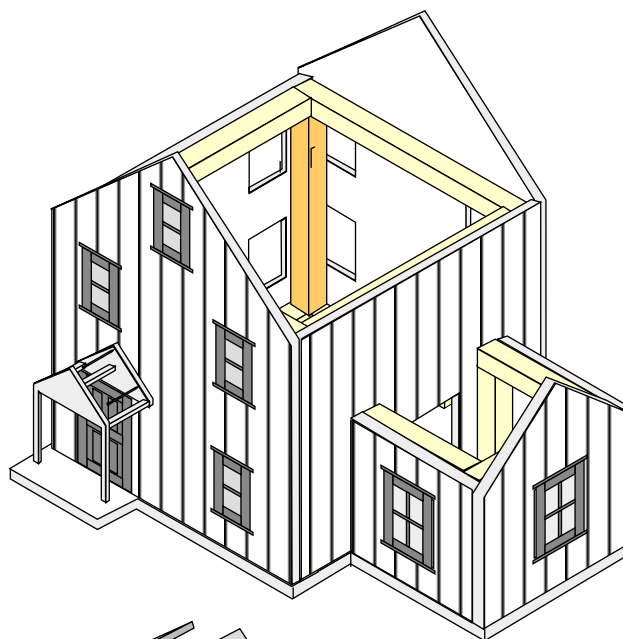

**12.**

Position and attach the porch frame to the house wall. Be sure to secure the posts to the foundation. When dry, carefully center and attach the porch roof.

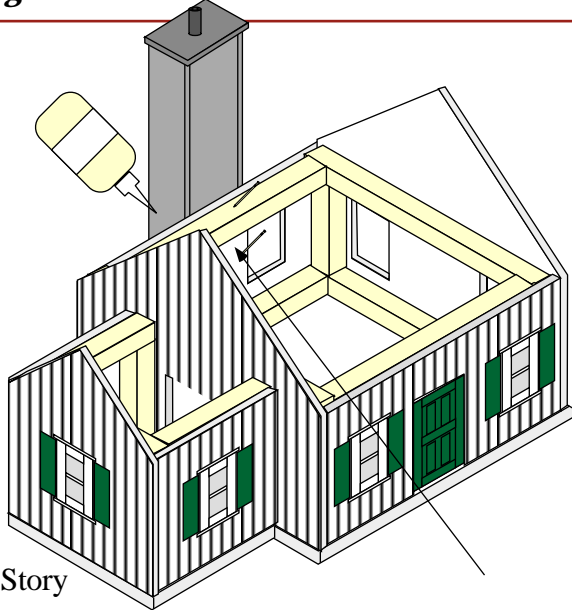

1 Story

- 13.** Ground Chimney shown on 1 Story House  
 Glue the assembled ground chimney to the chimney foundation and the side of the house. Secure with nails or staples from the inside of the wall.

**Note: If you are adding lights to your house, use screws to attach the roof. This will enable you to have access to the wiring.**

Roof half for ground chimney is notched to fit around chimney.

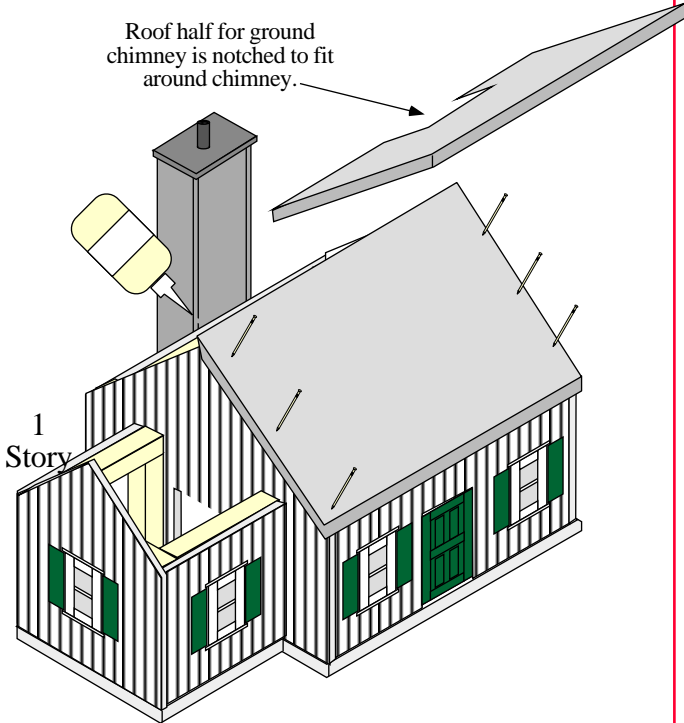

1 Story

- 14.** •Run a bead of glue around the exposed wood that the roof will sit on as well as the inside tops of the roof halves where they join.  
 •One at a time, carefully center one roof half in place. Glue and nail or staple to the building, nailing into the frame. Match up the second half and secure in the same manner, making certain that the roof tops are lined up.

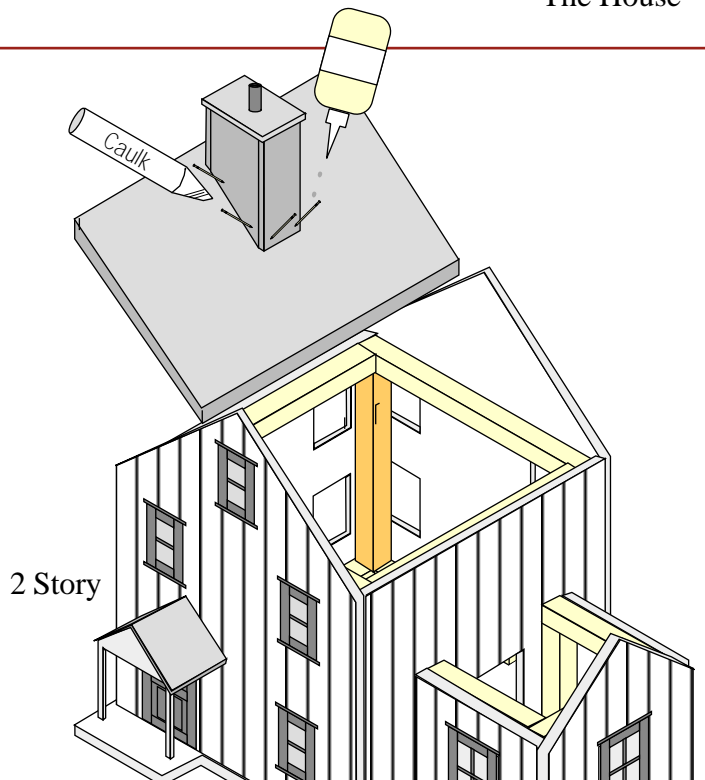

2 Story

- 13.** Rooftop Chimney shown on 2 Story House  
 Reminder: Don't place the chimney directly above a door or window opening. You can attach the assembled chimney to the roof before or after you attach the roof to the house. Run a bead of glue on the bottom side of the chimney frame and attach with small nails or staples. You may want to caulk around the outside bottom of the chimney to ensure a good seal.

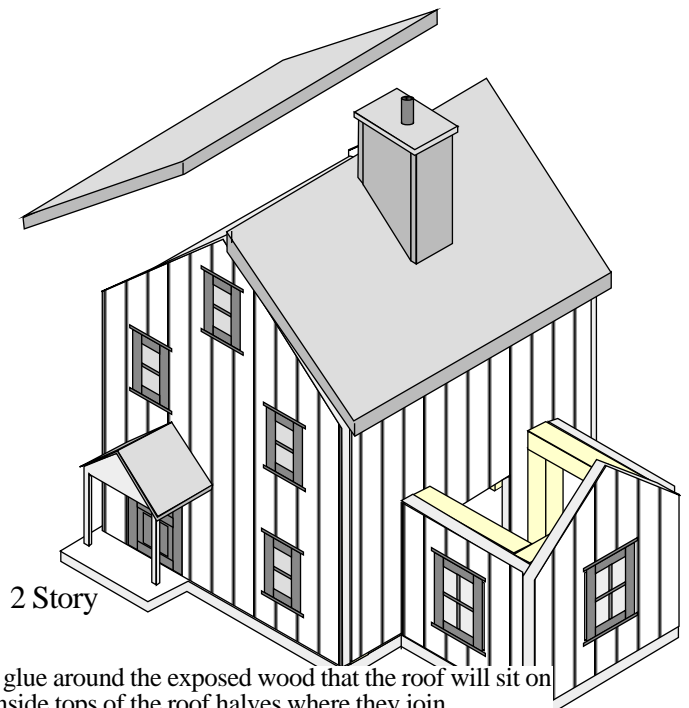

2 Story

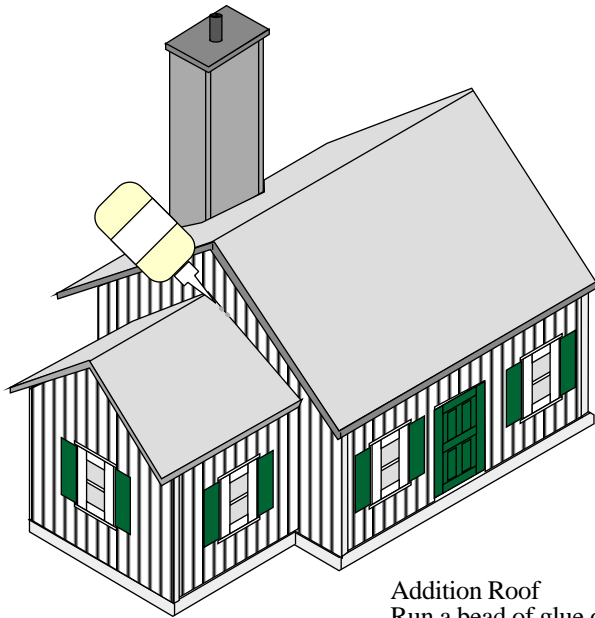

1 Story

15.

**Addition Roof**  
Run a bead of glue on all exposed areas of the addition where roof will touch. Also glue the inside top halves of the roof where they will join and the ends which will fit against the house.  
Carefully place the one half of the addition roof onto the addition .  
Secure with glue. Place the other half of the roof.  
Line up the roof lines at the top and overhangs. Make sure there are no gaps between the two roofs. You may have to do a minimal amount of trimming at the overhang to get a smooth finish.  
Nail or staple the roof halves in place.  
Hint:  
If there is a small gap just run some caulking down the "seams".  
Then if you paint the roof, paint over the caulking when dry.  
If you add wooden or other type shingles, the shingles will cover the caulking.

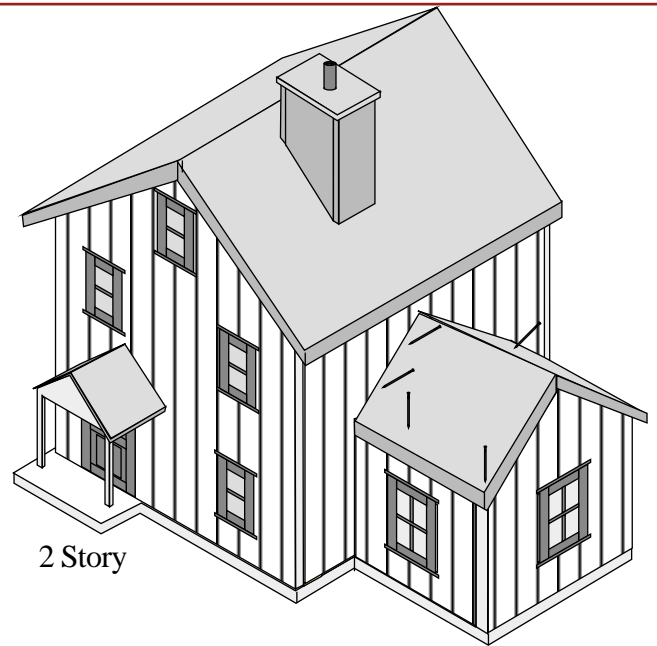

2 Story

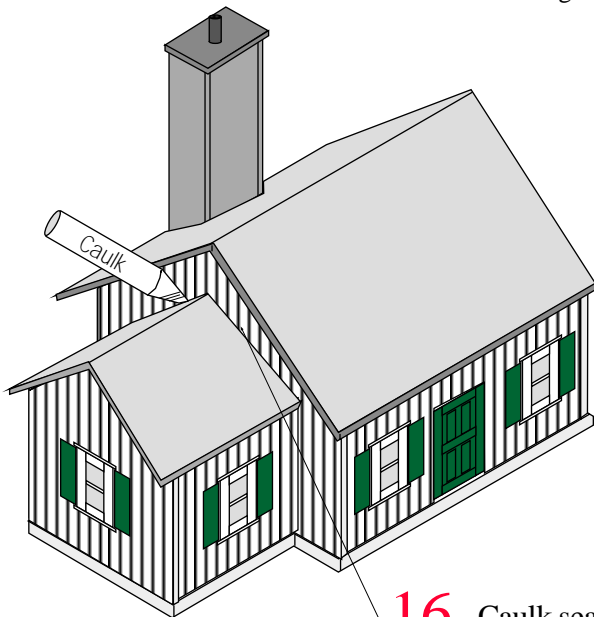

1 Story

16. Caulk seams if needed.

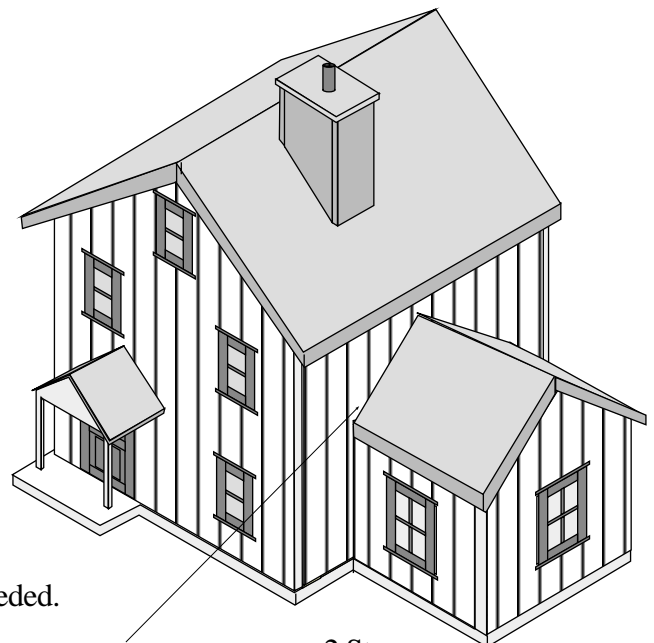

2 Story